

Contains

Operating Manual

for

DIGITAL & VECTOR SIGNAL GENERATORS 2050 SERIES

**Part number 46882-237W
Issue 10**

Creation date 24-Jun-98

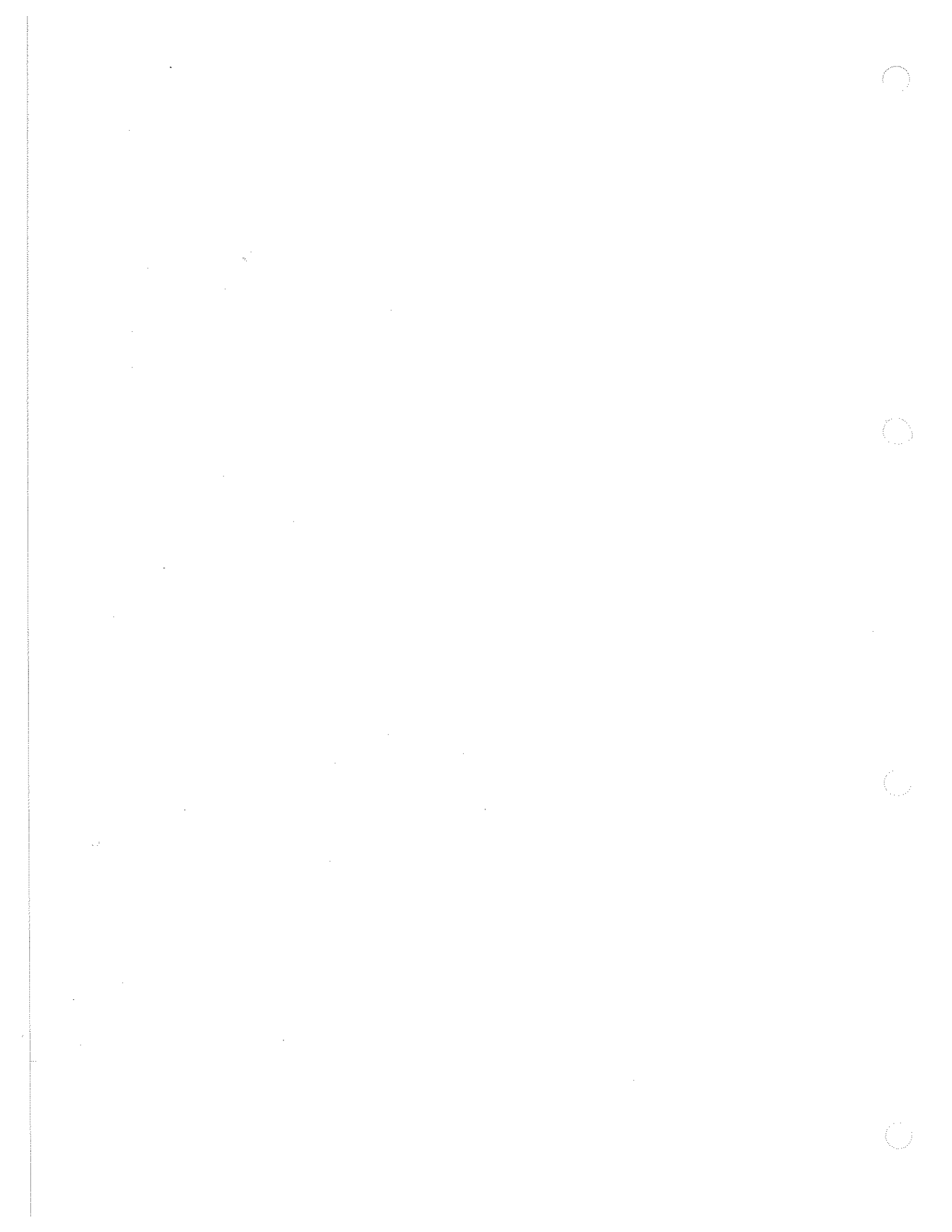

CUSTOMER QUESTIONNAIRE

Please spare a moment to detach, complete and return the Questionnaire on the next page. Your comments and suggestions will help us improve our products.

If you have had any problems with this product, please contact our Customer Support Help Desk on 01438-772008 at Stevenage if you are in the UK, or your Local Service Centre if outside the UK. The address and telephone number of your Local Service Centre is listed in this manual.

Please put the completed form in the addressed envelope provided and mail.

End User details

Name		
Company Name		
Company Address		
Country	Post Code	Fax no.
Telephone No		Ext.

Equipment details

Part nos	Serial nos	Software Issues
Name & Address of Purchaser (if different from above)		
Delivery Date	Do you have a Maintenance Contract?	<input type="checkbox"/> Yes <input type="checkbox"/> No

Equipment Condition

Was the equipment in perfect working order when delivered?		<input type="checkbox"/> Yes <input type="checkbox"/> No
If the answer to the above question was 'no', was the problem to do with		
mechanical condition (damaged case etc.)	<input type="checkbox"/>	Severity Critical <input type="checkbox"/> Major <input type="checkbox"/> Minor <input type="checkbox"/>
suspected hardware fault	<input type="checkbox"/>	
suspected software fault	<input type="checkbox"/>	
did not meet its specification.	<input type="checkbox"/>	
Please tick the relevant item and describe below;		Repeatable? Yes <input type="checkbox"/> No <input type="checkbox"/> Occasionally <input type="checkbox"/>
<i>(continue in blank space on previous page if necessary)</i>		

Claim under Guarantee

If you have had problems,

have you already claimed under the Guarantee Yes No

or do you intend to claim under Guarantee? Yes No

Improvements

We should like to receive any suggestions for improvements or applications of this or other products that you may have. Please add them below or include them on an extra sheet.

(continue in blank space on previous page if necessary)

IFR Action

	Initial/Date	Initial/Date	Initial/Date
Copy to Comm. Admin.		Distributor contacted	Problem established
Service Dept response		Follow through needed	Cleared

DIGITAL & VECTOR SIGNAL GENERATORS

2050 SERIES

2050 10 kHz to 1.35 GHz
2051 10 kHz to 2.7 GHz
2052 10 kHz to 5.4 GHz

Includes information on:

- Option 001 - Second modulation oscillator
- Option 002 - Pulse modulation
- Option 006 - Avionics
- Option 008 - RF profiles and complex sweep
- Option 012 - Electronic attenuator
- Option 100 - Single fuse version
- Option 105 - Modified pulse modulator
- Option 112 - EXT MOD 2 input 600 Ω

This manual applies to instruments with software issues of 9.07 and higher.

© IFR Ltd. 1998

No part of this book may be reproduced or transmitted in any form or by any means, electronic or mechanical, including photocopying, or recorded by any information storage or retrieval system, without permission in writing by IFR Ltd.

Printed in the UK

Manual part no. 46882-237W
Issue 10

24 June 1998



CONTENTS

Tab
numbers

Preface		
Precautions		
Precautions		
Vorsichtsmaßnahmen		
Precauzioni		
Precauciones		
Chapter 1	GENERAL INFORMATION	1
Chapter 2	INSTALLATION	2
Chapter 3-1	OPERATION	3
	Digital modulation mode	4
	Vector modulation mode	5
	Analog modulation mode	6
Chapter 3-2	GPIB OPERATION	7
Chapter 4-1	BRIEF TECHNICAL DESCRIPTION	8
Chapter 5-1	ACCEPTANCE TESTING	9
Appendix A	ACCEPTANCE TESTING SECOND MODULATION OSCILLATOR OPTION	10
Appendix B	ACCEPTANCE TESTING PULSE MODULATION OPTION	11
Appendix C	ACCEPTANCE TESTING ELECTRONIC ATTENUATOR OPTION	12
Annex A	OPTION 006 AVIONICS	13
Annex B	OPTION 008 RF PROFILES AND COMPLEX SWEEP	14
INDEX		15
ADDRESSES		16

PREFACE

PATENT PROTECTION

The 2050 series Digital & Vector Signal Generators are protected by the following patents:

GB 2030391	GB 2214012	
US 4323943	US 4870384	
FR 80.26256	GB 1601822	
GB 2064892	US 4194164	
US 4400630	EP 0125790	
GB 2158999	GB 2140232	
US 4672336	US 4609881	
GB 2217542	GB 2258774	} Instruments fitted with Option 006
US 5061909	US 5375065	
EP 0322139		

PRECAUTIONS

WARNINGS, CAUTIONS and NOTES

These terms have specific meanings in this manual:-



WARNINGS contain information to prevent personal injury.

CAUTIONS contain information to prevent damage to the equipment.

Notes contain important general information.

HAZARD SYMBOLS

The meaning of hazard symbols appearing on the equipment is as follows:

Symbol	Nature of hazard
	General hazard
	Dangerous voltage
	Toxic hazard

SAFETY

This product has been designed and tested in accordance with BS4743 'Specification for safety requirements for electronic measuring apparatus' and IEC Publication 348 'Safety requirements for electronic measuring apparatus'.

WARNING - ELECTRICAL HAZARDS (AC supply voltage)

This equipment conforms with IEC Safety Class I, meaning that it is provided with a protective grounding lead. To maintain this protection the supply lead must always be connected to the source of supply via a socket with a grounded contact.

Be aware that the supply filter contains capacitors that may remain charged after the equipment is disconnected from the supply. Although the stored energy is within the approved safety requirements, a slight shock may be felt if the plug pins are touched immediately after removal.

Do not remove covers, no user serviceable parts inside. See list of IFR Ltd International Service Centres at rear of manual.

Fuses

Note that there are supply fuses in both the live and neutral wires of the supply lead. If only one of these fuses should rupture, certain parts of the equipment could remain at supply potential.

For Option 100, single fuse version only:

Fuses. Note that the internal supply fuse is in series with the live (brown) conductor of the supply lead. If connection is made to a 2-pin unpolarized supply socket, it is possible for the fuse to become transposed to the neutral conductor, in which case, parts of the equipment could remain at supply potential even after the fuse has ruptured.

WARNING - FIRE HAZARD

Make sure that only fuses of the correct rating and type are used for replacement.

If an integrally fused plug is used on the supply lead, ensure that the fuse rating is commensurate with the current requirements of this equipment. See under 'Performance Data' in Chapter 1 for power requirements.

WARNING - TOXIC HAZARDS

Some of the components used in this equipment may include resins and other materials which give off toxic fumes if incinerated. Take appropriate precautions, therefore, in the disposal of these items.

WARNING - Beryllia

Beryllia (beryllium oxide) is used in the construction of some of the components in this equipment.

This material, when in the form of fine dust or vapour and inhaled into the lungs, can cause a respiratory disease. In its solid form, as used here, it can be handled quite safely although it is prudent to avoid handling conditions which promote dust formation by surface abrasion.

Because of this hazard, you are advised to be very careful in removing and disposing of these components. Do not put them in the general industrial or domestic waste or despatch them by post. They should be separately and securely packed and clearly identified to show the nature of the hazard and then disposed of in a safe manner by an authorized toxic waste contractor.

WARNING - LITHIUM

A Lithium battery (or a Lithium battery contained within an IC) is used in this equipment.

As Lithium is a toxic substance, the battery should in no circumstances be crushed, incinerated or disposed of in normal waste.

Do not attempt to recharge this type of battery. Do not short circuit or force discharge since this might cause the battery to vent, overheat or explode.

WARNING - HEAVY EQUIPMENT

The weight of this equipment exceeds the 18 kg (40 lb) guideline for manual handling by a single person. To avoid the risk of injury, an assessment should be carried out prior to handling which takes account of the load, workplace environment and individual capability, in accordance with European Directive 90/269/EEC and associated National Regulations.

WARNING - TILT FACILITY

When the equipment is in the tilt position, it is advisable, for stability reasons, not to stack other equipment on top of it.

CAUTION - PULSE INPUT

Before switching the instrument on, ensure that no signal voltage is present on the PULSE INPUT socket.

CAUTION - STATIC SENSITIVE COMPONENTS

This equipment contains static sensitive components which may be damaged by handling - refer to the Maintenance part of the Service Manual for handling precautions.

PRECAUTIONS

WARNINGS, CAUTIONS et NOTES

Les termes suivants ont, dans ce manuel, des significations particulières:



WARNINGS contient des informations pour éviter toute blessure au personnel.

CAUTIONS contient des informations pour éviter les dommages aux équipements.

Notes contient d'importantes informations d'ordre général.

SYMBOLES SIGNALANT UN RISQUE

La signification des symboles liés à cet équipement est la suivante:

Symbole	Nature du risque
	Risques généraux
	Tension dangereuse
	Danger produits toxiques

SÉCURITÉ

Cet appareil a été conçu et testé conformément aux normes BS4743 "Spécifications des conditions de sécurité pour instruments de mesure électronique" et CEI Publication 348 "Conditions de sécurité pour instruments de mesure électronique".

WARNING - SECURITE ELECTRIQUE

Tension d'alimentation alternative

Cet appareil est protégé conformément à la norme CEI de sécurité class 1, c'est-à-dire que sa prise secteur comporte un fil de protection à la terre. Pour maintenir cette protection, le câble d'alimentation doit toujours être branché à la source d'alimentation par l'intermédiaire d'une prise comportant une borne terre.

Notez que les filtres d'alimentation contiennent des condensateurs qui peuvent encore être chargés lorsque l'appareil est débranché. Bien que l'énergie contenue soit conforme aux exigences de sécurité, il est possible de ressentir un léger choc si l'on touche les bornes sitôt après débranchement.

Ne pas enlever les capots, aucune pièce réparable ne se trouve à l'intérieur. Contacter un des Centres de Maintenance Internationaux de IFR Ltd dans la liste jointe à la fin du manuel.

Fusibles

Notez qu'il y a deux fusibles, l'un pour la phase et l'autre pour le neutre du câble d'alimentation. Si un seul fusible est coupé, certaines parties de l'appareil peuvent rester au potentiel d'alimentation.

Option fusible simple

Notez que le fusible d'alimentation interne est en série avec la phase (fil brun) du câble d'alimentation. Si la prise d'alimentation comporte deux bornes non polarisées, il est possible de connecter le fusible au neutre. Dans ce cas, certaines parties de l'appareil peuvent rester à un certain potentiel même après coupure du fusible.



WARNING - RISQUE LIE AU FEU

Lors du remplacement des fusibles vérifiez l'exactitude de leur type et de leur valeur.

Si le câble d'alimentation comporte une prise avec fusible intégré, assurez vous que sa valeur est compatible avec les besoins en courant de l'appareil. Pour la consommation, reportez-vous au chapitre 1 "Spécifications".



WARNING - DANGER PRODUITS TOXIQUES

Certains composants utilisés dans cet appareil peuvent contenir des résines et d'autres matières qui dégagent des fumées toxiques lors de leur incinération. Les précautions d'usages doivent donc être prises lorsqu'on se débarrasse de ce type de composant.



WARNING - LE BERYLLIA

Le Béryllia (oxyde de Béryllium) entre dans la composition de certains composants de cet appareil.

Cette matière peut, lorsqu'elle est inhalée sous forme de vapeur ou de fine poussière, être la cause de maladies respiratoires. Sous sa forme solide, comme c'est le cas ici, cette matière peut être manipulée sans risque, bien qu'il soit conseillé d'éviter toute manipulation pouvant entraîner la formation de poussière par abrasion de la surface.

Il est donc conseillé, pour éviter ce risque, de prendre les précautions requises pour retirer ces composants et s'en débarrasser. Ne les jetez pas avec les déchets industriels ou domestiques ou ne les envoyez pas par la poste. Il faut les emballer séparément et solidement et bien indiquer la nature du risque avant de les céder, avec précautions, à une entreprise spécialisée dans le traitement de déchets toxiques.



WARNING - LITHIUM

Une batterie au **Lithium** est utilisée pour l'horloge temps réel et se trouve sur le panneau arrière.

Le Lithium est une substance toxique; en conséquence on ne doit l'écraser, l'incinérer ou la jeter dans la "poubelle".

Ne pas essayer de la recharger, ne pas la court-circuiter, une forte décharge rapide risque de provoquer une surchauffe voire l'explosion de celle-ci.



WARNING - INSTRUMENT LOURD

Le poids de cet appareil est supérieur à la limite de 18 kg (40 lb), fixée pour le transport par une seule personne. Afin d'éviter tout risque de blessure, il est nécessaire de faire, avant le transport, une évaluation de la charge, des contraintes de l'environnement et des capacités de l'individu, en conformité avec la Directive Européenne 90/269/EEC ainsi que les recommandations Nationales concernées.



WARNING - POSITION INCLINEE

Lorsque l'appareil est dans une position inclinée, il est recommandé, pour des raisons de stabilité, de ne pas y empiler d'autres appareils.

VORSICHTSMASSNAHMEN

WARNINGS, CAUTIONS und NOTES

Diese Hinweise haben eine bestimmte Bedeutung in diesem Handbuch:



WARNINGS dienen zur Vermeidung von Verletzungsrisiken.

CAUTIONS dienen dem Schutz der Geräte.

Notes enthalten wichtige Informationen.

GEFAHRENSYMBOL

Die Gefahrensymbole auf den Geräten sind wie folgt:

Symbol	Gefahrenart
	Allgemeine Gefahr
	Gefährliche Spannung
	Warnung vor giftigen Substanzen

SICHERHEIT

Dieses Gerät wurde in Übereinstimmung mit BS4743 und IEC 348 entwickelt und geprüft.

WARNING - ELEKTRISCHE SCHLÄGE

Wechselspannungsversorgung

Das Gerät entspricht IEC Sicherheitsklasse 1 mit einem Schutzleiter nach Erde. Das Netzkabel muß stets an eine Steckdose mit Erdkontakt angeschlossen werden.

Filterkondensatoren in der internen Spannungsversorgung können auch nach Unterbrechung der Spannungszuführung noch geladen sein. Obwohl die darin gespeicherte Energie innerhalb der Sicherheitsmargen liegt, kann ein leichter Spannungsschlag bei Berührung kurz nach der Unterbrechung erfolgen.

Entfernen Sie keine Gehäuseabdeckungen, es befinden sich keine austauschbaren Teile im Gerät. Eine Liste der IFR Servicestellen finden Sie auf der Rückseite des Handbuchs.

Sicherungen

Es ist zu beachten, daß es Sicherungen in beiden (spannungsführenden und neutralen) Zuleitungen gibt. Wenn nur eine von diesen Sicherungen schmilzt, so bleiben einige Geräteteile immer noch auf Spannungspotential.

Einsicherungs-Option

Die interne Sicherung in der Spannungszuführung ist in Reihe mit der spannungsführenden Zuleitung (braun) geschaltet. Bei Verbindung mit einer zweiadrigen, nicht gepolten Steckdose kann die Sicherung in der Masseleitung liegen, so daß auch bei geschmolzener Sicherung Geräteteile immer noch auf Spannungspotential sind.



WARNING - FEUERGEFAHR

Es dürfen nur Ersatzsicherungen vom gleichen Typ mit den korrekten Spezifikationen entsprechend der Stromaufnahme des Gerätes verwendet werden. Siehe hierzu die Leistungsdaten (Performance Data) in Kapitel 1.



WARNING - WARNUNG VOR GIFTIGEN SUBSTANZEN

In einigen Bauelementen dieses Geräts können Epoxyharze oder andere Materialien enthalten sein, die im Brandfall giftige Gase erzeugen. Bei der Entsorgung müssen deshalb entsprechende Vorsichtsmaßnahmen getroffen werden.



WARNING - BERYLLIUM OXID

Beryllium Oxid wird in einigen Bauelementen verwendet.

Als Staub inhaliert kann Beryllium zu Schädigungen der Atemwege führen. In fester Form kann es ohne Gefahr gehandhabt werden, wobei Staubabrieb vermieden werden sollte.

Wegen dieser Gefahren dürfen diese Bauelemente nur mit der entsprechenden Vorsicht ausgebaut und entsorgt werden. Sie dürfen nicht mit Industrie oder Hausmüll vermengt oder per Post versandt werden. Sie müssen separat verpackt und entsprechend der Gefährdung markiert werden. Die Entsorgung muß über einen autorisierten Fachbetrieb erfolgen.



WARNING - LITHIUM

Die für die Echtzeituhr erforderliche **Lithium**batterie ist an der Geräterückseite eingebaut.

Da Lithium ein giftiges Material ist, sollte es als Sondermüll entsorgt werden.

Diese Batterie darf auf keinen Fall geladen werden. Nicht kurzschließen, da sie dabei überhitzt werden und explodieren kann.



WARNING - SCHWERES GERÄT

Das Gewicht dieses Geräts liegt über der 18 kg (40 lb) Grenze für Transport durch eine einzelne Person. Zur Vermeidung von Verletzungen sollten vor einem Transport die Arbeitsumgebung und die persönlichen Möglichkeiten im Verhältnis zur Last abgewogen werden, wie in der EU-Regelung 90/269/EEC und nationalen Normen beschrieben.



WARNING - SCHRÄGSTELLUNG

Bei Schrägstellung des Geräts sollten aus Stabilitätsgründen keine anderen Geräte darauf gestellt werden.

PRECAUZIONI

WARNINGS, CAUTIONS e NOTES

Questi termini vengono utilizzati in questo manuale con significati specifici:



WARNINGS riportano informazioni atte ad evitare possibili pericoli alla persona.

CAUTIONS riportano informazioni per evitare possibili pericoli all'apparecchiatura.

Notes riportano importanti informazioni di carattere generale.

SIMBOLI DI PERICOLO

Significato dei simboli di pericolo utilizzati nell'apparato:

Simbolo	Tipo di pericolo
	Pericolo generico
	Tensione pericolosa
	Pericolo sostanze tossiche

SICUREZZA

Questo prodotto è stato progettato e provato secondo le norme BS4743 "Specification for safety requirements for electronic measuring apparatus" e la pubblicazione IEC 348 "Safety requirements for electronic measuring apparatus".



WARNING - PERICOLI DA ELETTRICITÀ

Alimentazione c.a.

Quest' apparato è provvisto del collegamento di protezione di terra e rispetta le norme di sicurezza IEC, classe 1. Per mantenere questa protezione è necessario che il cavo, la spina e la presa d'alimentazione siano tutti provvisti di terra.

Il circuito d'alimentazione contiene dei filtri i cui condensatori possono restare carichi anche dopo aver rimosso l'alimentazione. Sebbene l'energia immagazzinata è entro i limiti di sicurezza, purtuttavia una leggera scossa può essere avvertita toccando i capi della spina subito dopo averla rimossa.

Non rimuovere i coperchi, utilizzare solo parti di scorta originali. Vedi elenco internazionale dei Centri di Assistenza in fondo al manuale.

Fusibili

Notare che entrambi i capi del cavo d'alimentazione sono provvisti di fusibili. In caso di rottura di uno solo dei due fusibili, alcune parti dello strumento potrebbero restare sotto tensione.

Opzione singolo fusibile

Se hace notar que el fusible de alimentación interno está en serie con el activo (marrón) del cable de alimentación a red. Si la clavija de alimentación de red cuenta con sólo dos terminales sin polaridad, el fusible puede pasar a estar en serie con el neutro, en cuyo caso existen partes del equipo que permanecerían a tensión de red incluso después de que el fusible haya fundido.



WARNING - PERICOLO D'INCENDIO

Assicurarsi che, in caso di sostituzione, vengano utilizzati solo fusibili della portata e del tipo prescritto.

Se viene usata una spina con fusibili, assicurarsi che questi siano di portata adeguata coi requisiti di alimentazione richiesti dallo strumento. Tali requisiti sono riportati nel cap. 1 "Performance data".



WARNING - PERICOLO SOSTANZE TOSSICHE

Alcuni dei componenti usati in questo strumento possono contenere resine o altri materiali che, se bruciati, possono emettere fumi tossici. Prendere quindi le opportune precauzioni nell'uso di tali parti.



WARNING - BERILLIO

Berillio (ossido di berillio) è utilizzato nella costruzione di alcuni componenti di quest'apparato.

Questo materiale, se inalato sotto forma di polvere fine o vapore, può causare malattie respiratorie. Allo stato solido, come è usato qui, può essere maneggiato con sufficiente sicurezza anche se è prudente evitare condizioni che provochino la formazione di polveri tramite abrasioni superficiali.

A cause di questi pericoli occorre essere molto prudenti nella rimozione e nella locazione di questi componenti. Questi non devono essere gettati tra i rifiuti domestici o industriali né vanno spediti per posta. Essi devono essere impacchettati separatamente ed in modo sicuro e devono indicare chiaramente la natura del pericolo e quindi affidate a personale autorizzato.



WARNING - LITIO

Una batteria al litio, alloggiata nel pannello posteriore, è utilizzata per alimentare il "Real Time Clock".

Poiché il litio è una sostanza tossica, la batteria non deve essere mai né rotta, né incenerita, né gettata tra i normali rifiuti.

Questo tipo di batteria non può essere sottoposto né a ricarica né a corto-circuito o scarica forzata. Queste azioni possono provocare surriscaldamento, fuoriuscita di gas o esplosione della batteria.



WARNING - STRUMENTO PESANTE

Il peso di questo strumento supera i 18 kg (40 lb) raccomandati come limite per il trasporto manuale da parte di singola persona. Per evitare rischi di danni fisici è bene quindi considerare il carico complessivo, le condizioni del trasporto e le capacità individuali in accordo con la direttiva comunitaria 90/269/EEC e con eventuali regolamenti locali.



WARNING - POSIZIONAMENTO INCLINATO

Quando lo strumento è in posizione inclinata è raccomandato, per motivi di stabilità, non sovrapporre altri strumenti.

PRECAUCIONES

WARNINGS, CAUTIONS y NOTES

Estos términos tienen significados específicos en este manual:



WARNINGS contienen información referente a prevención de daños personales.

CAUTIONS contienen información referente a prevención de daños en equipos.

Notes contienen información general importante.

SÍMBOLOS DE PELIGRO

Los significados de los símbolos de peligro que aparecen en los equipos son los siguientes:

Símbolo	Naturaleza del peligro
	Peligro general
	Voltaje peligroso
	Aviso de toxicidad

SEGURIDAD

Este producto ha sido diseñado y probado según las normas, BS4743 'Especificaciones de los requisitos de seguridad para instrumentos electrónicos de medida' e IEC publicación 348 'Requisitos de seguridad para instrumentos electrónicos de medida'.



WARNING - NIVEL PELIGROSO DE ELECTRICIDAD

Tensión de red

Este equipo cumple las normas IEC Seguridad Clase 1, lo que significa que va provisto de un cable de protección de masa. Para mantener esta protección, el cable de alimentación de red debe de conectarse siempre a una clavija con terminal de masa.

Tenga en cuenta que el filtro de red contiene condensadores que pueden almacenar carga una vez desconectado el equipo. Aunque la energía almacenada está dentro de los requisitos de seguridad, pudiera sentirse una ligera descarga al tocar la clavija de alimentación inmediatamente después de su desconexión de red.

No quitar las tapas, en el interior no existen piezas reemplazables por el usuario. Vea la lista de Centros de Servicios Internacionales en la parte trasera del manual.

Fusibles

Se hace notar que el Equipo está dotado de fusibles tanto en el activo como el neutro de alimentación. Si sólo uno de estos fusibles fundiera, existen partes del equipo que pudieran permanecer a tensión de red.

Opción fusible único

Se hace notar que el fusible de alimentación interno está en serie con el activo (marrón) del cable de alimentación a red. Si la clavija de alimentación de red cuenta con sólo dos terminales sin polaridad, el fusible puede pasar a estar en serie con el neutro, en cuyo caso existen partes del equipo que permanecerían a tensión de red incluso después de que el fusible haya fundido.



WARNING - PELIGRO DE INCENDIO

Asegúrese de utilizar sólo fusibles del tipo y valores especificados como recuento.

Si se utiliza una clavija con fusible incorporado, asegúrese de que los valores del fusible corresponden a los requeridos por el equipo. Ver sección de especificaciones del capítulo 1 para comprobar los requisitos de alimentación.



WARNING - AVISO DE TOXICIDAD

Alguno de los componentes utilizados en este equipo pudieran incluir resinas u otro tipo de materiales que al arder produjeran sustancias tóxicas. Por tanto, tome las debidas precauciones en la manipulación de esas piezas.



WARNING - BERILIO

Berilio (óxido de berilio) Este material es utilizado en la fabricación de alguno de los componentes de este equipo.

La inhalación de este material, en forma de polvo fino o vapor, entrando en los pulmones, puede ser causa de enfermedades respiratorias. En forma sólida, como se utiliza en este caso, puede manipularse con bastante seguridad, aunque se recomienda no manejarlo en aquellas condiciones que pudieran favorecer la aparición de polvo por abrasión de la superficie.

Por todo lo anterior, se recomienda tener el máximo cuidado al reemplazar o deshacerse de estos componentes, no tirándolos en basuras industriales o domésticas y no utilizar el correo para su envío. Deben, ser empaquetados de forma segura y separada, y el paquete debidamente etiquetado e identificado, señalando claramente la naturaleza del riesgo y ponerlo a disposición de un destructor autorizado de productos tóxicos.



WARNING - LITIO

Se utiliza una batería de **litio** para mantener el reloj en tiempo real y se halla ubicada en el panel trasero.

Dada que el litio es una sustancia tóxica las baterías de este material no deben ser aplastadas, quemadas o arrojadas junto a basuras ordinarias.

No trate de recargar este tipo de baterías. No las cortocircuite o fuerce su descarga ya que puede dar lugar a que la esta emita gases, se recaliente o explote.



WARNING - INSTRUMENTO PESADO

El peso de este instrumento excede de los 18 Kg (40 lb), lo que debe tenerse en cuenta si va ser transportado manualmente por una sola persona. Para evitar el riesgo de lesiones, antes de mover el equipo deberá evaluar la carga, el entorno de trabajo y la propia capacidad, de acuerdo con la Directiva Europea 90/269/EEC y el Reglamento Nacional Asociado.



WARNING - TENER EN CUENTA CON EL EQUIPO INCLINADO

Si utiliza el equipo en posición inclinada, se recomienda, por razones de estabilidad, no apilar otros equipos encima de él.



Chapter 1

GENERAL INFORMATION

CONTENTS

	PAGE
INTRODUCTION	1-2
MAIN FEATURES	1-2
Operation	1-2
Display	1-3
Frequency selection	1-3
Output	1-3
Modulation	1-3
Vector modulation	1-4
Digital modulation	1-4
Incrementing	1-5
Sweep	1-5
Non-volatile memory	1-5
Programming	1-6
Software protection	1-6
Spectral purity	1-6
Calibration	1-6
Options	1-6
PERFORMANCE DATA	1-8
VERSIONS, OPTIONS AND ACCESSORIES	1-20

LIST OF FIGURES

Fig. 1-1 Typical phase noise performance of 2050 Series in non-digital and -vector modes.....	1-7
--	-----

INTRODUCTION

The 2050 series Digital and Vector Signal Generators offer a wide range of analog and digital modulation facilities covering the frequency ranges 10 kHz to 5.4 GHz with three models: 2050 (10 kHz to 1.35 GHz), 2051 (10 kHz to 2.7 GHz) and 2052 (10 kHz to 5.4 GHz). A dot matrix display with soft key selected screen options allow flexibility of operation and ease of use. The output can be modulated by conventional analog methods - amplitude, frequency, phase and pulse modulation (optional). Digital and vector modulation in PSK, QAM, FSK, GMSK and IQ formats are available and these signals can be modulated to simulate a faded signal environment.

Available options include a second built-in modulation source; avionics modulation (ILS and VOR); pulse modulation; RF level profiling and complex sweep; electronic attenuator.

Microprocessor control ensures that the instruments are flexible and easy to use and allows programming by the General Purpose Interface Bus (GPIB). The GPIB is designed to IEEE Standard 488.2 and is a means of sending commands to an instrument, via a data bus, from a remote controller or personal computer. The instruments can therefore be used manually or as part of a fully automated test system.

These instruments are suitable for a wide range of applications including the testing of new digital communication systems.

MAIN FEATURES

The 2050 series provide the following capabilities:

- Digital and vector modulation capabilities
- I and Q modulation to 10 MHz
- Wide carrier frequency range
- External digital input to 34 ksymbols/sec
- Excellent accuracy and stability
- Rician and Rayleigh fading simulation
- Envelope control for generating RF bursts
- Internal PRBS source
- Programmable channel filter characteristics
- Programmable data rate
- Pre-programmed standard formats such as NADC, PDC, TETRA, APCO25, POCSAG, ERMES, MOBITEX, CDPD, INMARSAT-M, VDR and GSM
- Full AM, FM, Φ M capability
- Wideband DC coupled FM for FSK

Operation

Selection of parameters on the screen may involve one or more of the numeric, hard or soft keys or the rotary knob. Hard keys have single or dual functions which remain constant throughout, whereas soft keys have functions dependent on the present mode of operation. Parameters may be set to specific values by numeric key entry, while values may be varied in steps of any size using the \uparrow/\downarrow keys or altered by moving the knob, set to a particular sensitivity.

The SIG GEN, LF, SWEEP, MEM (memory), Δ (delta) and UTIL (utility) menus are selectable, at any point of operation, via the keys below the display panel. Within the display, the soft key functions are indicated by labels which appear alongside the keys situated at either side of the display panel.

Display

The display is a dot matrix liquid crystal panel, with backlighting. Carrier frequency, modulation and RF level are shown in horizontal regions on the principal screen. The display features 11-digit resolution for carrier frequency, 4-digit for RF level and 3-digit for modulation, with unit annunciators.

Display contrast may be varied, using the control knob, to optimize the viewing angle. Differing lighting conditions may be accommodated using the backlight intensity function, variable from no backlight to full intensity. A full graphical display test is available, refer to the Service Manual.

Frequency selection

Carrier frequency is selected via the soft key option on the SIG GEN display and direct entry via the keyboard. Alternatively, selection may be made via the General Purpose Interface Bus (GPIB). Frequency resolution is 0.1 Hz across the band. Carrier frequencies can be stored in a non-volatile memory with complete recall when required. An ON-OFF key is provided to completely disable the output.

Output

RF output up to +13 dBm (+6 dBm (PEP) in digital and vector modes) can be set by direct keyboard entry with a resolution of 0.1 dB or better over the entire range.

An extended hysteresis facility allows for extended electronic control of RF output level without introducing mechanical attenuator transients when testing squelch systems.

A low intermodulation mode can be selected which disables the RF levelling system and improves the intermodulation performance when combining the outputs of two signal generators.

A choice of calibration units is available to the operator and provision is made for the simple conversion of units (for example, dBm to μV). Calibration data for the output level is held in memory and may be altered from the front panel or over the interface bus.

The output level can be offset by up to ± 2 dB by keyboard entry. Offsets from the calibrated value may be used to compensate for cable or switching losses external to the generator. This facility can be used as a means of deliberately offsetting the output level to ensure that all generators in an area give identical measurements. While using the offsetting facility, the principal calibration of the generator is not lost and may be returned to at any time.

An electronic trip protects the generator output against reverse power of up to 50 W, preventing damage to output circuits when RF or DC power is accidentally applied.

Modulation

Comprehensive amplitude, frequency (plus wide bandwidth FM), phase and optional pulse modulation are combined with an analog IQ (vector) capability. A digital mode of operation uses internal digital signal processing to convert digital data into the complex modulation formats used on modern digital communication systems. An internal modulation oscillator is provided, having a frequency range of 0.1 Hz to 500 kHz, with a resolution of 0.1 Hz. A second modulation oscillator can be included as an option. Two independent BNC inputs on the front panel allow external modulation signals to be mixed with the internal signal(s). Therefore, a maximum of four modulation sources may be available at one time. These sources may be combined to give the single, dual, composite, dual composite and vector and digital modes.

The wide frequency modulation range capability provides a 1 dB bandwidth of 1 MHz and provides FM deviation up to a maximum of 1 MHz for frequencies up to 21 MHz, 1% of carrier frequency elsewhere. Phase modulation is also available with a 10 kHz bandwidth up to a maximum of 10 radians.

Both AC and DC coupled FM is available. In the DC coupled FM mode a patented offset correction system eliminates the large carrier frequency offsets that occur with normal signal generators. As a result the 2050 series signal generators can be used confidently for testing tone and message paging equipment.

Wideband frequency modulation with a 3 dB bandwidth of 10 MHz is provided via a rear panel BNC socket for tests on equipment using frequency shift keying for high speed digital transmission.

Amplitude modulation with a bandwidth of typically greater than 50 kHz and with modulation depths of up to 99.9% is available with a resolution of 0.1%. Pulse modulation is available as an option with typical rise and fall times of 5 ns and 70 dB on/off ratio.

An automatic level control facility is provided for both of the external modulation inputs and provides correctly calibrated modulation for input levels varying from 0.7 to 1.4 V RMS. HI and LO indications show when the input level is outside the range of the ALC system.

The signalling facility allows testing of radio equipment with sequential and sub-audible tone capability. The sequential calling tone system is accessible from the utility menu for all four modulation modes. Sub-audible calling tones are specified within the modulation source select display.

Vector modulation

In vector modulation the generator provides IQ modulation at frequencies from 10 MHz to 1.35 GHz (2050) or to 2.7 GHz (2051 and 2052) by frequency conversion of one of four IFs to the required output frequency. Analog I and Q inputs are provided with a typical bandwidth of 10 MHz.

The wide IQ bandwidth allows the generation of direct sequence spread spectrum signals as well as OFDM and QAM signals for new broadcasting formats.

Precision radar chirp signals can be simulated to test radar receivers using a dual arbitrary waveform generator to provide the required I and Q signals.

A linear envelope input allows for external voltage control of the RF output level to simulate the RF burst signals used on Time Domain Duplex (TDD) and Time Domain Multiple Access (TDMA) systems.

A switchable input impedance of 50 or 300 Ω simplifies operation with 50 Ω voltage sources and interfacing with operational amplifiers or digital to analog converters.

Digital modulation

In addition to the wideband analog I and Q inputs a digital mode of operation is provided. This allows the user to generate a vector modulated RF carrier from digital data inputs. The bandwidth of the digital mode is sufficient to simulate radio systems which have been designed to work in the frequency allocation of an analog voice channel. The digital modulation can be set to symbol rates from 512 Hz to 34 kHz, and internal channel filters are applied with raised cosine, root raised cosine or gaussian characteristics.

Modulation formats can be defined as PSK, differential PSK, phase offset differential PSK, QAM, FSK, time offset QPSK and GMSK with from one to eight bits per symbol (i.e. up

to 256 QAM). The programmable channel filter and data rate ensures that many of the different types of narrow band digital modulation standards can be simulated by a single instrument.

The flexible digital interface gives the freedom to accept digital signals in bit or symbol format using an internal or external data clock. The digital interface can be set to use positive- or negative-edge triggering and normal or inverted data. An internal data source is also available which can supply a PRBS (Pseudo Random Bit Sequence), all '1's or all '0's. A burst control pin allows the generation of TDMA bursts with controlled rise and fall times.

The modulator can be requested to introduce IQ phase and gain errors and carrier leak to simulate the performance of a receiver operating on non-ideal waveforms.

Modulation formats

Specific modulation formats can be selected which provide the default data rates and channel filter settings for numerous predefined systems which include NADC (D-AMPS), PDC (JDC), TETRA, POCSAG, ERMES, TFTS and APCO 25 (QPSK). New user settings can be created and stored to define other modulation standards.

Envelope control

For both vector and digital modes the front panel ENVELOPE IN socket may be used to simulate the effect of varying the RF levels being received from mobiles in TDMA systems. It may also be used to shape the rise and fall of an RF burst. Additionally, in digital modulation mode, the burst control on the rear panel AUXILIARY IN/OUT socket allows RF bursts to be generated with profiled rise and fall times synchronised with the data inputs.

Fading simulation

The built-in Rician and Rayleigh fading simulator with programmable path ratio and Doppler speed allows the testing of receivers under the adverse propagation conditions, but note that this is not available for GSM.

Incrementing

All major parameters can be incremented or decremented in step sizes entered via keyboard entry or the GPIB. If no step size is entered for a parameter, the steps are preset to 1 kHz for carrier frequency, 1 kHz for modulation oscillator and LF frequency, 1 kHz for FM deviation, 1% for AM depth and 1 dB for output level.

In addition the rotary control can be used to vary the parameter with the sensitivity of the knob being changed by means of the $\times 10$ and $\div 10$ keys.

Sweep

The sweep capability of the 2050 Series allows comprehensive testing of systems. Four parameters are used to specify sweep; start, stop, number of steps and time per step. These are specified by the user, with upper and lower limits for the parameter values being dependent on the function. The sweep markers menu is available by soft key selection on the sweep display, allowing the placement of up to five user defined markers.

Non-volatile memory

The non-volatile memory allows 50 complete instrument settings, 50 partial settings, 100 carrier frequency settings, 20 sweep settings and 20 signalling tone sequences to be stored for later use at any time.

Programming

A GPIB interface is fitted so that all functions are controllable via the interface bus which is designed to the IEEE Standard 488.2. The instrument can function both as a talker and a listener.

Software protection

To prevent accidental interference with the contents of internal memories, internal data is protected by a secure key sequence.

Two levels of protection are offered, appropriate to the function being accessed. The most secure is reserved for features which alter the calibration data of the instrument.

Spectral purity

With an SSB phase noise performance at of typically -122 dBc/Hz at 470 MHz (20 kHz offset), the 2050 Series can be used for both in-channel and adjacent channel receiver measurements. Harmonically related signals and non-harmonics are better than -30 dBc and -70 dBc respectively.

Calibration

The 2050 Series has a recommended two year calibration interval and is calibrated entirely by electronically controlled adjustment. There are no internal mechanically adjustable components to affect the calibration. The calibration display is available via soft key selection at the utilities menu.

In both digital and vector modes a self calibration system optimises the performance of the vector modulator. The instrument displays a warning when the calibration validity has expired.

Date stamping

After readjustment the instrument updates the calibration data and records the date of adjustment. The calibration due date can be set and when this date is reached a message advises the operator to return the unit for calibration.

Options

The following factory-fitted options are available:

Option 001 - Second modulation oscillator

An additional modulation oscillator is available to enable greater flexibility. This second oscillator has the same specification as the first and allows full use of complex modulation modes.

Option 002 - Pulse modulation

The pulse modulation facility allows radar RF and IF stages to be tested and features rise and fall times of less than 25 ns with an on/off ratio of better than 70 dB.

Option 006 - Avionics

Provides internally generated modulation waveforms suitable for the testing of Instrument Landing Systems (ILS) and VHF Omni Range (VOR) beacons.

Option 008 - RF profiles and complex sweep

The RF profile facility provides compensation for frequency dependent level errors introduced by cables, amplifiers and signal combiners. The complex sweep facility generates sweeps whose step size, step time and RF level change while the sweep is in progress. These features are particularly useful for EMC, Tempest and ATE applications.

Option 012 - Electronic attenuator

Designed to meet demanding extended life requirements for repetitive switching, such as are found in high volume production applications.

Option 100 - Single fuse

A single fuse is used in place of the standard double fuse.

Option 105 - Modified pulse modulator

Modifies the pulse modulator (Option 002) to provide a slower rise and fall time for testing time domain duplex and time domain multiple access receivers.

Option 112 - EXT MOD 2 input 600 Ω

The EXT MOD 2 INPUT socket has a 600 Ω impedance in place of 100 k Ω .

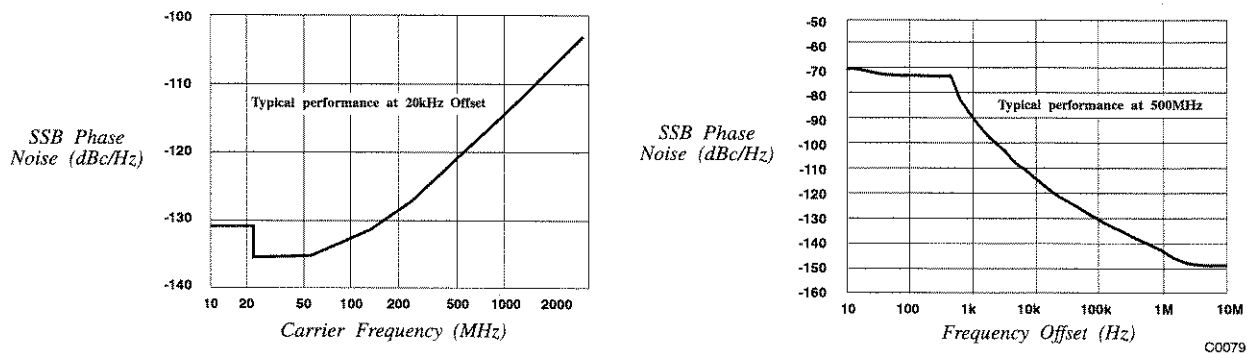

Fig. 1-1 Typical phase noise performance of 2050 Series in non-digital and -vector modes

PERFORMANCE DATA

CARRIER FREQUENCY

Range	10 kHz to 1.35 GHz (2050); 10 kHz to 2.7 GHz (2051); 10 kHz to 5.4 GHz (2052).
Selection	By keyboard entry of data. Variation by \uparrow/\downarrow keys and by rotary control.
Indication	11 digits with annunciators.
Resolution	0.1 Hz.
Accuracy	As frequency standard.
Phase incrementing	The carrier phase can be advanced or retarded in steps of $\pi/128$ radians using the rotary control.

RF OUTPUT

Range	<p>In analog modulation or CW mode range is -144 dBm to +13 dBm. Maximum guaranteed output level from 2.7 GHz to 5.4 GHz is +11 dBm.</p> <p>When AM is selected the maximum output level reduces linearly with AM depth to +7 dBm at maximum AM depth.</p> <p>Selectable overrange mode allows uncalibrated output levels to +19 dBm to be generated.</p> <p>Selectable extended hysteresis provides for uncalibrated RF level control with up to 24 dB range without level interruption.</p>
Selection	<p>By keyboard entry of data. Variation by \uparrow/\downarrow keys and by rotary control. Units may be μV, mV, V EMF or PD; dB relative to 1 μV, 1 mV EMF or PD; dBm.</p> <p>Conversion between dB and voltage units may be achieved by pressing the appropriate units key (dB, or V, mV, μV).</p>
Indication	4 digits with unit annunciators.
Resolution	0.1 dB.

Accuracy

At 23 ±5 °C in non-digital or -vector modes:

Output level	Carrier frequency range		
	10 kHz to 1.35 GHz	1.35 GHz to 2.7 GHz	2.7 GHz to 5.4 GHz
> -127 dBm	±0.85 dB	±1.0 dB	-
> -100 dBm	±0.85 dB	±1.0 dB	±1.5 dB
> -50 dBm	±0.85 dB	±1.0 dB	±1.5 dB
> =0 dBm	±0.50 dB	±0.7 dB	±1.0 dB
Temperature coefficient (dB/°C)	±0.005	±0.01	±0.02

In digital or vector modulation modes:

At a temperature of 23° ±5°C:

±1.5 dB at 23° ±5°C when IF auto selected (±1.75 dB absolute worst case).

Temperature coefficient is less than 0.04 dB/°C.

VSWR

For output levels less than 0 dBm:

Less than 1.25:1 to 2.2 GHz (return loss greater than 19.1 dB);

Less than 1.4:1 to 2.7 GHz (return loss greater than 15.6 dB);

Less than 1.5: 1 to 5.4 GHz (return loss greater than 14 dB).

Output protection

An electronic trip protects the generator output against reverse power of up to 50 W from a source VSWR of up to 5:1.

Output connector

50 Ω nominal, N-type female socket.

SPECTRAL PURITY

At RF levels up to +7 dBm in CW and analog modulation modes:-

Harmonics

2050, 2051:

Better than -30 dBc for carrier frequencies to 1 GHz;

Better than -27 dBc for carrier frequencies to 2.7 GHz.

2052:

Better than -25 dBc for carrier frequencies to 5.4 GHz.

Sub-harmonics

Better than -90 dBc to 1.35 GHz.

Better than -40 dBc to 2.3 GHz.

Better than -30 dBc to 5.4 GHz.

Non-harmonics

Better than -70 dBc at offsets from the carrier frequency of 3 kHz or greater.

Residual FM (FM off)

Less than 7 Hz RMS deviation in a 300 Hz to 3.4 kHz unweighted bandwidth at 470 MHz.

SSB phase noise	Less than -116 dBc/Hz (typically -122 dBc/Hz) at an offset of 20 kHz from a carrier frequency of 470 MHz.
RF leakage	Less than 0.5 μ V PD generated at the carrier frequency across a 50 Ω load by a two turn 25 mm loop, 25 mm or more from the case of the generator with the output terminated in a 50 Ω sealed load.
FM on AM	Typically less than 100 Hz for 30% AM depth at a modulation frequency of 1 kHz and a carrier frequency of 500 MHz.
Φ M on AM	Typically less than 0.1 radian at a carrier frequency of 500 MHz for 30% AM depth for modulation rates up to 10 kHz.
In digital and vector modes of operation:	Modulation is generated by converting a 120, 132, 160 or 176 MHz intermediate frequency (IF) to the required carrier frequency. Additional signals are present at the local oscillator frequency, image frequency and frequencies equivalent to the harmonics of the IF mixed with the local oscillator.
Phase noise:	In vector mode: As analog modulation and CW modes. In digital mode: As analog modulation modes of offsets >100 kHz; better than -108 dBc/Hz at 20 kHz offset from a 1 GHz carrier.

MODULATION MODES

	Six modulation modes are available:
Single	FM, Wideband FM, Φ M, AM or pulse (optional).
Dual	Two independent channels of differing modulation type (e.g. AM with FM).
Composite	Two independent channels of the same modulation type. (e.g. FM1 with FM2).
Dual composite	A combination of Dual and Composite modes providing four independent channels (e.g. AM1 with AM2 and FM1 with FM2).
Vector	Provides IQ modulation facility.
Digital	Accepts digital inputs and converts the signal to QAM, PSK, FSK or GMSK formats. Phase modulation can be used instead of FM (but not simultaneously).

FREQUENCY MODULATION

Deviation	Peak deviation from 0 to 1 MHz for carrier frequencies up to 21.09375 MHz; Peak deviation from 0 to 1% of carrier frequency above 21.09375 MHz.
Selection	By keyboard entry of data. Variation by \uparrow/\downarrow keys and by rotary control.

Indication	3 digits with annunciators.
Displayed resolution	1 Hz or 1 least significant digit, whichever is greater.
Accuracy at 1 kHz rate	$\pm 5\%$ of indication ± 10 Hz excluding residual FM.
1 dB bandwidth	DC to 300 kHz (DC coupled). 10 Hz to 300 kHz (AC coupled), typically 500 kHz.
3 dB bandwidth	Typically greater than 1 MHz. Input is capable of accepting external sources of FSK signals.
Group delay	Less than 1 μ s, 3 kHz to 500 kHz.
Carrier frequency offset	In DC FM less than $\pm(1 \text{ Hz} + 0.1\%$ of set deviation) after using DC FM nulling facility.
Distortion	Using external modulation without ALC: Less than 3% at maximum deviation for modulation frequencies up to 20 kHz; Less than 0.3% at 10% of maximum deviation for modulation frequencies up to 20 kHz.
Modulation source	Internal LF generator or external via front panel sockets.

WIDEBAND FM

A rear panel input on a BNC connector allows an external modulation signal to produce up to the maximum deviation. The deviation is controlled in 3 dB steps only and the generator will display the deviation equivalent to 1 V RMS sine wave input.

Deviation	As FM.
Indication	3 digits with annunciators.
Selection	By keyboard entry of data. A rear panel input on a BNC connector allows an external modulation signal to produce up to the maximum deviation. The deviation is controlled in 3 dB steps only and the generator will display the deviation equivalent to 1 V RMS sine wave input.
Input level	1.414 V peak (1 V RMS sine wave) to achieve indicated deviation.
Accuracy	As FM.
3 dB bandwidth	Typically 10 MHz (DC or AC coupled).
Group delay	Less than 0.5 μ s, 3 kHz to 10 MHz.
Modulation source	External via rear panel socket (50 Ω impedance).

PHASE MODULATION

Deviation	0 to 10 radians.
Selection	By keyboard entry of data. Variation by ↑/↓ keys and by rotary control.
Indication	3 digits with annunciators.
Resolution	0.01 radians.
Accuracy at 1 kHz	Better than $\pm 5\%$ of indicated deviation excluding residual phase modulation.
3 dB bandwidth	100 Hz to 10 kHz.
Distortion	Less than 3% at maximum deviation at 1 kHz modulation rate.
Modulation source	Internal LF generator or external via front panel sockets.

AMPLITUDE MODULATION

For carrier frequencies up to 1 GHz:

Range	0 to 99.9%.
Selection	By keyboard entry of data. Variation by ↑/↓ keys and by rotary control.
Resolution	0.1%
Indication	3 digits with annunciator.
Depth accuracy at 1 kHz	$\pm 4\%$ of setting $\pm 1\%$. Usable to 5.4 GHz.
External AM 1 dB bandwidth	With modulation ALC off; DC to 30 kHz in DC coupled mode and 10 Hz to 30 kHz in AC coupled mode. Typical modulation bandwidth exceeds 50 kHz.
Envelope distortion	For a modulation rate of 1 kHz: Less than 1% total harmonic distortion for AM depths up to 30%; Less than 3% total harmonic distortion for AM depths up to 80%.
Modulation source	Internal LF generator or external via front panel connectors.
External AM accuracy	With ALC off the modulation is calibrated for an input level of 1.0 V PD RMS sine wave.

VECTOR & DIGITAL MODULATION

In Digital or Vector modulation modes the following additional specifications apply:

Carrier frequency range	2050: 10 MHz to 1.35 GHz. 2051 and 2052: 10 MHz to 2.7 GHz.
-------------------------	--

RF output range	RF output level is defined with PRBS modulation applied in Digital mode or with 0.5 V DC applied to either the I or Q input in Vector mode. Maximum RF output level is +6 dBm peak envelope power. Minimum output level is -138 dBm.
Level accuracy	±1.5 dB for carrier frequencies to 2 GHz, ±2.0 dB for carrier frequencies to 2.7 GHz, at 23 ±5°C. Output power set is the average power with PRBS modulation applied.
Spectral purity	
Non-harmonics	Modulation is generated by converting a 120, 132, 160 or 176 MHz IF to the required carrier frequency. Additional signals are present at the local oscillator frequency, image frequency and frequencies equivalent to the harmonics of the IF mixed with harmonics of the local oscillator.
Phase noise	In Vector mode: as for normal analog modulation. In Digital mode : -108 dBc/Hz at 20 kHz offset from a 470 MHz carrier. As for normal analog modulation for offsets above 100 KHz.

DIGITAL MODULATION

In digital mode the instrument can be used to accept internal or external data to modulate the RF output. The modulation can be applied in common digital formats and the channel filter characteristics specified.

Internal data	All '0's, all '1's or PRBS sequence of length 2^n-1 where n may be selected from values 2 to 7, 9 to 11 or 15 (note that in GSM mode, n is limited to 9 or 15).
External data	Accepts data as a serial input or parallel input from a 25-way AUXILIARY D-type connector on the rear panel. Accepts symbols containing 1 to 8 data bits with internally or externally generated clock sources. In GSM mode, external data must be supplied as an 8-bit parallel data. All inputs and outputs are TTL/CMOS logic compatible.

Symbol rate

Modulation type	Filter type	Symbol rate (sym/s)
PSK / QAM	Nyquist / Root Nyquist	1900 - 34000
PSK / QAM	Gaussian	1900 - 25000
FSK / GMSK	Gaussian	512 - 25000
FSK	Nyquist / Root Nyquist	1900 - 25000
OQPSK	All filters	1900 - 16000

Symbol source can be internal or external (on rear panel connector).
Internal symbol rate can be programmed from 512 to 34000 symbol/s in 0.1 symbol/s steps.
External symbol rate must be within 2% of the entered symbol rate to maintain modulation accuracy.

Generic modulation types Can be selected from PSK, differential PSK, differential phase offset PSK, time-offset QPSK, QAM, GMSK, 2- or 4-level FSK. Number of bits per symbol can be selected from 1 to 3 for PSK systems and 1 to 8 for QAM systems.

RF channel filters Root raised cosine, raised cosine or gaussian. Filter bandwidth can be selected as follows: Raised cosine or root raised cosine for α from 0.2 to 0.8 in 0.01 steps.* Gaussian 3 dB bandwidth 0.4 of symbol rate (0.2 of symbol rate as IQ baseband filter) up to a maximum of 22.6 kHz. GMSK modes are produced with Gaussian filter only.

* Digital modulation accuracy may be degraded by up to 0.5% for α below 0.3 (root raised cosine) or 0.25 (raised cosine).

GMSK and FSK deviation range 100 Hz to 20 kHz, resolution 1 Hz.

Predefined modulation types The following predefined modulation types can be selected:

Modulation type	System
$\pi/4$ DQPSK	NADC (DAMPS), PDC (JDC), TETRA, APCO25, TFTS
GMSK	GSM, Mobitex, CDPM, MC9, DSRR, MD24-192, Modacom
FSK	POCSAG, CITYRUF
4FSK	ERMES, APCO25
OQPSK	Immarsat 'M'
D8PSK	VDR (VDL)

Modulation accuracy At the decision points with the envelope input at 1 V or disabled:
 <1.5% RMS for PSK systems.
 <1.5% RMS for QAM systems.
 GMSK and FSK, <1° of deviation.
 GSM and CDPD typically <3° RMS phase error.

Modulation errors Modulation errors can be added to simulate:
 IQ skew from 0 to $\pm 20^\circ$ in 0.1° steps,
 IQ imbalance from 0 to 10 dB in 0.1 dB steps,
 Carrier leak from 0 to 10% in 0.1% steps.
 Range of errors allowed is limited by the peak envelope power.
Note:

Modulation errors are not available in GSM or OQPSK modes.

IQ outputs Baseband IQ output signals available on the front panel at a level of 0.5 V PD nominal into 50 Ω .

Burst control Available on the rear panel D-type connector. Allows the RF level to be suppressed without linear control. Can be used at the same time as the ENVELOPE input. A logical '1' on the burst control turns the RF on. Includes an internal pull-up resistor to turn the RF on if it is not being used.

Delay	Same as for data.
ON/OFF ratio	Greater than 80 dB.
Rise/fall time	3 symbols.

VECTOR MODULATION

Provides for IQ modulation of the carrier output from an external source.

Vector inputs	IQ inputs are provided on the front panel. The RF level set is obtained with 0.5 V applied to one of the inputs. Input impedance is selectable between 50 Ω and 300 Ω .
DC vector accuracy	$\pm 1\%$ amplitude of full scale; $\pm 1^\circ$ at full scale For carrier frequencies above 2 GHz: $\pm 1.5\%$ amplitude of full scale $\pm 1.5^\circ$ at full scale above 2 GHz.
Vector bandwidth	± 0.5 dB wrt DC for modulation frequencies up to 3 MHz; ± 1 dB wrt DC (± 1.3 dB above 2 GHz) for frequencies up to 10 MHz.
Carrier suppression	Typically 50 dB at 10 kHz rate.
SSB image suppression	Typically 50 dB at 10 kHz rate, 50 dB at 1 MHz rate, 45 dB at 3 MHz rate and 40 dB at 10 MHz rate.

CALIBRATION

The signal generator can calibrate the vector modulator automatically. After a 0.5 hour warm up period the calibration remains valid for at least 3 hours over a temperature range of $\pm 5^\circ\text{C}$. The instrument displays a warning if the calibration validity time or temperature range has been exceeded. Calibration is valid for both digital and vector modes. Fading simulation is not available in either GSM or OQPSK modes.

FADING SIMULATION

Rayleigh and Rician fading can be simulated in both vector and digital modulation modes. Doppler speed can be entered from 0 to 200 Hz with a maximum ratio of 2:1 between the direct and scattered speed for Rician fading. Path ratio can be set to ± 50 dB.

Note:

Not available in either GSM or OQPSK modes.

ENVELOPE CONTROL

The RF level can be varied by applying a control voltage to the ENVELOPE input in digital and vector modes. The input may be used to shape the rise and fall of an RF burst and simulate the effect of varying RF levels being received from mobiles in TDMA systems.

Applying 1 V gives the set RF level and 0 V suppresses the carrier.

Linear range	Greater than 30 dB. Linearity typically better than ± 0.5 dB at -20 dB (100 mV input).
ON/OFF ratio	Greater than 80 dB.

Envelope delay	Less than 10 μ s, typically 6 μ s.
Rise/fall time	Less than 13 μ s to -70 dBc.
IF output	An IF output at nominally -10 dBm is available on the rear panel which is modulated by the selected digital or vector modulation. When set to external mixer, the IF output can be used to provide modulated carriers at higher frequencies by external frequency conversion. The RF output from the front panel connector can be set to carry no modulation so the RF signal can be used for external mixing.

MODULATION OSCILLATOR

Frequency range	0.1 Hz to 500 kHz (sine wave).
Selection	By keyboard entry of data. Variation by \uparrow/\downarrow keys and by rotary control.
Indication	7 digits with annunciators.
Resolution	0.1 Hz.
Frequency accuracy	As frequency standard.
Distortion	Less than 0.1% THD in sine wave mode at frequencies up to 20 kHz.
Alternative waveforms	A triangular wave is available for frequencies up to 100 kHz. A square wave is available for frequencies up to 2 kHz.
Signalling tones	The modulation oscillator can be used to generate sequential (up to 16 tones) or sub-audible signalling tones in accordance with EIA, ZVEI1, ZVEI2, DZVEI, CCIR, EURO1, EEA, NATEL and DTMF* standards. Facilities are also available for creating and storing user defined tone systems. *Requires second modulation oscillator (Option 001) to be fitted.

EXTERNAL MODULATION

Two independent inputs on the front panel with BNC connectors, EXT MOD 1 and EXT MOD 2. The modulation is calibrated with 1.414 V peak (1 V RMS sine wave applied). Input impedance 100 k Ω nominal (600 Ω at EXT MOD 2 with Option 112).

MODULATION ALC

The EXT MOD 1 and EXT MOD 2 modulation inputs can be levelled by an ALC system.

Level range	1 to 2 V peak (0.7 V to 1.4 V RMS sine wave).
Distortion	Less than 0.1% additional distortion for frequencies up to 20 kHz at 1 V RMS sine wave (typically less than 0.1% up to 50 kHz).
1 dB bandwidth	Typically 10 Hz to 500 kHz.

LF OUTPUT

Front panel BNC connector. The output may be configured in either LF Generator Mode to give an output from the internal modulation oscillator or in LF Monitor Mode to give an output from the internal modulation signal paths.

Selection	By keyboard entry of data. Variation by \uparrow/\downarrow keys and by rotary control.
Indication	7 digits with unit annunciators for frequency and 4 digits with unit annunciators for level.
Level	100 μV to 5 V RMS with a load impedance of greater than 600 Ω . 100 μV to 1.4 V RMS with a load impedance of greater than 50 Ω .
Source impedance	5.6 Ω nominal.
Level accuracy at 1 kHz	With a load impedance of greater than 10 k Ω :- $\pm 5\%$ for levels above 50 mV and $\pm 10\%$ for levels from 500 μV to 50 mV.
Frequency response	Typically better than ± 1 dB from 0.1 Hz to 300 kHz.

SWEEP

Control modes	Start/stop values of selected parameter; Number of steps; Time per step.
Step time	1 ms to 20 s per step.
Sweep ramp	Synchronized analog ramp with an amplitude of nominally 0 V to 10 V peak on rear panel BNC connector.
Markers	5 user selectable markers for frequency or level provide an indication when specified parameter values have been reached. Output 0 V to +5 V nominal from 600 Ω on rear panel BNC socket.
Trigger	Rear panel BNC connector. Applying 0 V or a switch closure starts the sweep or steps the sweep from point to point. Connector is internally connected via 10 k Ω pull-up resistor to +5 V.

IF OUTPUT

An IF output is available on the rear panel which with external mixer selected is modulated by the selected digital or vector modulation. The IF output can be inhibited by software control. The IF output can be used to provide modulated carriers at higher frequencies by external frequency conversion. The RF output from the front panel connector can be used as an LO for external frequency conversion.

FREQUENCY STANDARD

Frequency	10 MHz.
Temperature stability	Better than ± 5 in 10^8 over the operating range of 0 to 50°C.
Warm-up time	Within 2 in 10^7 of final frequency within 10 minutes from switch on at 20°C ambient.
Aging rate	Better than 2 in 10^7 per year; better than 5 in 10^{10} per day after 1 month continuous use.
Output	Rear panel BNC socket provides an output at frequencies of 1, 5 or 10 MHz with a nominal 2 V pk-pk level into 50 Ω .
External input	Rear panel BNC socket accepts an input of 220 mV to 1.8 V RMS into 1 k Ω at a frequency of 1, 5 or 10 MHz.

GPIB INTERFACE

	A GPIB interface is fitted. All functions except the supply switch are remotely programmable.
Capabilities	Complies with the following subsets as defined in IEEE Std. 488.1. SH1, AH1, T6, TE0, L4, LE0, SR1, RL1, PP0, DC1, DT1, C0, E2.

ELECTRO-MAGNETIC COMPATIBILITY

Conforms with the protection requirements of EEC Council Directive 89/336/EEC.
Complies with the limits specified in the following standards: EN55011 Class B, EN 50082-1, EN 60555-2, CISPR 11, IEC 61000-4-2, 3, 4, IEC 60555-2, AS/NZS 2064.1/2, AS/NZS 4252.1.

SAFETY

Complies with IEC 348.
UL 1244 approved.

RATED RANGE OF USE (Over which full specification is met).

Temperature	0 to 55°C.
Humidity	Up to 93% at 40°C.

CONDITIONS OF STORAGE AND TRANSPORT

Temperature	-40°C to +71°C.
Humidity	Up to 93% relative humidity at 40°C.
Altitude	Up to 4600 m (15,000 ft).

POWER REQUIREMENTS

AC supply	Four settings covering 90-115 V, 105-132 V, 188-242 V and 216-265 V. 45 Hz to 400 Hz. 120 to 180 VA maximum depending on version and options fitted.
-----------	--

CALIBRATION INTERVAL

2 years.

DIMENSIONS AND WEIGHT

(Over projections but excluding front panel handles):

Height	Width	Depth	Weight
152 mm 6.0 in	425 mm 16.6 in	525 mm 20.5 in	21 kg 46 lb

SECOND MODULATION OSCILLATOR OPTION

Specification as Modulation Oscillator.

EXT MOD 2 INPUT 600 Ω OPTION

The EXT MOD 2 INPUT socket has a 600 Ω input impedance in place of 100 k Ω .

PULSE MODULATION (OPTIONS 002 and 105)

Modulation modes	Pulse modulation may be used alone or in conjunction with FM, Φ M, Wideband FM, Vector or Digital modulation.
Switching speed	Rise and fall times less than 25 ns from 10% to 90%. Typically 1 μ s with Option 105 (DECT).
Control	0 to +1 V for carrier off, +3.5 to +5 V for carrier on.
Maximum input level	+5.0 V.
ON/OFF ratio	Better than 70 dB at the carrier frequency, typically exceeds 80 dB.
Additional level error	Less than ± 0.5 dB when modulation enabled.
Propagation delay	Typically 80 ns from PULSE INPUT to RF OUTPUT. Typically 3.5 μ s with Option 105 (DECT).
Input impedance	50 Ω nominal.

ELECTRONIC ATTENUATOR OPTION

Carrier frequency range	250 kHz* to 1.35 GHz (2050), 250 kHz* to 2.7 GHz (2051). *Usable to 10 kHz.
RF output range	-138 dBm to +10 dBm. When AM is selected the maximum output level reduces linearly with AM depth to +4 dBm at maximum AM depth.
Accuracy	± 1.2 dB for output levels > -127 dBm at 22°C $\pm 5^\circ$ C.
Temperature stability	± 0.01 dB/ $^\circ$ C.
VSWR	$< 1.5:1$ for output levels less than 0 dBm.
Reverse power handling	1 W from a source VSWR of up to 5:1.
Amplitude modulation	Standard specification applies for carrier frequencies above 50 MHz.

AVIONICS OPTION

See Annex A.

RF PROFILES AND COMPLEX SWEEP OPTION

See Annex B.

VERSIONS, OPTIONS AND ACCESSORIES

When ordering please quote the full ordering number information.

Ordering numbers

2050
2051
2052

Versions

10 kHz to 1.35 GHz Digital and Vector Signal Generator.
10 kHz to 2.7 GHz Digital and Vector Signal Generator.
10 kHz to 5.4 GHz Digital and Vector Signal Generator.

Options

Options are factory fitted only and must be specified at the time of ordering.

Option 001
Option 002
Option 006
Option 008
Option 012
Option 105
Option 112

Second internal modulation oscillator.
External pulse modulation.
Avionics.
RF profiles and complex sweep.
Electronic attenuator.
Modified pulse modulator (DECT).
EXT MOD 2 input 600 Ω .

Supplied accessories

46882-237W

AC supply lead (see 'Power cords', Chap.2).
Operating manual (this manual) for 2050 series.

Optional accessories

46880-062W
43126-012S
54311-092P
59999-163K
54411-051X
54311-095C
43129-189U
46883-408K
46884-291A

46884-292Z

46884-541Y
46884-444G
46662-525Y
54112-164D
54499-044F
44991-144B

Service manual for 2050 series.
RF connector cable, TM 4969/3, 50 Ω , 1.5 m, BNC.
Coaxial adapter N-type male to BNC female.
Precision coaxial adapter, N-type male to SMA female.
Impedance adapter, 50 to 75 Ω , BNC connectors.
RF connector cable, 1 m, N-type connectors.
GPIB lead assembly.
IEEE/IEC adapter block for GPIB socket.
Rack mounting kit (with slides) for rack cabinets with depths from 480 mm to 680 mm.
Rack mounting kit (with slides) for rack cabinets with depths from 680 mm to 840 mm.
Rack mounting kit containing front mounting brackets only.
Maintenance kit for 2050 series.
Transit case (aluminium).
Soft carrying case.
DECT filter.
Breakout box. Converts AUXILIARY IN/OUT connector to 8 data and 1 burst line and 2 clock lines on BNC connectors. Daisy chain connection allows the monitoring of the signals (on BNC connectors).

EC Declaration of Conformity

Certificate Ref. No.

EEA00006

The undersigned, representing:

Manufacturer:	IFR Ltd.
Address:	Longacres House, Norton Green Road, Stevenage, Hertfordshire, U. K. SG1 2BA

Herewith declares that the product:

Equipment Description:	Digital and Vector Signal Generators
Model No.	2050, 2051 and 2052
Options:	1, 2, 4, 6, 8, 12, 100, 101, 102, 105, 108 and 112

is in conformity with the following EC directive(s)
(including all applicable amendments)

Reference No.	Title:
73/23/EEC	Low Voltage Directive
89/336/EEC	EMC Directive

and that the standards and/or technical specifications referenced below have been applied:

Safety:	EMC:	
HD401 (IEC348:1978)	EN55011:1991 Class B	
	EN50082-1:1992	
	EN60555-2:1987	

IFR Stevenage _____ (Place)

15th June 1998 _____ (Date)

Alan Smithies _____ (Signature)

Alan Smithies - Product Liability Manager



Chapter 2

INSTALLATION

CONTENTS

	PAGE
INITIAL VISUAL INSPECTION.....	2-2
MOUNTING ARRANGEMENTS.....	2-2
INSTALLATION REQUIREMENTS	2-2
Ventilation	2-2
Class I power cords (3-core).....	2-2
GOODS-IN CHECKS	2-5
CONNECTING TO SUPPLY	2-5
Voltage selector	2-5
Fuses	2-5
GENERAL PURPOSE INTERFACE BUS (GPIB).....	2-6
GPIB cable connection	2-6
GPIB connector contact assignments	2-6
IEEE to IEC conversion.....	2-7
Interface bus connection.....	2-7
AUXILIARY I/O CONNECTOR	2-7
Modulation data	2-8
Power supply outputs.....	2-8
Auxiliary outputs	2-8
RACK MOUNTING	2-9
ROUTINE MAINTENANCE.....	2-9
Safety testing and inspection	2-9
BATTERY REPLACEMENT	2-11
CLEANING	2-11
Cleaning the LCD window	2-11
PUTTING INTO STORAGE	2-11

LIST OF TABLES

Table 2-1 Modulation data contact assignments.....	2-8
--	-----

LIST OF FIGURES

Fig. 2-1 AC connector showing voltage selector and fuse holders	2-6
Fig. 2-2 GPIB connector contact assignments (viewed from rear of instrument).....	2-6
Fig. 2-3 IEEE to IEC conversion.....	2-7
Fig. 2-4 25-way AUXILIARY I/O connector	2-7

WARNING - INITIAL VISUAL INSPECTION

After unpacking the instrument, inspect the shipping container and its cushioning material for signs of stress or damage. If damage is identified, retain the packing material for examination by the carrier in the event that a claim is made. Examine the instrument for signs of damage; do not connect the instrument to a supply when damage is present, internal electrical damage could result in shock if the instrument is turned on.

MOUNTING ARRANGEMENTS

Excessive temperatures may affect the performance of the instrument. Completely remove the plastic cover, if one is supplied over the case, and avoid standing the instrument on or close to other equipment which is hot.

CAUTION - INSTALLATION REQUIREMENTS

Ventilation

This instrument is forced air cooled by a fan mounted on the rear panel. Air must be allowed to circulate freely through the ventilator grills located on the side and underside of the instrument. Before switching on the instrument, ensure that the air outlet on the rear panel is not restricted (i.e. clearance of at least 75 mm at the rear, 25 mm at each side, 15 mm on the underside). Failure to provide adequate clearances will increase internal temperatures and reduce the instrument reliability, so its performance may not meet specification.

Class I power cords (3-core)

General

When the equipment has to be plugged into a Class II (ungrounded) 2-terminal socket outlet, the cable should either be fitted with a 3-pin Class I plug and used in conjunction with an adapter incorporating a ground wire, or be fitted with a Class II plug with an integral ground wire. The ground wire must be securely fastened to ground. Grounding one terminal on a 2-terminal socket will not provide adequate protection.

In the event that a moulded plug has to be removed from a lead, it must be disposed of immediately. A plug with bare flexible cords is hazardous if engaged in a live socket outlet.

Power cords with the following terminations are available from IFR Ltd. Please check with your local sales office for availability.

This equipment is provided with a 3-wire (grounded) cordset which includes a moulded IEC 320 connector for connection to the equipment. The cable must be fitted with an approved plug which, when plugged into an appropriate 3-terminal socket outlet, grounds the case of the equipment. Failure to ground the equipment may expose the operator to hazardous voltage levels. Depending upon the destination country, the colour coding of the wires will differ:-

Wire ended

Country	IEC 320 plug type	IFR part number
Universal	Straight through	23424-158
Universal	Right angled	23424-159

	North America	Harmonised
Line (Live)	Black	Brown
Neutral	White	Blue
Ground (Earth)	Green	Green/Yellow

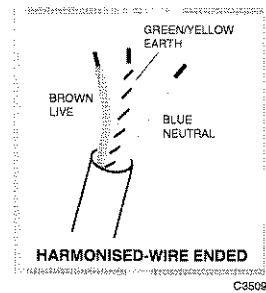

British

Country	IEC 320 plug type	IFR part number
United Kingdom	Straight through	23422-001
United Kingdom	Right angled	23422-002

The UK lead is fitted with an ASTA approved moulded plug to BS 1363.

A replaceable 13 A fuse to BS 1362 is contained within the plug. This fuse is only designed to protect the lead assembly. Never use the plug with the detachable fuse cover omitted or if the cover is damaged.

The fuse(s) or circuit breaker to protect the equipment is fitted at the back of the equipment.

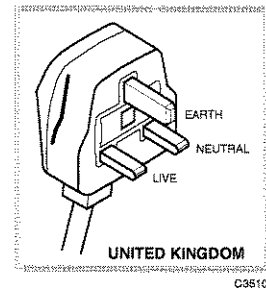

North American

Country	IEC 320 plug type	IFR part number
North American	Straight through	23422-004
North American	Right angled	23422-005

The North American lead is fitted with a NEMA 5-15P (Canadian CS22.2 No 42) plug and carries approvals from UL and CSA for use in the USA and Canada.

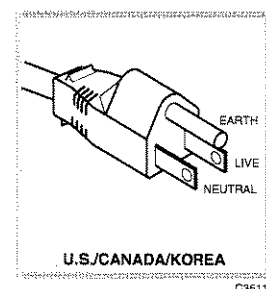

Continental Europe

Country	IEC 320 plug type	IFR part number
Europe	Straight through	23422-006
Europe	Right angled	23422-007

The Continental European lead is fitted with a right angle IEC83 standard C4 plug (CEE 7/7) which allows it to be used in sockets with either a male earth pin (standard C 3b) or side earth clips (standard C 2b) the latter is commonly called the German 'Schuko' plug. In common with other Schuko style plugs, the plug is not polarized when fitted into a Schuko socket. The lead carries approvals for use in Austria, Belgium, Finland, France, Germany, Holland, Italy, Norway and Sweden. Note that this plug will not fit Italian standard CEI 23-16 outlets. The lead should not be used in Denmark given that the earth connection will not be made.

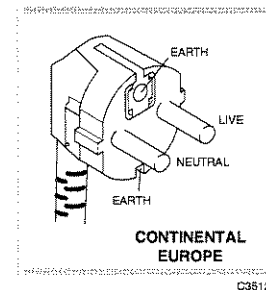

Français

Le câble d'alimentation d'Europe Continentale est muni d'un connecteur mâle à angle droit type CEI83, standard C4 (CEE 7/7), qui peut être utilisé dans une prise femelle à ergot de terre (standard C 3b) ou à clips latéraux (standard C 2b), cette dernière étant communément appelée prise "Schuko" allemande. De la même façon que les autres connecteurs de type Schuko, celui-ci n'est pas polarisé lorsqu'il s'adapte à une prise femelle Schuko. Ce câble d'alimentation est homologué en Allemagne, Autriche, Belgique, Finlande, France, Hollande, Italie, Norvège et Suède. A noter que ce connecteur n'est pas compatible avec les prises de courant italiennes au standard CEI 23-16. Ce câble ne doit pas être utilisé au Danemark à cause du défaut de connexion de masse.

Deutsch

Das kontinentaleuropäische Netzkabel ist mit einem rechtwinkligen Stecker nach IEC83 C4 (CEE7/7) Standard versehen, welcher sowohl in Steckdosen mit Erde-Stift (Standard C 3b) oder seitlichen Erdeklemmen, im allgemeinen "Schukosteckdose" genannt, paßt. Üblicherweise ist der Schukostecker bei Verwendung in Schukosteckdosen nicht gepolt. Dieses Netzkabel besitzt Zulassung für Österreich, Belgien, Finnland, Frankreich, Deutschland, Holland, Italien, Norwegen und Schweden.

Hinweis: Dieser Schukostecker paßt nicht in die italienischen Standardsteckdosen nach CEI 23-16 Norm. Dieses Netzkabel sollte nicht in Dänemark verwendet werden, da hier keine Erdeverbindung hergestellt wird.

Español

El cable de alimentación tipo Europeo Continental dispone de una clavija C4 normalizada IEC83 (CEE 7/7) que permite su utilización tanto en bases de enchufe con toma de tierra macho (tipo C 3b) o con toma de tierra mediante contactos laterales (tipo C 2b) que, en este último caso, suele denominarse "Schuko". Al igual que cualquier otra clavija tipo Schuko, las conexiones a red no están polarizadas cuando se conectan a una base tipo Schuko. El cable lleva autorización para su uso en Austria, Bélgica, Finlandia, Francia, Alemania, Holanda, Italia, Noruega y Suecia. Observe que este cable no se adapta a la norma italiana CEI 23-16. El cable no debe utilizarse en Dinamarca en el caso de no efectuarse conexión a tierra.

Italiano

I cavi d'alimentazione per l'Europa continentale vengono forniti terminati con una spina ad angolo retto del tipo C4 secondo lo standard IEC83 (CEE 7/7) che può essere usato in prese in cui la terra può essere fornita o tramite connettore maschio (C 3b) o tramite clips laterali (C 2b), quest'ultima comunemente detta di tipo tedesca "Schuko". Questa spina, quando collegata ad una presa Schuko, non è polarizzata.

Il cavo può essere usato in Austria, Belgio, Finlandia, Francia, Germania, Olanda, Norvegia, Svezia ed Italia. E' da notare che per l'Italia questo non risponde allo standard CEI 23-16.

Questa spina non dovrebbe invece essere usata in Danimarca in quanto non realizza il collegamento di terra.

GOODS-IN CHECKS

The following goods-in checks verify that the instrument is functioning correctly, but does not verify conformance to the listed specification. To verify that the instrument conforms to the specification given in Chapter 1, refer to Chapter 6, 'Acceptance testing',

- (1) Ensure that the correct fuse is fitted (accessible from the rear panel) and connect the instrument to the supply.
- (2) Switch on and check that a display is present.
- (3) If the instrument appears to be completely dead, carry out the following:

Check that the mains power supply line is providing power to the instrument.

Check that the mains fuses have not blown.

CONNECTING TO SUPPLY

Before connecting the instrument to the AC supply, check the setting of the voltage selector switch which is an integral part of the supply connector at the rear of the instrument.

Voltage selector

The selected voltage is displayed in a window at the top of the connector. The instrument is normally despatched with the selector set to 240 V. To select another voltage, insert a screwdriver into the slot at the top of the moulding and twist slightly so that the cover is free to hinge downwards. Rotate the barrel so that the correct setting is displayed, see Fig. 2-1.

Setting	Voltage range
100 V	90 - 115 V
120 V	105 - 132 V
220 V	188 - 242 V
240 V	216 - 265 V

Fuses

The correct fuse rating for each voltage setting is as follows:

100 V to 120 V, 1.6 A-TT (1.6 amp double time lag)

220 V to 240 V, 1 A-TT (1 amp double time lag)

Fuses are cartridge type measuring 20 mm x 5 mm.

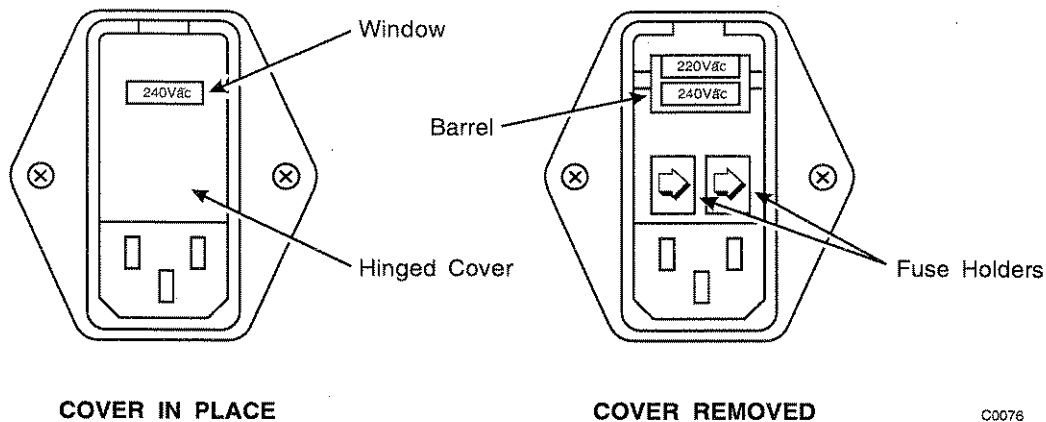

Fig. 2-1 AC connector showing voltage selector and fuse holders

GENERAL PURPOSE INTERFACE BUS (GPIB)

The GPIB interface built into the 2050 series enables the signal generators to be remotely controlled to form part of an automatic measuring system.

GPIB cable connection

Connection to other equipment which has a 24-way connector to IEEE Standard 488 is made using the rear panel GPIB socket. For this purpose, the GPIB cable assembly, available as an optional accessory, (see Chap. 1 'Accessories') may be used.

GPIB connector contact assignments

The contact assignments of the GPIB cable connector and the device connector are as shown in Fig. 2-2.

Contact	Function	Contact	Function
1	Data I/O 1	13	Data I/O 5
2	Data I/O 2	14	Data I/O 6
3	Data I/O 3	15	Data I/O 7
4	Data I/O 4	16	Data I/O 8
5	EOI	17	REN
6	DAV	18	Pair with 6
7	NRFD	19	Pair with 7
8	NDAC	20	Pair with 8
9	IFC	21	Pair with 9
10	SRQ	22	Pair with 10
11	ATN	23	Pair with 11
12	Ground shield	24	Logic ground

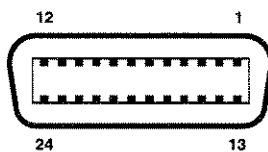

Fig. 2-2 GPIB connector contact assignments (viewed from rear of instrument)

IEEE to IEC conversion

An optional IEEE to IEC adapter is also available (see Chap. 1 'Optional Accessories') for interfacing with systems using a 25-way bus connector to IEC Recommendation 625. The method of use is shown in Fig. 2-3.

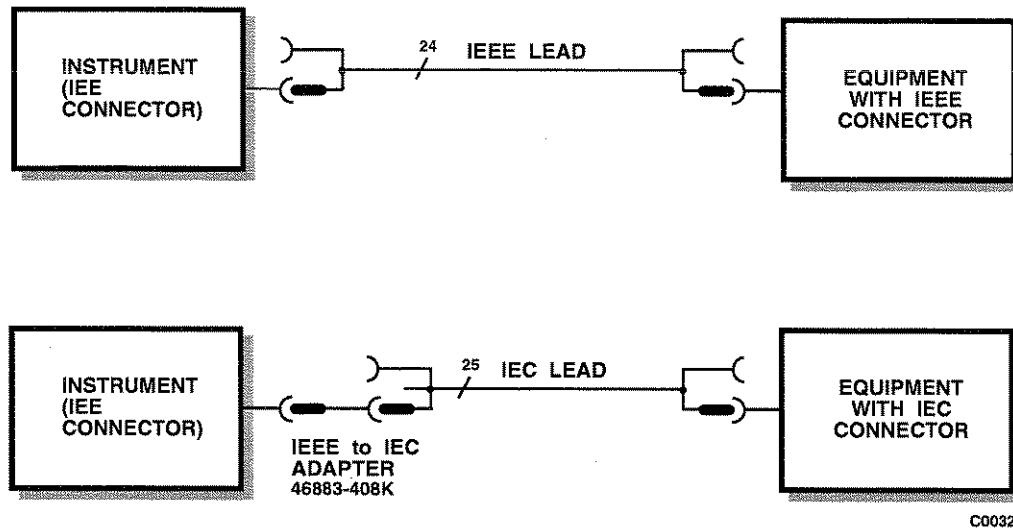

Fig. 2-3 IEEE to IEC conversion

Interface bus connection

The cables for the interface bus use special male-female connectors at both ends. This allows several connectors to be stacked one on top of another permitting several cables to be connected to the same source and secured by a lockscrew mechanism. Too large a stack, however, may form a cantilevered structure which might cause damage and should be avoided. The piggyback arrangement permits star or linear interconnection between the devices with the restriction that the total cable length for the system must be:-

- (1) No greater than 20 m (65 ft).
- (2) No greater than 2 m (6 ft) times the total number of devices (including the controller) connected to the bus.

AUXILIARY I/O CONNECTOR

The rear panel 25-way female D-type AUXILIARY I/O connector is shown in Fig. 2-4. This carries modulation data inputs and power supply outputs as well as having contacts used for external control.

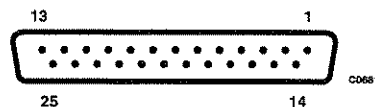

Fig. 2-4 25-way AUXILIARY I/O connector

Modulation data

Data for the modulator and burst control are carried on the contacts for the various formats as shown by Table 2-1.

TABLE 2-1 MODULATION DATA CONTACT ASSIGNMENTS

DATA FORMAT	CONTACT								
	11	14	15	16	17	18	19	20	21
Serial	Burst control	X	X	X	X	X	X	X	Data
2-bit parallel	Burst control	X	X	X	X	X	X	D0	D1
3-bit parallel	Burst control	X	X	X	X	X	D0	D1	D2
4-bit parallel	Burst control	X	X	X	X	D0	D1	D2	D3
5-bit parallel	Burst control	X	X	X	D0	D1	D2	D3	D4
6-bit parallel	Burst control	X	X	D0	D1	D2	D3	D4	D5
7-bit parallel	Burst control	X	D0	D1	D2	D3	D4	D5	D6
8-bit parallel	Burst control	D0	D1	D2	D3	D4	D5	D6	D7

where X = don't care and D0 is the least significant bit

Note that in parallel data modes the data is shifted from parallel to serial internally hence contact 21 is always the most significant data bit.

The strobes for the above data have selectable polarity and direction. For loading parallel data the symbol clock is used. For loading serial data both the symbol and bit clocks are used.

SYMBOL CLOCK I/O	contact 10
DETECTION	contact 22 - DO NOT USE
BIT CLOCK I/O	contact 23
BIT CLOCK OUTPUT	contact 24

All data and clock signals are TTL/CMOS compatible.

Power supply outputs

The following power supply outputs are available for driving external interfaces:

GROUND	contact 12
+22 V, 300 mA max	contact 13
-12 V, 300 mA max	contact 25

Auxiliary outputs

The following outputs can be used for controlling external devices:

AUX 0	contact 1
AUX 1	contact 2
AUX 2	contact 3
AUX 3	contact 4
AUX 4	contact 5
AUX 5	contact 6
AUX 6	contact 7
AUX 7	contact 8
AUX ENABLE	contact 9

Each output is CMOS compatible. The aux enable input needs to be set to a logical high to enable the outputs.

RACK MOUNTING

The instrument, which is normally supplied for bench mounting, may be mounted in a standard 19 inch rack (see Chap. 1 'Optional Accessories'). There are two slide rack mounting kits to accommodate different depths of cabinet. These kits include full fitting instructions. A rack mounting kit without slides is also available which contains front panel mounting brackets only.

CAUTION - ROUTINE MAINTENANCE

Safety testing and inspection

In the UK, the 'Electricity at Work Regulations' (1989) section 4(2) places a requirement on the users of equipment to maintain it in a safe condition. The explanatory notes call for regular inspections and tests together with a need to keep records.

The following electrical tests and inspection information is provided for guidance purposes and involves the use of voltages and currents that can cause injury. It is important that these tests are only performed by competent personnel.

Prior to carrying out any inspection and tests, the instruments must be disconnected from the mains supply and all external signal connections removed. All tests should include the instrument's own supply lead, all covers must be fitted and the equipment supply switch must be in the 'ON' position.

The recommended inspection and tests fall into three categories and should be carried out in the following sequence:-

1. Visual inspection
2. Earth bonding tests
3. Insulation resistance test

1. Visual inspection

A visual inspection should be carried out on a periodic basis. This interval is dependent on the operating environment, maintenance and use, and should be assessed in accordance with guidelines issued by the Health and Safety Executive (HSE). As a guide, this instrument when used indoors in a relatively clean environment would be classified as 'low risk' equipment and hence should be subject to safety inspections on an annual basis. If the use of the equipment is contrary to the conditions specified, you should review the safety re-test interval.

As a guide, the visual inspection should include the following where appropriate:

Check that the equipment has been installed in accordance with the instructions provided (e.g. that ventilation is adequate, supply isolators are accessible, supply wiring is adequate and properly routed).

The condition of the mains supply lead and supply connector(s).

Check that the mains supply switch isolates the instrument from the supply.

The correct rating and type of supply fuses.

Security and condition of covers and handles.

Check the supply indicator functions (if fitted).

Check the presence and condition of all warning labels and markings and supplied safety information.

Check the wiring in re-wireable plugs and appliance connectors.

If any defect is noted this should be rectified before proceeding with the following electrical tests.

2. Earth bonding tests

Earth bonding tests should be carried out using a 25 A (12 V maximum open circuit voltage) DC source. Tests should be limited to a maximum duration of 5 seconds and have a pass limit of 0.1Ω after allowing for the resistance of the supply lead. Exceeding the test duration can cause damage to the equipment. The tests should be carried out between the supply earth and exposed case metalwork, no attempt should be made to perform the tests on functional earths (e.g. signal carrying connector shells or screen connections) as this will result in damage to the equipment.

3. Insulation resistance test

A 500 V DC test should be applied between the protective earth connection and combined live and neutral supply connections with the equipment supply switch in the 'ON' position. It is advisable to make the live/neutral link on the appliance tester or its connector to avoid the possibility of returning the instrument to the user with the live and neutral poles linked with an ad-hoc strap. The test voltage should be applied for 5 seconds before taking the measurement. IFR products employ reinforced insulation in their construction and hence a minimum pass limit of $7 \text{ M}\Omega$ should be achieved during this test.

Where a DC power adapter is provided with the instrument, the adapter must pass the $7 \text{ M}\Omega$ test limit.

We do not recommend dielectric flash testing during routine safety tests. Most portable appliance testers use AC for the dielectric strength test which can cause damage to the supply input filter capacitors.

4. Rectification

It is recommended that the results of the above tests are recorded and checked during each repeat test. Significant differences between the previous readings and the measured values should be investigated.

If any failure is detected during the above visual inspection or tests, the instrument should be disabled and the fault should be rectified by an experienced Service Engineer who is familiar with the hazards involved in carrying out such repairs.

Safety critical components should only be replaced with equivalent parts, using techniques and procedures recommended by IFR Ltd.

The above information is provided for guidance only. IFR products are designed and constructed in accordance with International Safety Standards such that in normal use they represent no hazard to the operator. IFR Ltd reserves the right to amend the above information in the course of continuing its commitment to product safety.

BATTERY REPLACEMENT

The instrument contains a realtime clock which is powered by a lithium battery when the normal power is removed. Although battery life can extend to five years, this will depend on conditions of use, e.g. battery life is reduced as the temperature is increased. To avoid loss of data it is recommended that the battery is replaced every two years.

Replace the battery as follows:

- (1) Ensure that the instrument is switched on; this will provide power for the non-volatile memory while the battery is replaced. If this is not possible, the clock will continue to run for approximately 30 seconds, whilst the replacement is made.
- (2) Using a coin or suitable tool, unscrew the battery compartment cover at the rear of the instrument.
- (3) Remove the battery, noting its orientation. Insert the replacement, then replace the battery compartment cover.

The replacement battery should be SAFT L56 or equivalent. This is a lithium 3.5 V type, rated at 1800 mA_H, size AA. If a lithium battery is unobtainable an alkaline battery can be used but it will have a shorter life. A suitable battery can be obtained from IFR (part number 23711-106Z).

CLEANING

Before commencing any cleaning, switch off the instrument and disconnect it from the supply. The exterior surface of the case may be cleaned using a soft cloth moistened in water. Do not use aerosol or liquid solvent cleaners.

Cleaning the LCD window

To prevent damage to the LCD window, care should be taken not to scratch the surface during use and also when cleaning. The LCD window should be cleaned by wiping a slightly damp, soft, lint-free cloth gently over the surface.

PUTTING INTO STORAGE

If the instrument is to be put into storage, ensure that the following conditions are maintained:

Temperature range: -40 to 70°C
Humidity: Less than 93% at 40°C



Chapter 3-1 OPERATION

CONTENTS

	PAGE
OPERATION	3-1-1
INTRODUCTION	3-1-6
CONVENTIONS	3-1-6
FRONT PANEL	3-1-6
REAR PANEL	3-1-8
THE MENUS	3-1-9
FIRST TIME USE	3-1-11
Switching on	3-1-11
Changing the value of the selected parameter	3-1-11
Enabling or disabling the modulation	3-1-12
Using the [↑ ×10] and [↓ ÷10] keys	3-1-12
Using the control knob	3-1-12
DETAILED OPERATION	3-1-13
CARRIER FREQUENCY	3-1-13
Carrier ON/OFF	3-1-13
OUTPUT LEVEL	3-1-13
Choice of units	3-1-13
Reverse power protection	3-1-13
MODULATION	3-1-14
Complex modulation modes	3-1-14
Analog modulation modes	3-1-14
Modulation mode selection	3-1-15
DIGITAL MODULATION MODE	3-1-17
DIGITAL MODULATION	3-1-17
Setting the output carrier	3-1-17
Self-calibration	3-1-17
Setting the digital modulation system	3-1-18
Modulation type and system selection	3-1-18
Storing a user-defined system	3-1-20
Cellular systems selection	3-1-21
Paging systems selection	3-1-21
PMR systems selection	3-1-23
Avionic/Satellite systems selection	3-1-24
Cordless systems selection	3-1-25
Creating a modulation system	3-1-25
Selecting the modulation type	3-1-26
Symbol rate setting	3-1-28
Filter selection	3-1-29
Parameter constraints	3-1-30
TEST TONES UTILITY	3-1-31
Test tones operation	3-1-31
DATA/TIMING	3-1-32
Data	3-1-32
Timing	3-1-32
Selecting internal data	3-1-33
DIGITAL DATA MAPPING	3-1-34
PSK	3-1-34
BPSK (2PSK)	3-1-34

8PSK	3-1-35
Time offset QPSK.....	3-1-35
Phase offset differential PSK.....	3-1-36
QAM.....	3-1-38
FSK	3-1-40
2FSK	3-1-40
MODULATION CONFIGURATION	3-1-41
IQ output enable.....	3-1-41
Mixer selection	3-1-42
Pulse input selection (applies if Option 002 fitted)	3-1-42
Sideband and IF selection.....	3-1-42
Modulation polarity.....	3-1-43
External envelope.....	3-1-43
MODULATION FADING	3-1-43
IQ MODULATOR ERRORS	3-1-44
VECTOR MODULATION MODE.....	3-1-47
VECTOR MODULATION.....	3-1-47
Setting the output carrier	3-1-47
Self-calibration	3-1-47
MODULATION CONFIGURATION	3-1-48
Mixer selection	3-1-49
IQ input impedance selection	3-1-49
Pulse input selection (applies if Option 002 fitted)	3-1-50
Sideband and IF selection.....	3-1-50
Modulation polarity.....	3-1-50
External envelope.....	3-1-50
MODULATION FADING	3-1-51
ANALOG MODULATION MODE.....	3-1-53
ANALOG MODULATION.....	3-1-53
Selecting the modulation.....	3-1-53
Modulation ON/OFF.....	3-1-53
Selecting amplitude modulation	3-1-54
Selecting frequency modulation	3-1-54
Selecting phase modulation.....	3-1-54
Selecting wideband frequency modulation	3-1-54
Modulation source frequency	3-1-55
Source selection - internal	3-1-55
Source selection - external	3-1-57
MODULATION ALC	3-1-57
PULSE MODULATION	3-1-58
Selecting the pulse modulation mode	3-1-58
Selecting pulse modulation.....	3-1-58
Low intermodulation mode	3-1-59
SIGNALLING.....	3-1-60
CTCSS.....	3-1-60
Sequential calling tones.....	3-1-61
INCREMENTING (using Δ)	3-1-66
Displaying shifts	3-1-66
Setting increment values	3-1-66
SWEEP	3-1-67
Sweep type.....	3-1-67
Sweep mode.....	3-1-68
Sweep parameter entry	3-1-69
Sweep control	3-1-70
UTILITIES.....	3-1-73
Adjusting the display.....	3-1-73

Hardware information	3-1-74
Software information.....	3-1-74
External trigger	3-1-74
Setting the modulation mode	3-1-75
Setting the GPIB address.....	3-1-75
Sequential calling tones.....	3-1-75
Carrier phase adjustment	3-1-75
Selection of frequency standard.....	3-1-75
Latch data utility	3-1-76
Selection menu 2.....	3-1-77
Calibration	3-1-78
Latch data.....	3-1-78
Elapsed time.....	3-1-79
Locking and unlocking.....	3-1-79
Setting time and date	3-1-79
Keyboard locking	3-1-79
Display blanking	3-1-79
Power up options.....	3-1-80
RF level units	3-1-80
LF level units	3-1-80
RF level utility	3-1-81
LOW FREQUENCY OPERATION.....	3-1-85
LF monitor.....	3-1-85
Modulation source monitoring.....	3-1-85
Modulation drive monitoring.....	3-1-85
Use as an independent LF generator	3-1-86
MEMORY	3-1-87
Memory recall.....	3-1-87
Memory stepping facility.....	3-1-88
Memory store	3-1-89
Frequency hopping.....	3-1-91
ERROR HANDLING	3-1-94
Background errors.....	3-1-94
Foreground errors.....	3-1-94
GPIB errors.....	3-1-94
Error display	3-1-94

LIST OF TABLES

Table 3-1-1 List of available soft keys for analog modulation modes.....	3-1-85
Table 3-1-2 Background errors	3-1-95
Table 3-1-3 Foreground errors	3-1-95
Table 3-1-4 GPIB errors	3-1-96
Table 3-1-5 Fatal errors	3-1-97

LIST OF FIGURES

Fig. 3-1-1 2051 front panel.....	3-1-6
Fig. 3-1-2 2051 rear panel.....	3-1-8
Fig. 3-1-3 Sig Gen menu - default display for 2050	3-1-9
Fig. 3-1-4 Sig Gen menu - default display for 2051	3-1-10
Fig. 3-1-5 Sig Gen menu - default display for 2052	3-1-10
Fig. 3-1-6 Amplitude modulation - menu configuration	3-1-12
Fig. 3-1-7 RPP tripped	3-1-14
Fig. 3-1-8 Modulation mode selection menu	3-1-15
Fig. 3-1-9 Sig Gen menu with two modulation channels (composite mode)	3-1-16

Fig. 3-1-10	Sig Gen menu in digital modulation mode.....	3-1-17
Fig. 3-1-11	Digital modulation: Modulation system menu with NADC (D-AMPS) selected	3-1-18
Fig. 3-1-12	Summary of digital modulation system selection.....	3-1-19
Fig. 3-1-13	Digital modulation: Modulation system select menu with NADC (D-AMPS) selected	3-1-20
Fig. 3-1-14	Digital modulation: User defined systems select menu with USER1 selected.....	3-1-20
Fig. 3-1-15	Digital modulation: Cellular systems select menu with NADC (D-AMPS) selected	3-1-21
Fig. 3-1-16	Digital modulation: Paging systems select menu with ERMES selected.....	3-1-21
Fig. 3-1-17	Digital modulation: POCSAG systems select menu with POCSAG selected	3-1-22
Fig. 3-1-18	Digital modulation: CITYRUF systems select menu with CITYRUF selected.....	3-1-22
Fig. 3-1-19	Digital modulation: PMR systems select menu with TETRA selected.....	3-1-23
Fig. 3-1-20	Digital modulation: MD... (Bt=0.3) systems select menu with MD80 selected	3-1-23
Fig. 3-1-21	Digital modulation: MD... (Bt=0.5) systems select menu with MD36 selected	3-1-24
Fig. 3-1-22	Digital modulation: Avionic/Satellite systems select menu with TFTS selected	3-1-24
Fig. 3-1-23	Digital modulation: Cordless systems select menu with DSRR 4.0KB/s selected.....	3-1-25
Fig. 3-1-24	Digital modulation: Modulation type selection menu with $\pi/4$ DQPSK selected.....	3-1-26
Fig. 3-1-25	Digital modulation: QAM selection menu with 4QAM selected	3-1-27
Fig. 3-1-26	Digital modulation: PSK selection menu with phase offset $\pi/4$ differential QPSK selected	3-1-27
Fig. 3-1-27	Digital modulation: FSK selection menu with 4FSK selected.....	3-1-28
Fig. 3-1-28	Digital modulation: Channel filter selection menu.....	3-1-29
Fig. 3-1-29	Digital modulation: Modulation system menu with test tones selected	3-1-31
Fig. 3-1-30	Digital modulation: Data/Timing control menu	3-1-32
Fig. 3-1-31	Digital modulation: Internal data selection menu with PRBS selected	3-1-33
Fig. 3-1-32	BPSK constellation	3-1-34
Fig. 3-1-33	QPSK constellation	3-1-34
Fig. 3-1-34	8PSK constellation	3-1-35
Fig. 3-1-35	Time offset QPSK constellation	3-1-35
Fig. 3-1-36	Phase offset $\pi/2$ differential BPSK constellation	3-1-37
Fig. 3-1-37	Phase offset $\pi/4$ differential QPSK constellation	3-1-37
Fig. 3-1-38	$\pi/8$ differential 8PSK constellation.....	3-1-38
Fig. 3-1-39	4QAM constellation	3-1-38
Fig. 3-1-40	16QAM constellation	3-1-39
Fig. 3-1-41	Simplified block diagram: Digital mode with internal mixing	3-1-41
Fig. 3-1-42	Digital modulation: Modulation configuration menu	3-1-41
Fig. 3-1-43	Simplified block diagram: Digital mode with external mixing.....	3-1-42
Fig. 3-1-44	Digital modulation: Fading control menu showing Rayleigh fading selected.....	3-1-43
Fig. 3-1-45	Digital modulation: IQ modulator errors menu	3-1-44
Fig. 3-1-46	Sig Gen menu in vector modulation mode	3-1-47
Fig. 3-1-47	Simplified block diagram: Vector mode with internal mixing.....	3-1-48
Fig. 3-1-48	Vector modulation: Modulation configuration menu with internal mixer selected	3-1-48
Fig. 3-1-49	Simplified block diagram: Vector mode with external mixing	3-1-49

Fig. 3-1-50	Vector modulation: Fading control menu showing Rayleigh fading selected.....	3-1-51
Fig. 3-1-51	Sig Gen menu - default display for 2051.....	3-1-53
Fig. 3-1-52	Internal source selection menu.....	3-1-56
Fig. 3-1-53	LF phase control.....	3-1-56
Fig. 3-1-54	External source selection menu.....	3-1-57
Fig. 3-1-55	Sig Gen menu with pulse modulation selected.....	3-1-59
Fig. 3-1-56	Continuous tone selection menu.....	3-1-61
Fig. 3-1-57	Sequential calling tones utility menu.....	3-1-62
Fig. 3-1-58	Sequential calling tones utility menu (DTMF mode).....	3-1-63
Fig. 3-1-59	Calling tones mode control menu (with [FM] selected).....	3-1-64
Fig. 3-1-60	Tone standard selection menu.....	3-1-64
Fig. 3-1-61	Edit sequential tones standard menu.....	3-1-65
Fig. 3-1-62	Total shift menu.....	3-1-66
Fig. 3-1-63	Sweep parameters display.....	3-1-67
Fig. 3-1-64	Sweep type menu.....	3-1-68
Fig. 3-1-65	Sweep trigger mode menu.....	3-1-68
Fig. 3-1-66	Sweep markers menu.....	3-1-70
Fig. 3-1-67	Sweep in progress.....	3-1-70
Fig. 3-1-68	Sweep stopped.....	3-1-71
Fig. 3-1-69	RF level transferred.....	3-1-71
Fig. 3-1-70	Utilities selection menu 1.....	3-1-73
Fig. 3-1-71	Display adjust menu.....	3-1-74
Fig. 3-1-72	Latch data utility with single latch selected in binary mode.....	3-1-76
Fig. 3-1-73	Utilities selection menu 2.....	3-1-78
Fig. 3-1-74	Calibration utilities menu.....	3-1-78
Fig. 3-1-75	RF level units selection menu (shown unlocked to level 1).....	3-1-80
Fig. 3-1-76	LF level units selection menu (shown unlocked to level 1).....	3-1-81
Fig. 3-1-77	RF level utility menu.....	3-1-81
Fig. 3-1-78	Normal signal generator level control operation.....	3-1-82
Fig. 3-1-79	Extended hysteresis operation with an RF level of -9 dBm as the starting level.....	3-1-83
Fig. 3-1-80	RF offset adjustment menu.....	3-1-83
Fig. 3-1-81	RF level limit menu.....	3-1-84
Fig. 3-1-82	LF generator menu.....	3-1-86
Fig. 3-1-83	Memory recall menu.....	3-1-87
Fig. 3-1-84	Memory stepping menu.....	3-1-89
Fig. 3-1-85	Memory store menu.....	3-1-90
Fig. 3-1-86	Frequency hopping menu.....	3-1-92

INTRODUCTION

This chapter explains how to:

- Set up the signal generator to produce a typical basic signal.
- Select the main operating parameters; carrier frequency, output level and type of modulation.
- Use the full range of supporting facilities.

Note..

When connecting the PULSE INPUT connector to external equipment, a double screened coaxial cable should be used in order for the instrument to conform to EMC requirements.

CONVENTIONS

The following conventions are used in this chapter:

- RF OUTPUT Capitals refer to titles marked on the panel.
- [MEM] Text in square brackets indicate hard key titles.
- Int. F4* Italics refer to data or messages on the display.
- [Pulse] Italics in square brackets indicate soft key titles, e.g. [Pulse] means the soft key adjacent to the *Pulse* title box at the side of the menu.

FRONT PANEL

Parameters are selected by means of hard keys, which have their function printed on them, soft keys, which do not have any notation, a numerical key pad and a rotary control knob, see Fig. 3-1-1. The hard keys have functions which do not change, whereas the soft key functions are determined by the menu which is being displayed. The numerical keys are used to set parameters to specific values which can also be varied in steps of any size by using the \uparrow/\downarrow keys or the rotary control knob.

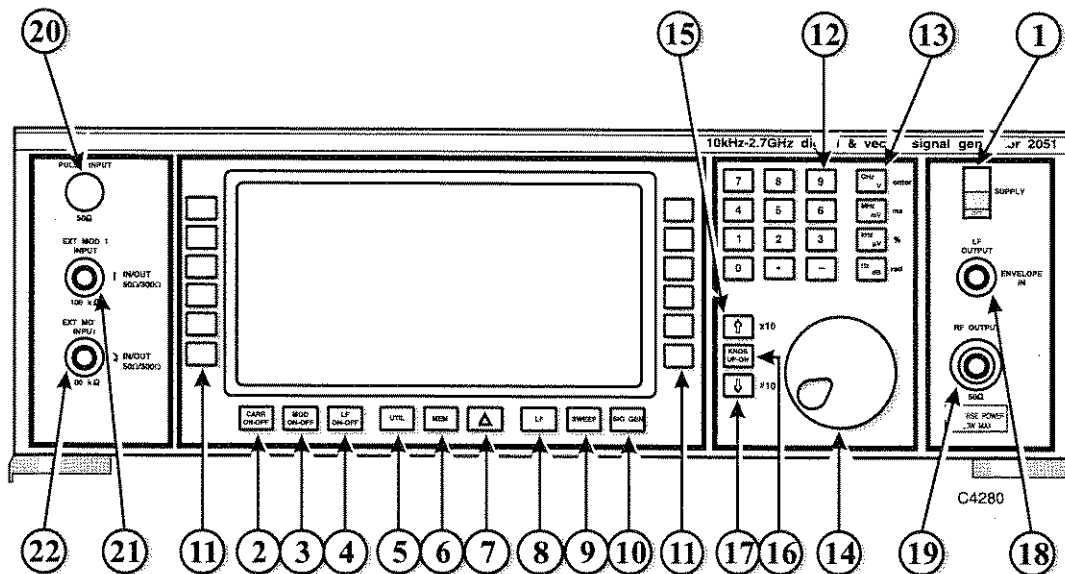

Fig. 3-1-1 2051 front panel.

- | | | |
|------|------------------------------------|--|
| (1) | SUPPLY | Switches the AC supply voltage on and off. |
| (2) | CARR ON-OFF | Enables or disables the carrier frequency. |
| (3) | MOD ON-OFF | Enables or disables the modulation. |
| (4) | LF ON-OFF | Switches the low frequency output on and off. |
| (5) | UTIL | Displays the utilities menu. |
| (6) | MEM | Displays the memory store/recall menu. |
| (7) | Δ | Displays the total shift menu. |
| (8) | LF | Displays the LF and monitor menus. |
| (9) | SWEEP | Displays the sweep status menu. |
| (10) | SIG GEN | Displays the main menu. |
| (11) | SOFT KEYS; | Twelve function keys change notation as the menu changes. |
| (12) | NUMERICAL
KEY PAD | For changing the value of a selected parameter. Minus sign and decimal point are included. |
| (13) | UNITS KEYS | Determine the units of set parameters and terminate the numerical entry. |
| (14) | CONTROL KNOB | When enabled, adjusts the value of the selected parameter. |
| (15) | $\uparrow \times 10$ | When knob disabled, increments a selected parameter. When knob enabled, increases knob sensitivity by factor of ten. |
| (16) | KNOB UP-DN | Switches between control knob and $\uparrow \downarrow$ keys. |
| (17) | $\downarrow \div 10$ | When knob disabled, decrements a selected parameter. When knob enabled, decreases knob sensitivity by factor of ten. |
| (18) | LF OUTPUT | BNC socket provides a low impedance output at the frequency selected at the <i>LF GENERATOR MENU</i> or monitors the modulating signal. |
| | ENVELOPE IN | In both vector and digital modes, enables a control voltage to vary the RF OUTPUT level. |
| (19) | RF OUTPUT | 50 Ω N type socket with reverse power protection. |
| (20) | PULSE
INPUT | 50 Ω BNC socket (if fitted) accepts a pulsed signal. |
| (21) | EXT MOD 1
INPUT | 100 k Ω BNC socket. An independent input which allows an external modulation signal to be applied. |
| | I IN/OUT 50 Ω /300 Ω | In vector operation this socket has a menu-selectable 50 Ω or 300 Ω input impedance. In digital mode provides the I (in phase) channel modulation output signal. In vector mode allows a voltage to vary the I component of the RF output. |

- (22) EXT MOD 2 INPUT 100 k Ω BNC socket, similar to (21).

Q IN/OUT 50 Ω /300 Ω In vector operation this socket has a menu-selectable 50 Ω or 300 Ω input impedance. In digital mode provides the Q (quadrature) channel modulation output signal. In vector mode enables a voltage to vary the Q component of the RF output.

REAR PANEL

The following facilities are available on the rear panel, see Fig. 3-1-2.

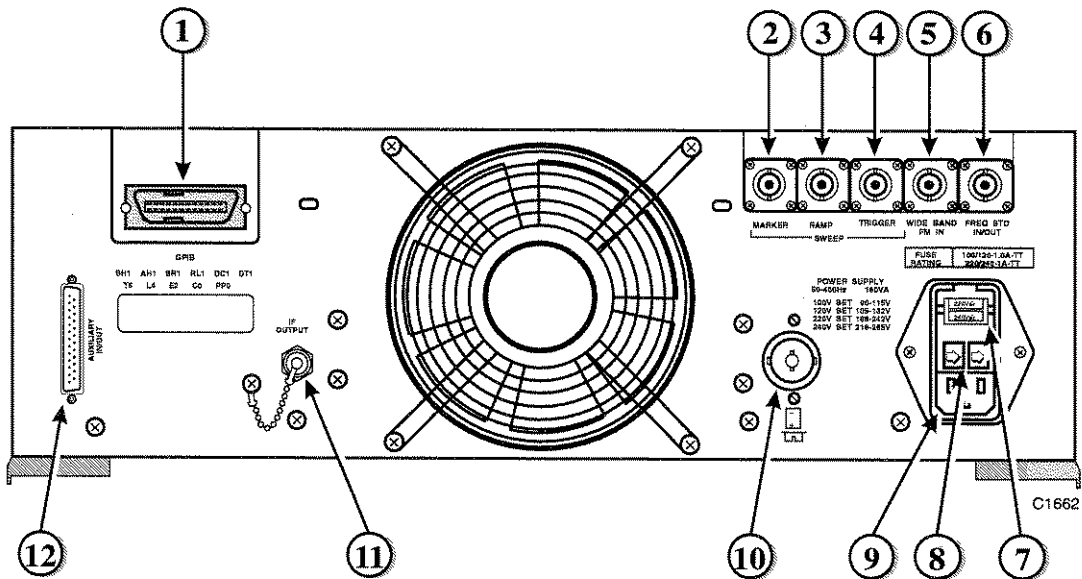

Fig. 3-1-2 2051 rear panel

- | | | |
|-----|------------------|--|
| (1) | GPIB | 24 pin socket accepts standard IEEE connector to allow remote control of the instrument. |
| (2) | SWEEP MARKER | BNC socket supplies sweep marker. |
| (3) | SWEEP RAMP | BNC socket provides a ramp output at 0 to 10 V peak to peak. |
| (4) | SWEEP TRIGGER | BNC socket provides access for a trigger input. |
| (5) | WIDE BAND FM IN | BNC socket accepts a wide bandwidth FM signal into 50 Ω with a typical bandwidth of 10 MHz. |
| (6) | FREQ STD IN/OUT | BNC socket for standard frequencies at 1, 5, or 10 MHz at TTL levels. |
| (7) | VOLTAGE SELECTOR | Removable cover reveals barrel which can be rotated to select the required voltage range. |

- (8) FUSES AC fuses rated at 1.6 A (time lag) for the 100 to 120 V range and 1 A (time lag) for the 220 to 240 V range.
- (9) AC SUPPLY INPUT 3 pin plug integral with voltage selector and fuse holders. Mates with supply lead socket.
- (10) BATTERY HOLDER Houses battery for real time clock.
- (11) IF OUTPUT BNC socket supplies an IF modulated by the selected digital or vector modulation. Can be used with an external mixer.
- (12) AUXILIARY IN/OUT 25-pin plug. Can accept external data to modulate the RF OUTPUT level or be used to control external devices. For pin-out see 'Auxiliary I/O connector' in Chapter 2.

THE MENUS

The 2050 Series instruments are operated by calling up various displays or menus on the screen. Menus are accessed via both hard and soft keys. Pressing a hard key normally causes the appropriate primary menu to appear on the screen regardless of the current working position within the menu hierarchy. As the display changes from one menu to another, so the 12 soft keys assume those functions necessary to drive the instrument from that menu. Secondary menus are displayed by pressing a soft key while in a primary menu. Some sub-menus are nested e.g. UTILITIES. Clearance from these is obtained by pressing the [EXIT] or [UTIL] key.

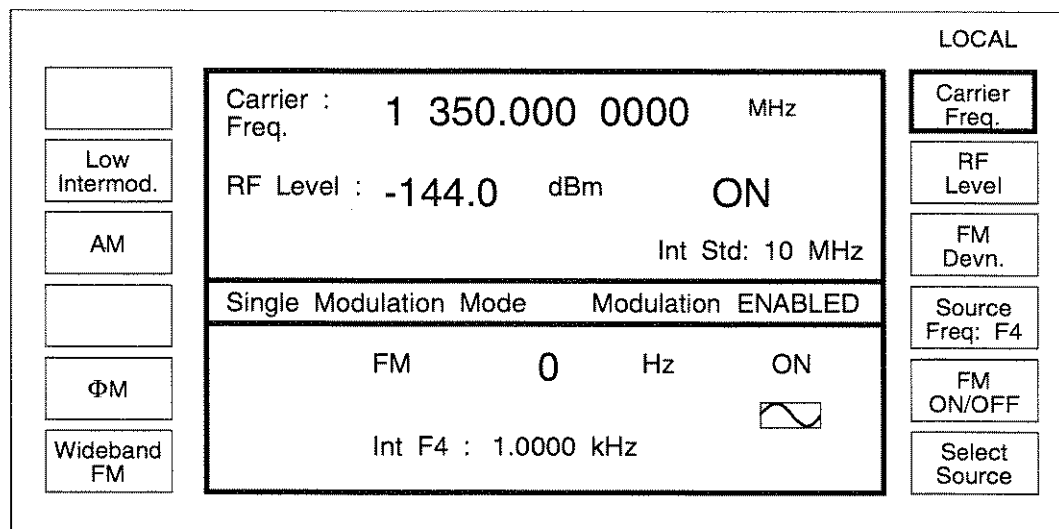

C1885

Fig. 3-1-3 Sig Gen menu - default display for 2050

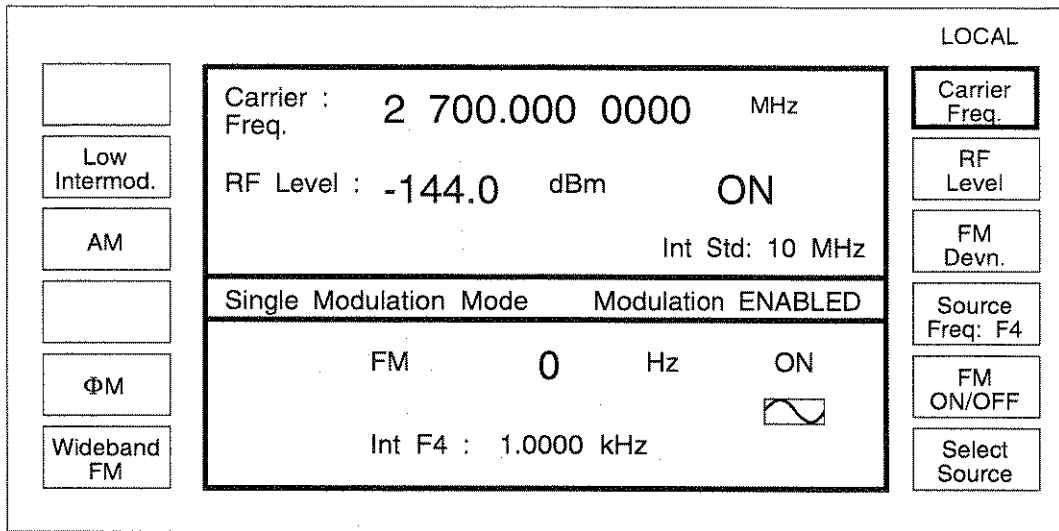

C0482

Fig. 3-1-4 Sig Gen menu - default display for 2051

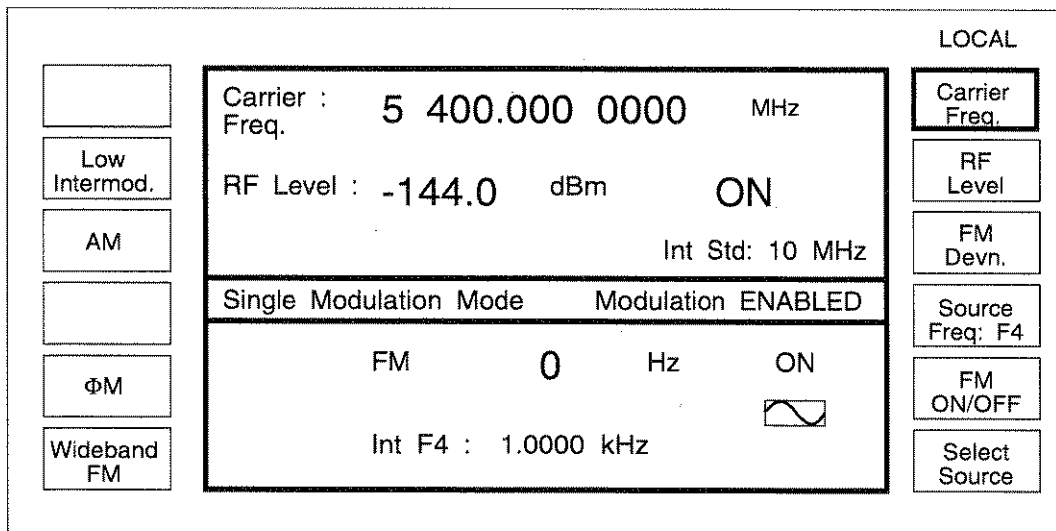

C0483

Fig. 3-1-5 Sig Gen menu - default display for 2052

FIRST TIME USE

First time users can quickly become familiar with the principles of control and display by carrying out the following exercise, which demonstrates how to set up a typical basic signal having the following parameters:

Carrier frequency:	100 MHz.
Output level:	10 dBm.
Amplitude modulation:	30% depth at 1 kHz.

Switching on

- (1) Before switching the instrument on, check that the voltage selector has been set to the value of the power supply as described in Chap. 2, and that no signal voltage is present on the PULSE INPUT socket.
- (2) If the default display shown in Fig. 3-1-3 or Fig. 3-1-4 or Fig. 3-1-5 is not obtained, a previous user may have set the instrument to switch on with one of the user memories recalled rather than using the default factory settings. Before proceeding any further you should reset this selection, see 'Power up options'. Switch off and on again. Alternatively use the [MEM] key followed by entering 50 and terminating by pressing the [enter] key. This will reset the instrument to the factory default setting.

If the RF level units and the internal/external standard are not as shown, they can be changed as described on Page 3-1-80, 'RF level units' and Page 3-1-75 'Selection of frequency standard'.
- (3) Observe that the main menu appears on the display showing default parameters for FM. The soft key label marked [*Carrier Freq.*] is highlighted (i.e. the line bordering the label is increased in thickness to about 1 mm), which means that anything entered at this stage will change the carrier frequency.
- (4) If necessary, adjust the display for brightness and contrast, see 'UTILITIES' Page 3-1-73.

Changing the value of the selected parameter

If an error is made when keying in, press the soft key again and key in the correct value. If an error message is displayed, it can be cancelled by entering a value which is within limits.

- (1) Using the numerical key pad, enter 100 MHz by pressing keys [1], [0], [0] and the key marked [MHz/mV/ms]. Observe that the Carrier Freq. display changes to *100.000 0000* MHz.
- (2) Press [*RF level*]. The *RF level* soft key label is now highlighted.
- (3) Using the numerical key pad, enter 10 dBm by pressing keys [1], [0] and the key marked [Hz/dB/rad]. Observe that the RF Level display changes to *10.0 dBm*.
- (4) Press [*AM*] on the left-hand side of the display. The menu will now change to display AM modulation parameters in the lower panel. The [*FM Devn.*] soft key on the right hand side of the menu changes to [*AM depth*] and this label is now highlighted. *AM* disappears from the left-hand side.
- (5) Using the numerical key pad, enter 30% AM depth by pressing [3], [0] and [kHz/ μ V/%]. Observe that the *AM depth* display changes to *30%*. The display will now be as in Fig. 3-1-6 and the selected signal will now be present at the RF OUTPUT socket.

Enabling or disabling the modulation

The modulation is ON by default, but the AM can be turned ON and OFF by pressing [AM ON/OFF] at the right hand side of the display and the modulation can be enabled or disabled by pressing [MOD ON-OFF]. These are both toggle actions, i.e. press ON, press OFF. The soft key acts only on the selected modulation whereas the [MOD ON-OFF] acts on all modulations.

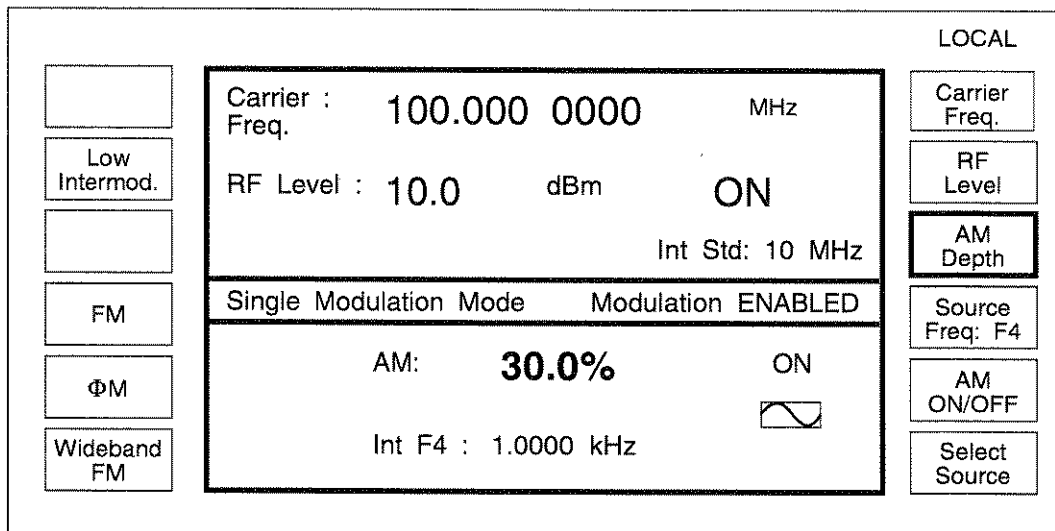

Fig. 3-1-6 Amplitude modulation - menu configuration

C1886

Using the [$\uparrow \times 10$] and [$\downarrow \div 10$] keys

When a parameter has been selected via the numerical key pad, its value can be incremented or decremented either in steps using the [\uparrow] key and the [\downarrow] key, or continuously with the control knob. Select [Carrier Freq.] and observe that the effect of pressing the [\uparrow] and [\downarrow] keys is to change the carrier frequency in steps of 1 kHz. Default step sizes are assigned to all parameters but these can be changed, see 'INCREMENTING (using Δ)'.

Using the control knob

- (1) Press [KNOB UP-DN] to enable the control knob.
- (2) On the display, brackets will appear above and below the selected parameter. These brackets embrace the part of the value which the control knob can change. Pressing the [$\times 10$] key shortens the bracket length by one decimal place. Pressing the [$\div 10$] key increases the bracket length by one decimal place. In this way the sensitivity of the control knob can be increased or decreased by a factor of ten.
- (3) Rotate the control knob and observe the change in the selected parameter. Press [KNOB UP-DN] to disable the knob.
- (4) For other parameters, press the relevant soft key and use the [\uparrow] and [\downarrow] keys or the control knob.

Note...

For *RF Level* the knob resolution is fixed at 0.1 dB.

DETAILED OPERATION

CARRIER FREQUENCY

The carrier frequency is selected from the *Sig Gen* menu by pressing [*Carrier Freq.*], unless it is already highlighted as in the default display.

Enter the required value via the numerical key pad. The value can then be incremented or decremented using the control knob and its associated keys, [KNOB UP-DN], [$\times 10$] and [$\div 10$].

If a value outside the specified range is requested, the message:

ERROR 51: Carrier Outside Limits

is displayed on the screen when the terminator key is pressed, and the instrument is automatically set to the end of the range.

Carrier ON/OFF

The carrier may be switched *ON* or *OFF* at any time via the [CARR ON-OFF] key. This effectively switches the output ON and OFF, retaining the 50 Ω output impedance.

OUTPUT LEVEL

The output level is selected at the *Sig Gen* menu by pressing [*RF Level*] and entering the required value on the numerical key pad. The value can then be incremented or decremented using the control knob and its associated keys, [KNOB UP-DN], [$\times 10$] [$\div 10$]. If a value outside the specified range is requested the message:

ERROR 52: RF Level Outside Limits

or

ERROR 17: RF Level limited by AM

is displayed and the instrument is automatically set to the end of the range.

Note...

The knob resolution is fixed at 0.1 dB.

Choice of units

Units may be μV , mV, V or dB. Conversion between dB and the voltage units is carried out by pressing the appropriate units key, i.e. to change dBm to a voltage unit, press any voltage key for the correct conversion. The choice of Volts EMF, Volts PD, and the dB reference is made by using the [*RF Level Units*] utility, see Page 3-1-80, 'RF level units'.

Reverse power protection

Accidental application of power to the RF OUTPUT socket trips the reverse power protection circuit (RPP) and a flashing message appears on the display, see Fig. 3-1-7.

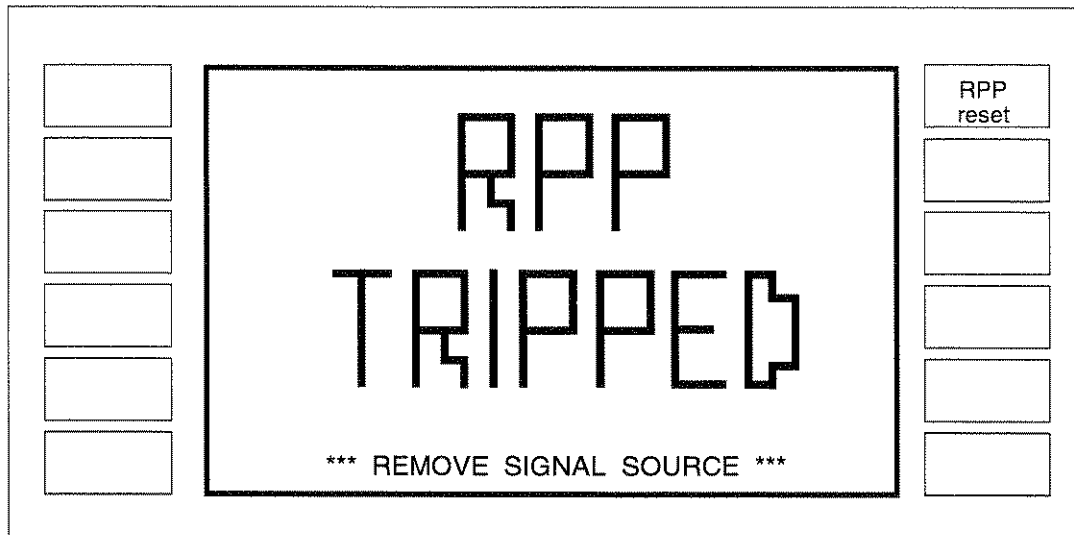

C0004

Fig. 3-1-7 RPP tripped

Pressing [*RPP Reset*] resets the RPP and returns the display to the menu in use when the reverse power protection was tripped. If [*RPP Reset*] is pressed with the signal still applied, the RPP will trip again.

MODULATION

The carrier frequency can be modulated by conventional analog methods - frequency, amplitude, phase (with pulse modulation as an option) - as well as the more complex modulation techniques - PSK, QAM, FSK, GMSK, IQ.

Complex modulation modes

Digital

In the digital mode of operation the instrument can generate user-defined modulation formats from either an internal data source or accept external data. Modulation can be applied in PSK, FSK, GMSK and QAM formats with specified channel filter characteristics.

Vector

In the vector mode of operation the instrument provides IQ modulation of the carrier from an external source by using the I IN/OUT and Q IN/OUT connectors on the front panel.

Analog modulation modes

Two independent inputs on the front panel - EXT MOD 1 INPUT, EXT MOD 2 INPUT - allow external modulation signals to be summed with signals from the internal oscillator and a second optional internal oscillator (if fitted). Thus up to four analog modulations may be available at one time. These can be combined to give single, dual, composite and dual composite modes of operation.

Single

In the single mode, only one modulation can be active at any one time. Selecting another modulation mode cancels the first.

Dual

In the dual mode, a common carrier wave is modulated by two different types of modulation, e.g. one AM and one FM. Each type of modulation can carry separate information.

Composite

This mode consists of two modulating channels of the same type of modulation (e.g. FM1 + FM2) with the effective modulation being the sum of the two waveforms.

Dual composite

This mode is similar to the composite mode of operation but with the two modulating channels being the sum of two sources, e.g. FM1 + FM2 and AM1 + AM2.

Modulation mode selection

In order to select a different modulation mode:

- (1) Press [UTIL]. *Utilities Selection Menu 1* will appear on the display.
- (2) Press the [Mod'n Mode] key. This calls up the *Modulation Mode Selection Menu* shown in Fig. 3-1-8. The six possible modulation modes are shown. Press the required soft key.

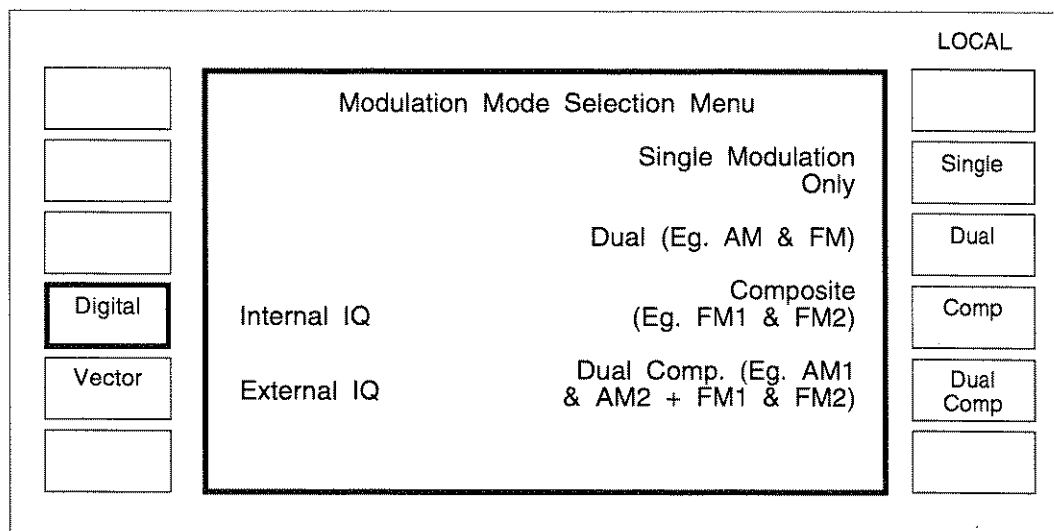

C0840

Fig. 3-1-8 Modulation mode selection menu

Note...

If the Avionics option (Option 006) is fitted an additional soft key [Avionics Modes] will be displayed. See Annex A for avionics modes selection.

- (3) Press [SIG GEN] to return to the *Sig Gen* menu where the modulation mode and individual source parameters (where applicable) will be shown. For composite mode selection a menu similar to Fig. 3-1-9 will be displayed.

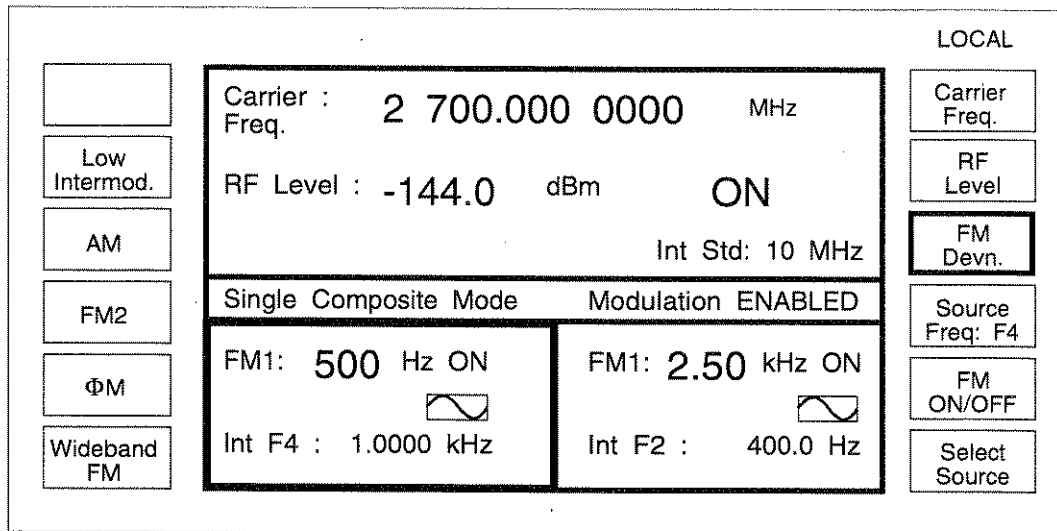

C0485

*Fig. 3-1-9 Sig Gen menu with two modulation channels
(composite mode)*

Note...

Full information on the range of utilities can be found under 'UTILITIES'.

DIGITAL MODULATION MODE

DIGITAL MODULATION

In the digital mode of operation the instrument can generate user-defined modulation formats from either an internal or external data source. Modulation can be applied in FSK, GMSK, PSK and QAM formats with specified channel filter characteristics. When defined these parameters may be stored and subsequently recalled. The RF level can be varied by applying an envelope control voltage. Modulation errors and fading effects can be simulated. Provision is also made for using an external mixer to generate a modulated carrier at a higher frequency than can be provided internally by the instrument.

To select the Digital control function press the *[Digital]* key on the *Modulation Mode Selection Menu* (see Fig. 3-1-8), followed by *[SIG GEN]*. This causes the *Sig Gen* menu shown in Fig. 3-1-10 to be displayed.

		LOCAL
	Carrier : 2 700.000 0000 MHz	Carrier Freq.
IQ Selfcal	RF Level : -138.0 dBm ON	RF Level
	Int Std: 10 MHz	
Config. Select	Digital Mod'n Mode Modulation ENABLED	Mod'n System
Fading Control	CONFIGURATION:	Data / Timing
IQ Errors	Sideband: UPPER	
	IF : 132 MHz	
	Envelope: DISABLED	
	Fading : DISABLED	
	IQ Errors: DISABLED	
	DATA:	
	Internal PRBS (n=15)	
	Type : $\pi/4$ DQPSK	
	Rate : 24.3000 kHz	
	Filter : Root Nyquist	
	Alpha: 0.35	

C2431

Fig. 3-1-10 Sig Gen menu in digital modulation mode

Setting the output carrier

In digital modulation mode the carrier output frequency and level are set by pressing the *[Carrier Freq.]* and *[RF Level]* keys respectively and entering the values in the normal way.

Self-calibration

To achieve the high precision of the complex modulation the 2050 series Signal Generators have an IQ self-calibration feature which automatically adjusts the modulator for optimum performance minimising vector errors. The instrument generates a warning message at the top of the screen when an IQ self-calibration is advisable. This will occur 30 minutes after power-on and thereafter at 3 hour intervals.

To perform a self-calibration press *[IQ Selfcal]*. The calibration process is entirely automatic and during operation the message *IQ MODULATOR CALIBRATION IN PROGRESS PLEASE WAIT ...* appears. Calibration takes approximately 45 seconds and normally remains valid for 3 hours.

Setting the digital modulation system

The [Mod'n System] key on the *Sig Gen* menu (Fig. 3-1-10) is used to select the modulation system or type, set the channel filter characteristics and set the symbol data rate. User defined systems can be created and stored for subsequent recall. Providing Test Tones has not been selected, pressing the [Mod'n System] key causes the *Digital Modulation System Menu* shown in Fig. 3-1-11 to be displayed. If Test Tones has been selected, the *Digital Modulation System Menu* shown in Fig. 3-1-29 is displayed instead.

		LOCAL
Select System	Digital Modulation System Menu	Symbol Rate
Select Mod Type	Current System: NADC	Filter Alpha
Filter Type	Modulation Type : $\pi/4$ DQPSK	
	Symbol Size : 2 bits	
	Symbol Rate : 24.3000 kHz	
	Filter Type : Root Nyquist	
	Filter Alpha : 0.35 - - - -	Store to USER "n"

C2432

Fig. 3-1-11 Digital modulation: Modulation system menu with NADC (D-AMPS) selected

Modulation type and system selection

The type of modulation to be generated can be set either by selecting a preset system (either user-defined or predefined) using the [Select System] key or by defining the type of modulation (FSK, GMSK, PSK, QAM,) using the [Select Mod Type] key. Symbol rate, filter type and filter bandwidth may also be specified. System selection is summarized in Fig. 3-1-12.

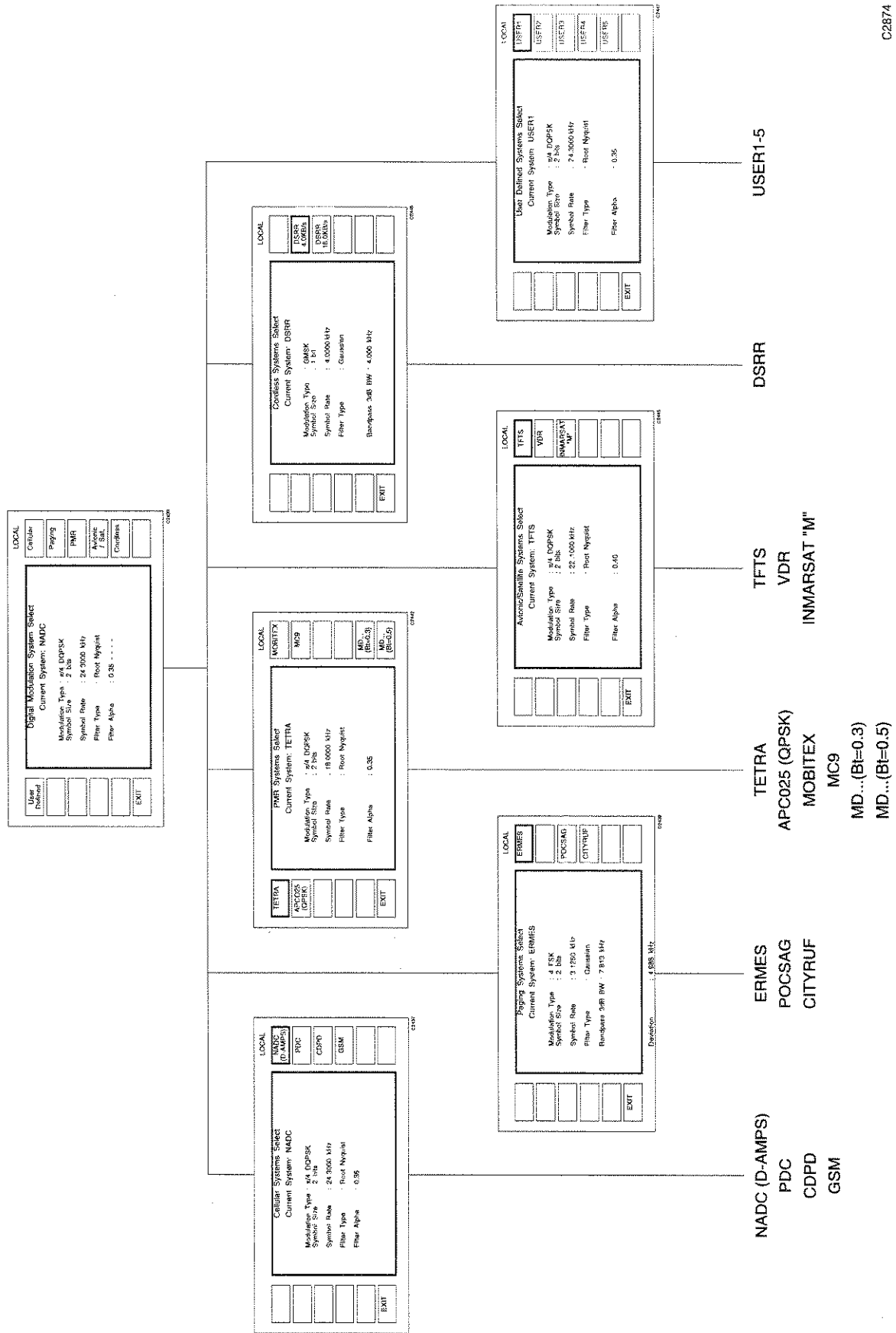
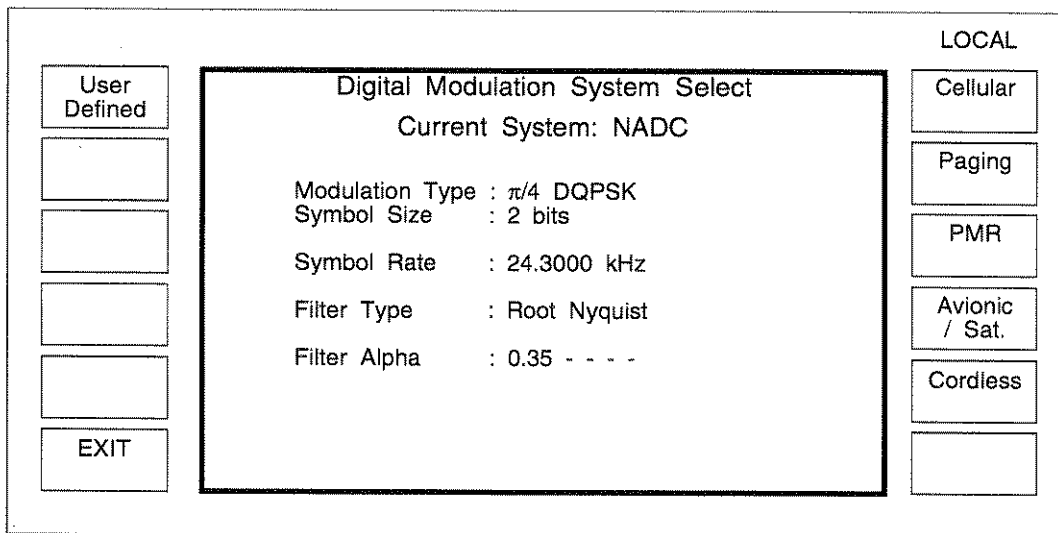

Fig. 3-1-12 Summary of digital modulation system selection

Storing a user-defined system

When a modulation system has been defined the setting can be stored in one of five non-volatile stores. To do this, press the *[Store to User "n"]* key which causes the additional message *Store to User:-* to be displayed. Enter a user number in the range 1 to 5 and follow by *[enter]*. Entering a number outside this range causes the message *Error 50: Out of Range* to be displayed and the user number must be re-entered. A stored system can be recalled from the *System Select* menu shown in Fig. 3-1-13.

To select a preset modulation system, press *[Select System]* which displays a further menu (see Fig. 3-1-13 below).



C2433

Fig. 3-1-13 Digital modulation: Modulation system select menu with NADC (D-AMPS) selected

Selecting *[Cellular]*, *[Paging]*, *[PMR]*, *[Avionic/Sat.]* or *[Cordless]* displays a further menu which allows predefined modulation systems to be selected (e.g. NADC, PDC, ERMES, POCSAG). These menus are described below.

Selecting *[User Defined]* displays a further menu (see Fig. 3-1-14 below) which allows a modulation system previously stored as a user defined system to be recalled by a single key press of the *[USER1]* to *[USER5]* keys. Pressing *[EXIT]* returns to the *Digital Modulation System Select* menu (Fig. 3-1-13).

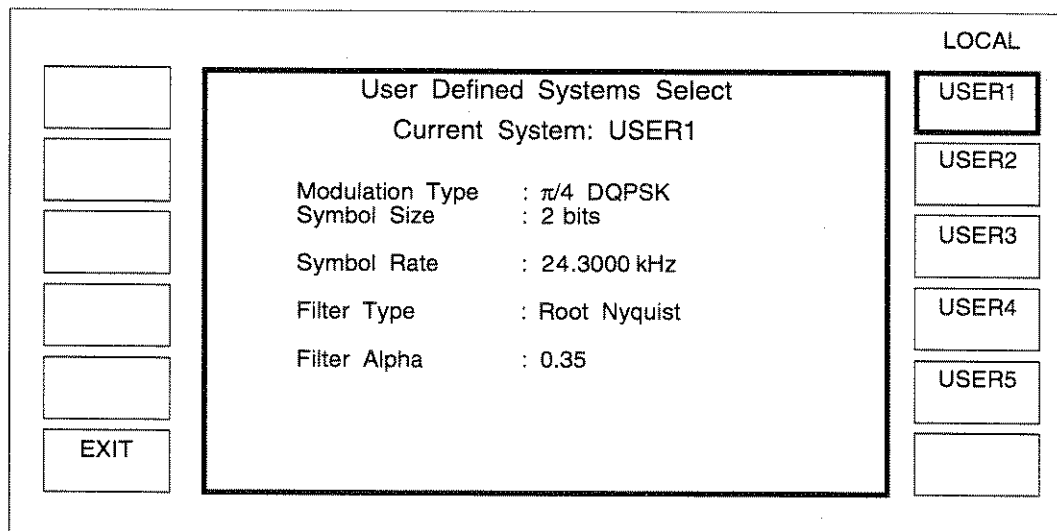

C2447

Fig. 3-1-14 Digital modulation: User defined systems select menu with USER1 selected

Cellular systems selection

Pressing the [Cellular] key displays the *Cellular Systems Select* menu shown in Fig. 3-1-15.

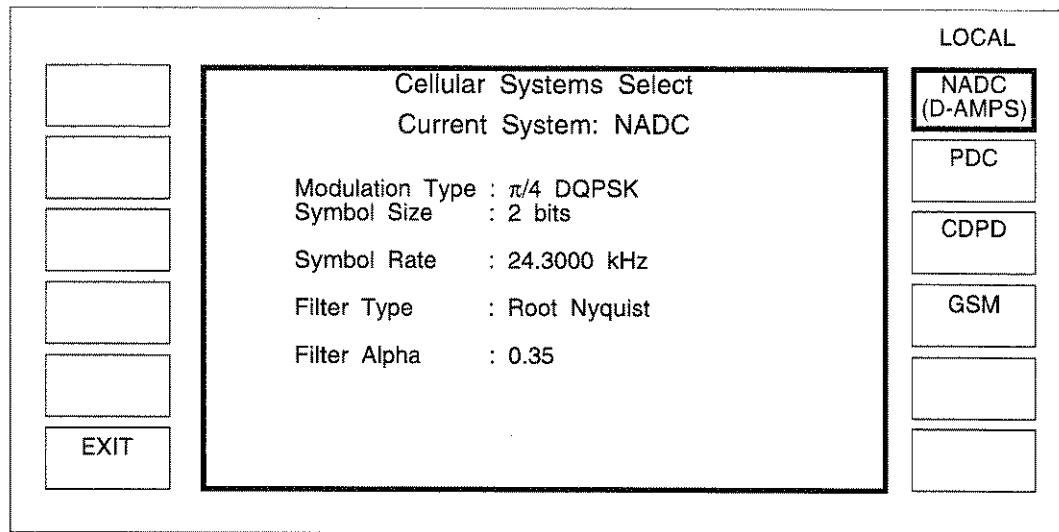

C2875

Fig. 3-1-15 Digital modulation: Cellular systems select menu with NADC (D-AMPS) selected

Pressing [NADC], [PDC], [CDPD] or [GSM] respectively selects NADC (D-AMPS), PDC, CPDP or GSM as the current modulation system.

Menu exit

Pressing [EXIT] returns to the *Digital Modulation System Select* menu (Fig. 3-1-13).

Paging systems selection

Pressing the [Paging] key displays the *Paging Systems Select* menu shown in Fig. 3-1-16.

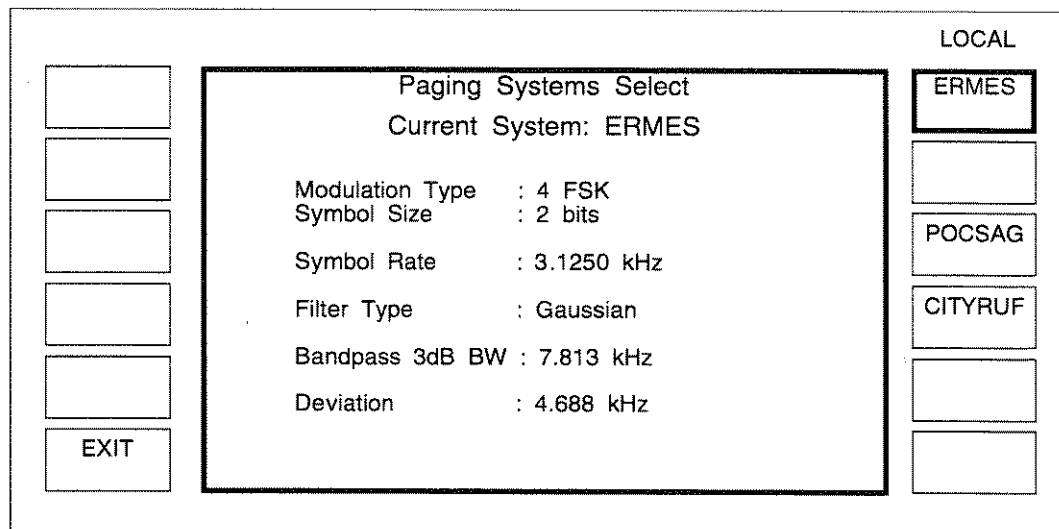

C2438

Fig. 3-1-16 Digital modulation: Paging systems select menu with ERMES selected
Pressing [ERMES] selects ERMES as the current modulation system.

Selecting [POCSAG] or [CITYRUF] displays a further menu (see Fig. 3-1-17 or Fig. 3-1-18 respectively below) which allows POCSAG or CITYRUF systems with a specific bit rate to be selected.

	POCSAG Systems Select	LOCAL
	Current System: POCSAG	512B/s
	Modulation Type : 2 FSK	1200B/s
	Symbol Size : 1 bit	2400B/s
	Symbol Rate : 1.2000 kHz	4800B/s
	Filter Type : Gaussian	
	Bandpass 3dB BW : 7.200 kHz	
	Deviation : 4.500 kHz	
EXIT		

C2439

Fig. 3-1-17 Digital modulation: POCSAG systems select menu with POCSAG selected

	CITYRUF Systems Select	LOCAL
	Current System: CITYRUF	512B/s
	Modulation Type : 2 FSK	1200B/s
	Symbol Size : 1 bit	2400B/s
	Symbol Rate : 0.5120 kHz	4800B/s
	Filter Type : Gaussian	
	Bandpass 3dB BW : 3.072 kHz	
	Deviation : 4.000 kHz	
EXIT		

C2441

Fig. 3-1-18 Digital modulation: CITYRUF systems select menu with CITYRUF selected

Menu exit

Pressing [EXIT] returns to the Digital Modulation System Select menu (Fig. 3-1-13).

PMR systems selection

Pressing the [PMR] key displays the *PMR Systems Select* menu shown in Fig. 3-1-19.

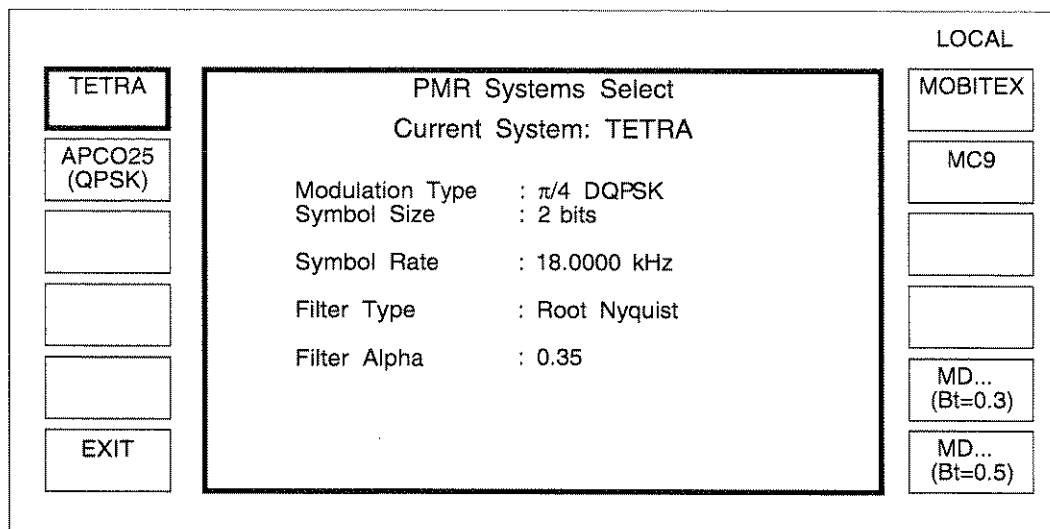

The image shows a terminal-style menu titled "PMR Systems Select" with "Current System: TETRA". The menu is enclosed in a rectangular border. On the left side, there is a vertical column of buttons: "TETRA" (highlighted with a thick border), "APCO25 (QPSK)", three empty boxes, and "EXIT". On the right side, there is a vertical column of buttons: "LOCAL", "MOBITEX", "MC9", two empty boxes, "MD... (Bt=0.3)", and "MD... (Bt=0.5)". The central area contains the following text: "Modulation Type : $\pi/4$ DQPSK", "Symbol Size : 2 bits", "Symbol Rate : 18.0000 kHz", "Filter Type : Root Nyquist", and "Filter Alpha : 0.35".

C2442

Fig. 3-1-19 Digital modulation: PMR systems select menu with TETRA selected

Pressing [TETRA], [APCO25], [MOBITEX] or [MC9] respectively selects TETRA, APCO 25 (QPSK), MOBITEX or MC9 as the current modulation system.

Selecting [MD... (Bt=0.3)] or [MD... (Bt=0.5)] displays a further menu (see Fig. 3-1-20 and Fig. 3-1-21 respectively below) which allows MD systems with a specific bit rate and Bt product to be selected.

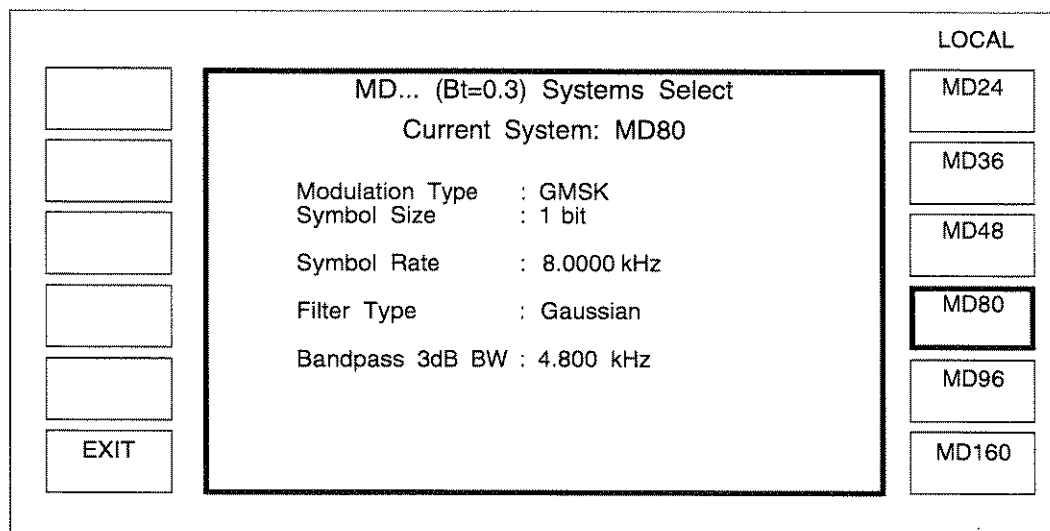

The image shows a terminal-style menu titled "MD... (Bt=0.3) Systems Select" with "Current System: MD80". The menu is enclosed in a rectangular border. On the left side, there is a vertical column of buttons: five empty boxes and "EXIT". On the right side, there is a vertical column of buttons: "LOCAL", "MD24", "MD36", "MD48", "MD80" (highlighted with a thick border), "MD96", and "MD160". The central area contains the following text: "Modulation Type : GMSK", "Symbol Size : 1 bit", "Symbol Rate : 8.0000 kHz", "Filter Type : Gaussian", and "Bandpass 3dB BW : 4.800 kHz".

C2443

Fig. 3-1-20 Digital modulation: MD... (Bt=0.3) systems select menu with MD80 selected

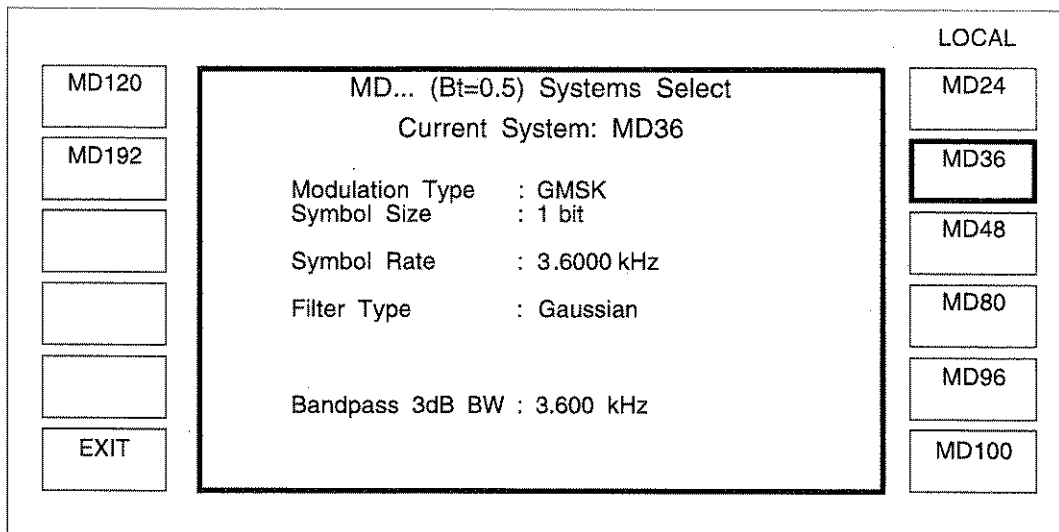

C2892

Fig. 3-1-21 Digital modulation: MD... (Bt=0.5) systems select menu with MD36 selected

Menu exit

Pressing [EXIT] returns to the Digital Modulation System Select menu (Fig. 3-1-13).

Avionic/Satellite systems selection

Pressing the [Avionic/ Sat.] key displays the Avionic/Satellite Systems Select menu shown in Fig. 3-1-22.

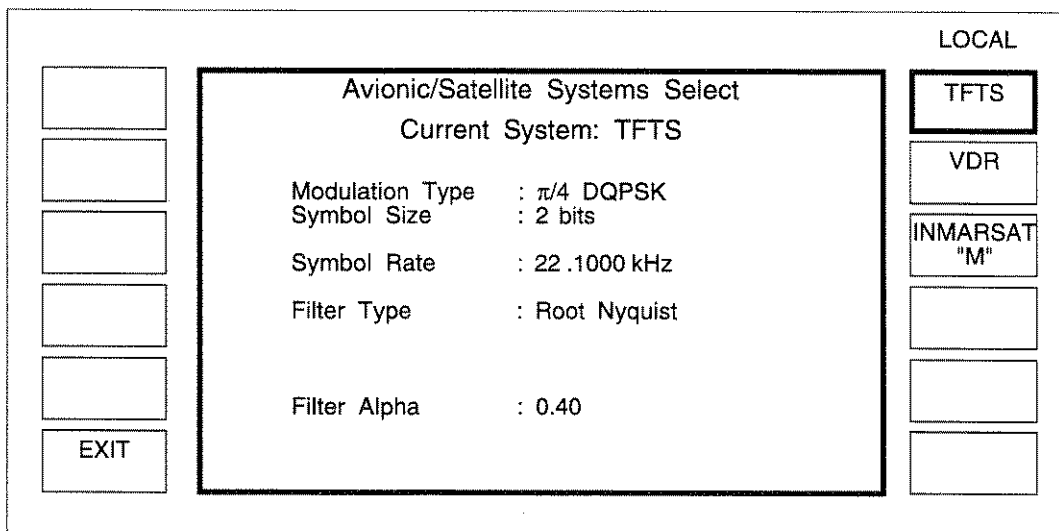

C2876

Fig. 3-1-22 Digital modulation: Avionic/Satellite systems select menu with TFTS selected

Pressing [TFTS], [VDR] or [INMARSAT "M"] selects TFTS, VDR or INMARSAT "M" as the current modulation system.

Menu exit

Pressing [EXIT] returns to the *Digital Modulation System Select* menu (Fig. 3-1-13).

Cordless systems selection

Pressing the [Cordless] key displays the *Cordless Systems Select* menu shown in Fig. 3-1-23.

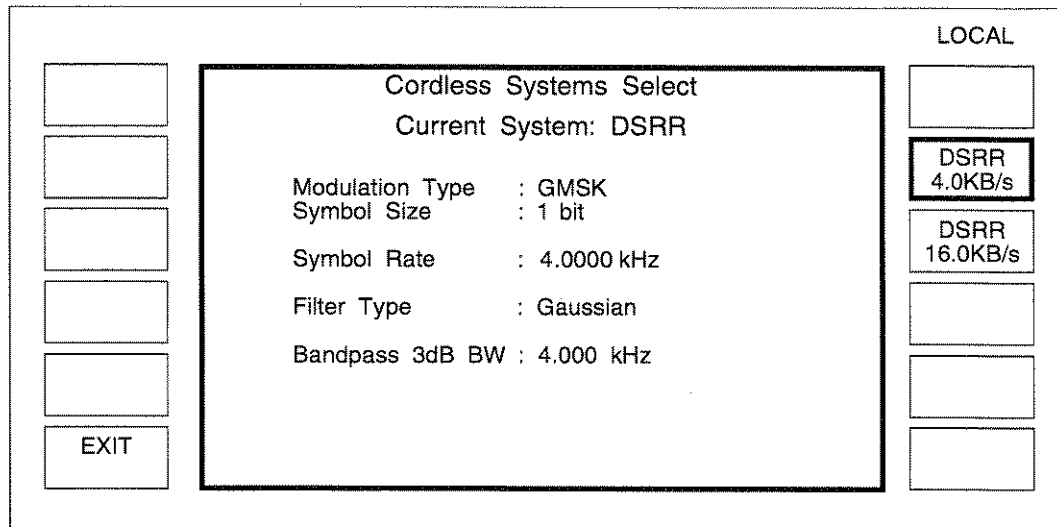

C2446

Fig. 3-1-23 Digital modulation: Cordless systems select menu with DSRR 4.0KB/s selected

Pressing [DSRR 4.0KB/s] or [DSRR 16.0KB/s] selects Digital Short Range Radio as the current modulation system with the appropriate bit rate.

Menu exit

Pressing [EXIT] returns to the *Digital Modulation System Select menu* (Fig. 3-1-13).

Pressing [EXIT] again returns to the *Digital Modulation System Menu* (Fig. 3-1-11).

Creating a modulation system

To define a modulation system not included in the *Modulation System Menu* the modulation type, symbol rate, filter type and filter bandwidth must be specified.

Selecting the modulation type

Pressing the *[Select Mod Type]* key displays the *Digital Modulation Type Selection* menu shown in Fig. 3-1-24 which allows the modulation type to be set to QAM, PSK, FSK or GMSK.

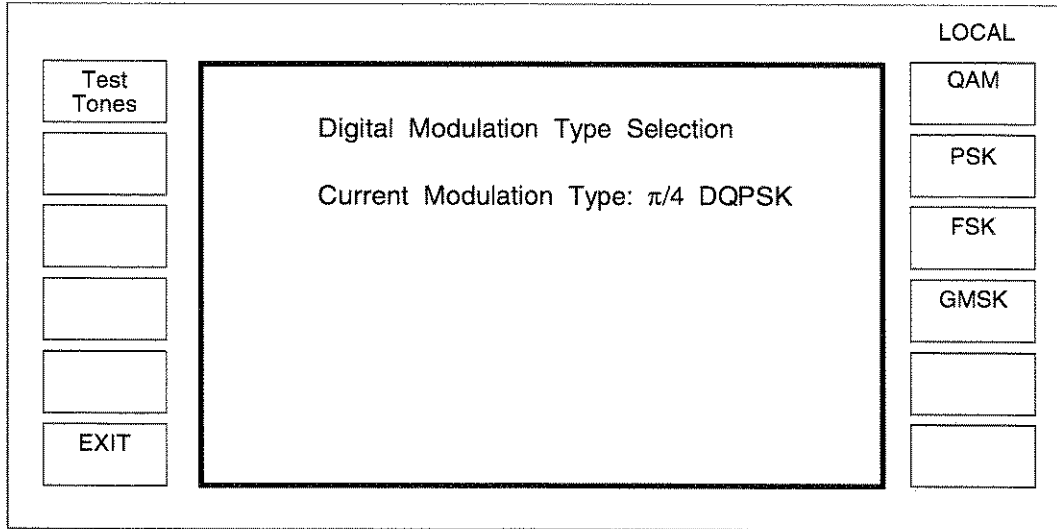

C2434

Fig. 3-1-24 Digital modulation: Modulation type selection menu with $\pi/4$ DQPSK selected

Selecting *[QAM]*, *[PSK]* or *[FSK]* displays a further menu (see Fig. 3-1-25, 3-1-26 or 3-1-27 respectively below).

Pressing *[GMSK]* selects GMSK as the current modulation type.

Pressing *[Test Tones]* enters the Test Tones utility which is mainly used for diagnostic purposes (see 'Test Tones utility' below).

Pressing *[EXIT]* returns to the *Digital Modulation System Menu* (Fig. 3-1-11).

Note...

For the detail on how data is mapped on the RF carrier see 'Digital data mapping' on page 3-1-34 below.

QAM selection menu

For quadrature amplitude modulation pressing the [QAM] key displays the QAM Selection Menu shown in Fig. 3-1-25.

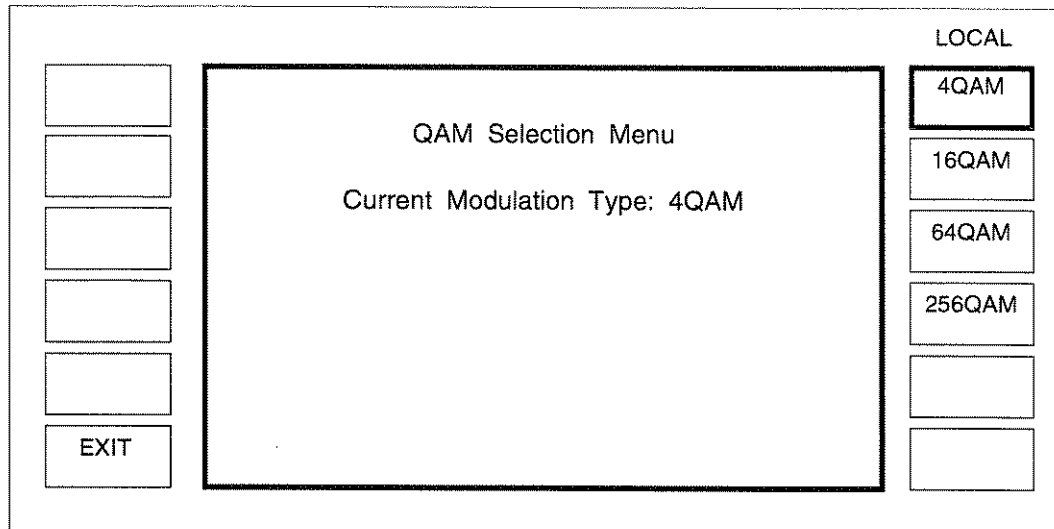

Fig. 3-1-25 Digital modulation: QAM selection menu with 4QAM selected

Pressing any of the keys in the menu makes [4QAM], [16QAM], [64QAM] or [256QAM] the current modulation type and selects a modulation system consisting of 2, 4, 6 or 8 bits per symbol organised as square constellations.

Menu exit

Pressing [EXIT] returns to the Digital Modulation Type Selection menu (Fig. 3-1-24).

PSK selection menu

For phase shift keying pressing [PSK] displays the PSK Selection Menu shown in Fig. 3-1-26.

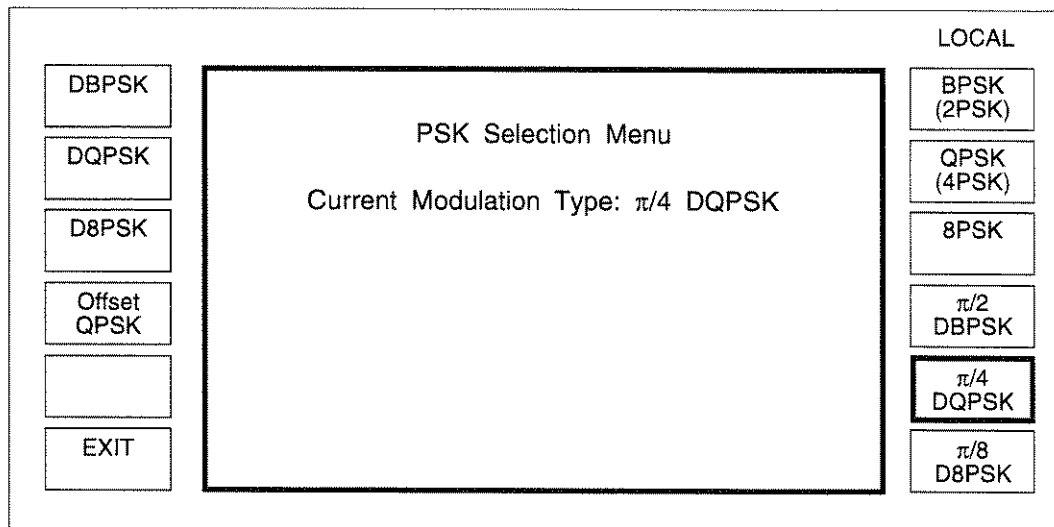

Fig. 3-1-26 Digital modulation: PSK selection menu with phase offset $\pi/4$ differential QPSK selected

The modulation types that can be generated are PSK, differential PSK, phase offset differential PSK and time offset QPSK. Pressing any of the keys makes this selection the current modulation type and selects a modulation system consisting of 1, 2 or 3 bits per symbol.

FSK selection menu

For frequency shift keying pressing *[FSK]* displays the *FSK Selection Menu* shown in Fig. 3-1-27.

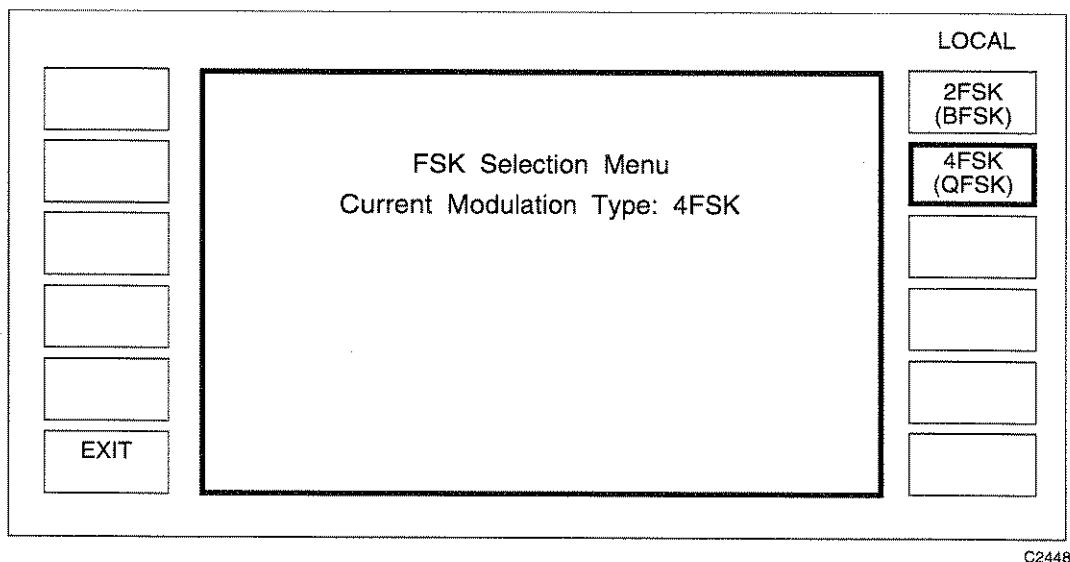

Fig. 3-1-27 Digital modulation: FSK selection menu with 4FSK selected

Pressing *[2FSK]* or *[4FSK]* respectively selects 2FSK or 4FSK as the current modulation type and selects a modulation system consisting of 1 or 2 bits per symbol.

Menu exit

Pressing *[EXIT]* returns to the *Digital Modulation Type Selection* menu (Fig. 3-1-24).

Symbol rate setting

The symbol source can either be internally generated or sourced externally from the rear panel AUXILIARY IN/OUT connector. To set the source rate, press *[Symbol Rate]*, enter a rate using the numeric key pad and terminate with the *[kHz]* or *[Hz]* key. If an out of range value is entered the appropriate upper or lower limit will be automatically selected. Note that for an external source, the symbol rate supplied must be within 2% of the entered rate to maintain modulation accuracy.

Data source, symbol clock and polarity selection are made using the *Data/Timing Control Menu* (see Fig. 3-1-30 below).

Filter selection

To select the channel filter type between Root Raised Cosine, Raised Cosine and Gaussian, press [Filter Type] which displays the [Channel Filter Selection] menu (see Fig. 3-1-28 below).

Channel Filter Selection

Root Raised Cosine

Raised Cosine

Gaussian/Bessell

LOCAL

Root Nyquist

Nyquist

Gaussian

EXIT

C1631

Fig. 3-1-28 Digital modulation: Channel filter selection menu

Pressing [Root Nyquist], [Nyquist] or [Gaussian] respectively selects root raised cosine, raised cosine or gaussian/bessel as the current RF channel filter.

Menu exit

Pressing [Exit] returns to the *Digital Modulation System Menu* (Fig. 3-1-11).

Filter α setting

When a Raised Cosine or Root Raised Cosine filter has been selected from the *Channel Filter Selection* menu, the α of the filter can be set. Press the [Filter Alpha] key, enter the numeric value of α and terminate with the [enter] key.

Filter band-pass 3 dB bandwidth setting

When a gaussian filter has been selected from the *Channel Filter Selection* menu, the band-pass 3 dB bandwidth of the filter can be set. Press the [Bandpass 3 dB BW] key, enter the band-pass 3 dB bandwidth point and terminate with either the [Hz] or [kHz] key.

Frequency deviation setting

When FSK modulation has been selected from the *FSK Selection Menu*, the frequency deviation of the modulation system can be set. Press the [Deviat'n] key, enter the frequency deviation value and terminate with either the [Hz] or [kHz] key.

Menu exit

Press [SIG GEN] to return to the *Sig Gen* menu where further selections may be made.

Parameter constraints

The modulation type selected has an effect on the setting of the symbol rate and on the selection of the channel filter in the following manner:

Modulation type	Symbol rate range	Channel filter selection
QAM	1.9 - 34.0 kHz	Nyquist
	1.9 - 34.0 kHz	Root Nyquist
	1.9 - 25.0 kHz	Gaussian
PSK	1.9 - 34.0 kHz	Nyquist
	1.9 - 34.0 kHz	Root Nyquist
	1.9 - 25.0 kHz	Gaussian
FSK	512 Hz - 25.0 kHz	Gaussian only
GMSK	512 Hz - 25.0 kHz	Gaussian only

The band-pass 3 dB bandwidth minimum and maximum limits are determined by the symbol rate setting. The minimum value is defined as 0.4 of the symbol rate (0.2 of the symbol rate as IQ baseband filter). The maximum value will lie in the range 11 to 17 kHz.

TEST TONES UTILITY

The test tones facility allows verification of the instrument performance by internally generating two audio sources with independent level and phase adjustment and a DC offset control. The facility can also be used for generating SSB signals.

Selecting Test Tones from the *Digital Modulation Type Selection* menu (Fig. 3-1-24), causes the *Digital Modulation System Menu* to be displayed as shown in Fig. 3-1-29.

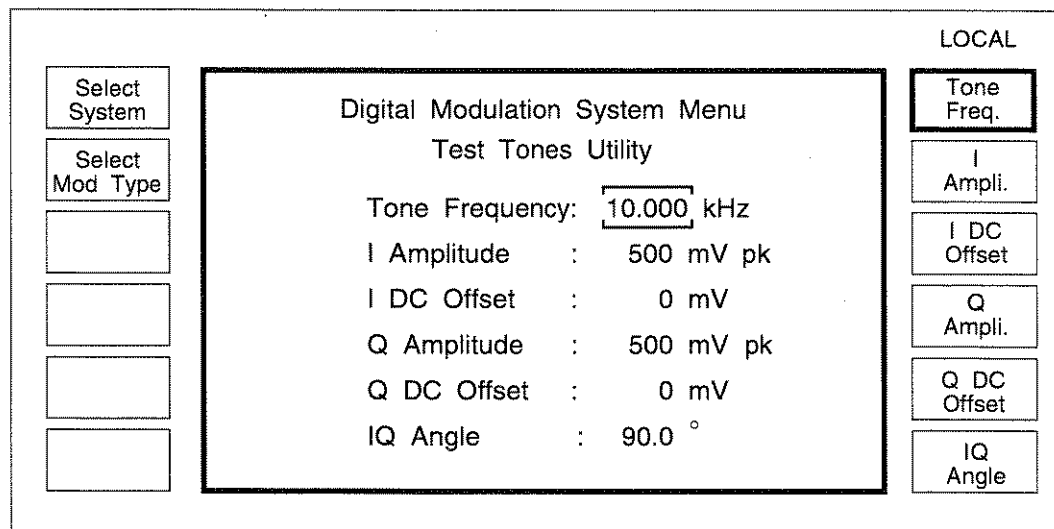

C1630

Fig. 3-1-29 Digital modulation: Modulation system menu with test tones selected

Test tones operation

With IQ O/P Enable selected from the *Digital Modulation Configuration* menu (see Fig. 3-1-42 below), the test tones generated at the I and Q IN/OUT sockets are sine waves at a selected frequency and phase angle. If the test tones are set to generate equal amplitude signals separated by 90° or 270° the RF output will be an SSB signal. Adjusting the DC offset will introduce carrier leak. The I and Q amplitudes and DC offsets can be individually set as follows:

To set the test tone frequency press [*Tone Freq.*] and enter a frequency up to 29 kHz to a resolution of 1 Hz.

To set the IQ angle, press [*IQ Angle*] and enter an angle in the range 0° to 360° to a resolution of 0.1°.

To set the I or Q amplitude, press either [*I Ampli.*] or [*Q Ampli.*] respectively and enter a voltage to a maximum of 1.6 V and a resolution of 1 mV.

To set the I or Q DC offset, press either [*I DC Offset*] or [*Q DC Offset*] respectively and enter a voltage to a maximum of 1.6 V and a resolution of 1 mV.

Menu exit

Press [*Select System*] or [*Select Mod Type*] to return to the respective menus. Press [SIG GEN] to return to the *Sig Gen* menu where further selections may be made.

DATA/TIMING

The *[Data/Timing]* key on the *Sig Gen* menu is used to select the modulating data source and to define the bit clock and symbol clock operation. Pressing the *[Data/Timing]* key causes the *Data/Timing Control Menu* shown in Fig. 3-1-30 to be displayed (this key is not available in test tone mode).

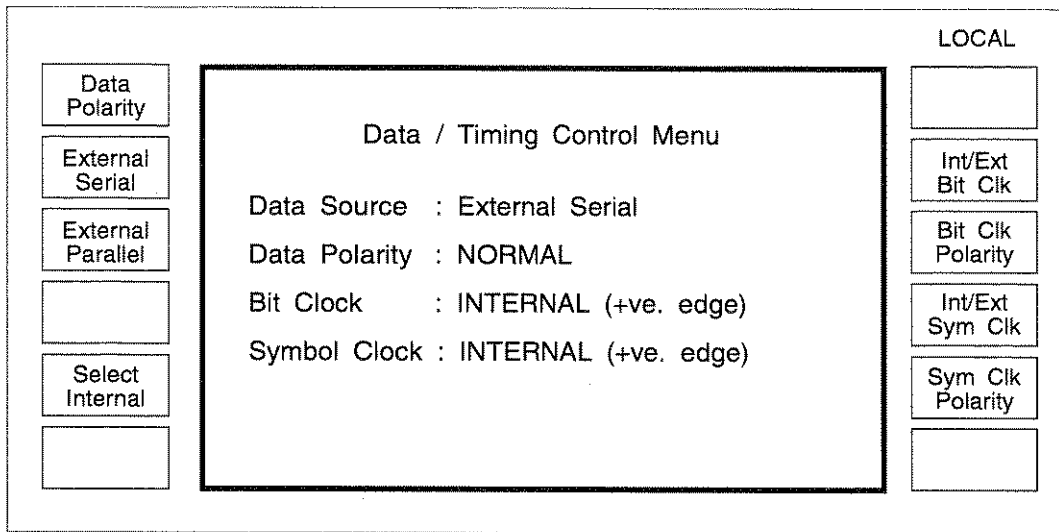

Fig. 3-1-30 Digital modulation: Data/Timing control menu

Data

Data input may be selected between external i.e. connected to the rear panel AUXILIARY IN/OUT connector, and internal i.e. generated by the instrument as follows:

For external data input select either serial or parallel data by pressing either the *[External Serial]* or *[External Parallel]* key. Note that the soft keys controlling the bit clock are suppressed for parallel data operation. For the modulation data contact assignments for the rear panel connector see Table 2-1.

To change the data polarity press the *[Data Polarity]* key which toggles between normal and inverse polarity.

For internal data generation press *[Select Internal]* which displays a further menu (see Fig. 3-1-31 below).

Note...

For details on how data is mapped on the RF carrier see 'Digital data mapping' below.

Timing

The clock timing sources can be selected between externally and internally derived. The signals are applied to, or are available, on the appropriate contact of the rear panel AUXILIARY IN/OUT connector. (For pin-out see 'Auxiliary I/O connector' in Chap. 2.)

Timing selection is as follows:

To select the symbol clock source for parallel operation press the *[Int/Ext Symbol Clk]* key to toggle between an external input and an internally generated source.

To change the symbol clock polarity press *[Sym Clk Polarity]* to toggle between positive and negative edge triggering.

For serial data operation, the bit clock source may be selected by pressing the *[Int/Ext Bit Clock]* to toggle between an external clock input and one being generated internally.

To change the bit clock polarity press *[Bit Clk Polarity]* to toggle between positive and negative edge triggering.

Menu exit

Press *[SIG GEN]* to return to the *Sig Gen* menu where further selections may be made.

Selecting internal data

Pressing *[Select Internal]* displays the *Internal Data Selection* menu shown in Fig. 3-1-31.

Internal Data Selection

Data Source: Pseudo Random

"n" value: 15 - -

[Permitted "n" values are: 2-7, 9, 10, 11, 15]

LOCAL

PRBS "n" Value

All 0's

All 1's

PRBS

EXIT

C0847

Fig. 3-1-31 Digital modulation: Internal data selection menu with PRBS selected

This menu enables the bit stream to be set to *[All 0's]*, *[All 1's]* or *[PRBS]*.

When pseudo random bit stream is selected, the length of the sequence can be entered. To do this, press the *[PRBS "n" Value]* key and enter an allowed value of n, then terminate by the *[enter]* key.

Menu exit

Pressing *[EXIT]* returns to the *Data/Timing Control Menu* (Fig. 3-1-30).

DIGITAL DATA MAPPING

The signal generator converts digital signals to the required modulation format mapped onto an I,Q diagram. Digital data is mapped for the modulation types selected from the *Digital Modulation Type Selection* menu (Fig. 3-1-24). Data mapping is defined as follows:

1. I is in phase with the carrier whereas Q is in quadrature with the carrier.
2. The Q-channel lags the I-channel by 90° .
3. An increase in frequency results in the rotation of a vector in a counter-clockwise direction.

PSK

For PSK the codes are mapped to specific points which are independent of the previous states. For all the forms of PSK detailed below the vectors lie on a circle but the amplitude of the signal will be non-constant between sampling points.

BPSK (2PSK)

The BPSK constellation is defined below and shown in Fig. 3-1-32.

Data	Vector point
0	P0
1	P1

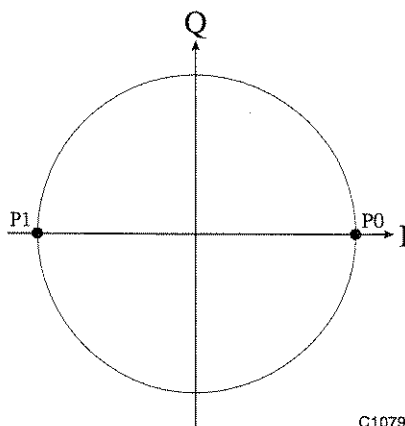

C1079

Fig. 3-1-32 BPSK constellation

QPSK (4PSK)

The QPSK constellation is defined below and shown in Fig. 3-1-33.

Data	Vector point
00	P0
01	P1
10	P2
11	P3

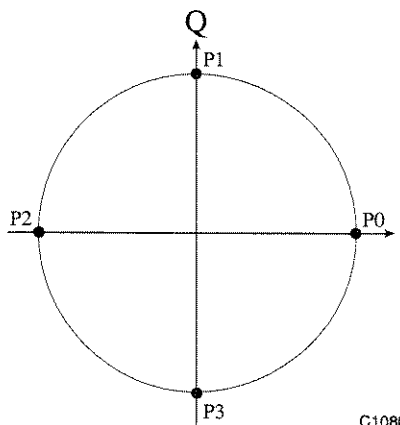

C1080

Fig. 3-1-33 QPSK constellation

8PSK

The 8PSK constellation is defined below and shown in Fig. 3-1-34.

Data	Vector point	Phase
000	P0	0°
001	P1	+45°
010	P2	+90°
011	P3	+135°
100	P4	180°
101	P5	-135°
110	P6	-90°
111	P7	-45°

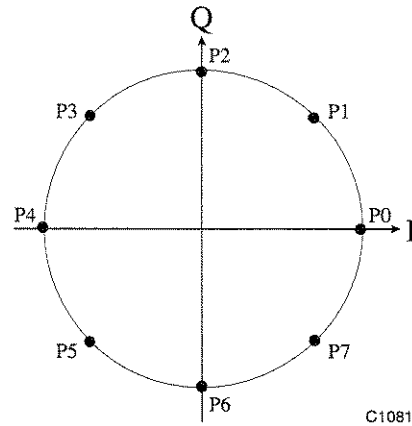

Fig. 3-1-34 8PSK constellation

Time offset QPSK

For time offset QPSK each data state is mapped to a specific point on the I,Q diagram. The time offset QPSK constellation is defined below and shown in figure 3-1-35.

Data	Vector point
00	P0
01	P1
10	P2
11	P3

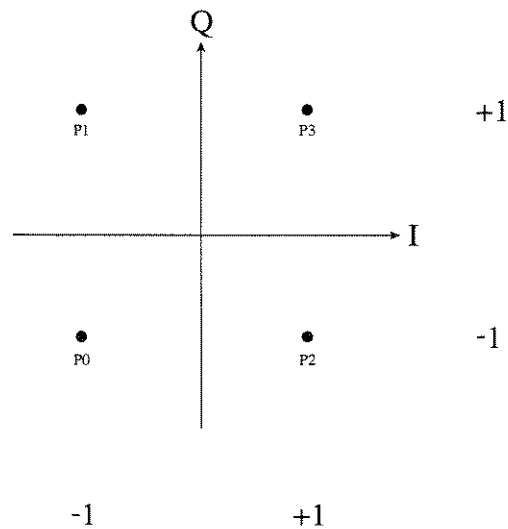

Fig. 3-1-35 Time offset QPSK constellation

Differential PSK

For differential PSK the I,Q diagram uses the previous bit as a reference phase (ie as the I axis) when deciding the next mapping point. In the case of differential BPSK a logical '0' results in a static phase while a logical '1' results in a continuous string of 180° phase changes.

Differential BPSK

Data	Phase change
------	--------------

0	0°
1	180°

The vector points are the same as for BPSK (Fig. 3-1-32).

Differential QPSK

Data	Phase change
------	--------------

00	0°
01	+90°
10	-90°
11	180°

The vector points are the same as for QPSK (Fig. 3-1-33).

Differential 8PSK

Data	Phase change
------	--------------

000	0°
001	+45°
010	+135°
011	+90°
100	-45°
101	-90°
110	180°
111	-135°

The vector points are the same as for 8PSK (Fig. 3-1-34).

Phase offset differential PSK

Phase offset differential PSK uses a $\pi/2^n$ phase shift between constellation points on the I,Q diagram where n is the number of bits per symbol. The phase of the previous state is used as the reference phase for the next state.

Phase offset $\pi/2$ differential BPSK

The phase offset $\pi/2$ differential BPSK constellation is defined below and shown in Fig. 3-1-36.

Data	Phase change	Example state changes
0	+90°	P0 → P1
1	-90°	P0 → P3

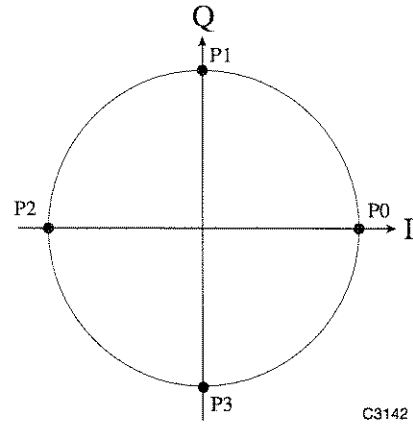

Fig. 3-1-36 Phase offset $\pi/2$ differential BPSK constellation

Phase offset $\pi/4$ differential QPSK

The phase offset $\pi/4$ differential QPSK constellation is defined below and shown in Fig. 3-1-37.

New data	Phase change	Example State changes
00	+45°	P0 → P1
01	+135°	P0 → P3
10	-45°	P0 → P7
11	-135°	P0 → P5

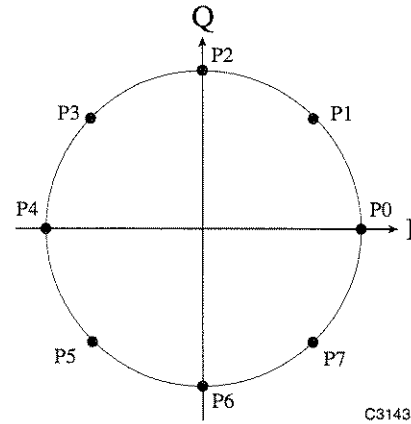

Fig. 3-1-37 Phase offset $\pi/4$ differential QPSK constellation

Phase offset $\pi/8$ differential 8PSK

The offset $\pi/8$ differential 8PSK constellation is defined below and shown in Fig. 3-1-38.

New data	Phase change	Example state changes
000	+22.5°	P0→P1
001	+67.5°	P0→P3
010	-22.5°	P0→P15
011	+112.5°	P0→P5
100	-67.5°	P0→P13
101	+157.5°	P0→P7
110	-112.5°	P0→P11
111	-157.5°	P0→P9

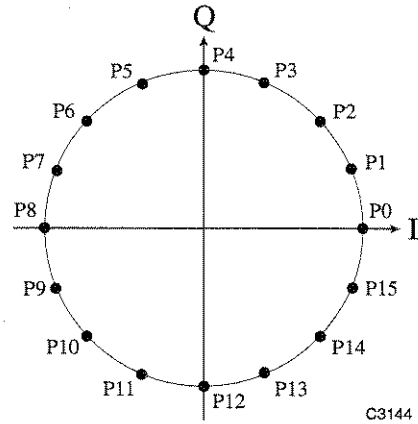

Fig. 3-1-38 $\pi/8$ differential 8PSK constellation

QAM

For QAM each data state is mapped to a specific point on the I,Q diagram. There are 4 levels of QAM allowed: 4QAM, 16QAM, 64QAM and 256QAM.

For each of the following state diagrams each state is labelled with a decimal number. The decimal number is the condition of the data applied to the AUXILIARY I/O connector e.g. for 16QAM state 14 is obtained with D3 to D0 set to 1110 respectively.

4QAM

The 4QAM constellation is shown in Fig. 3-1-39.

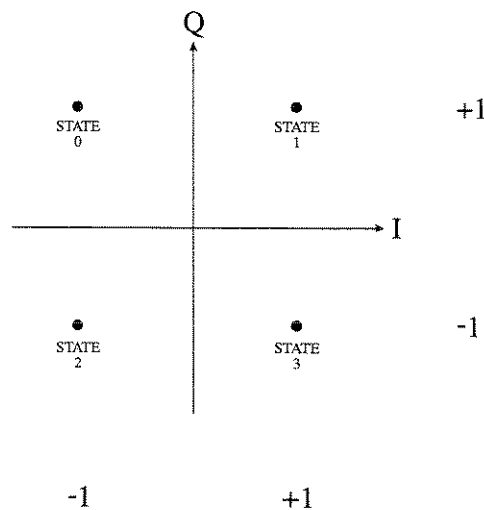
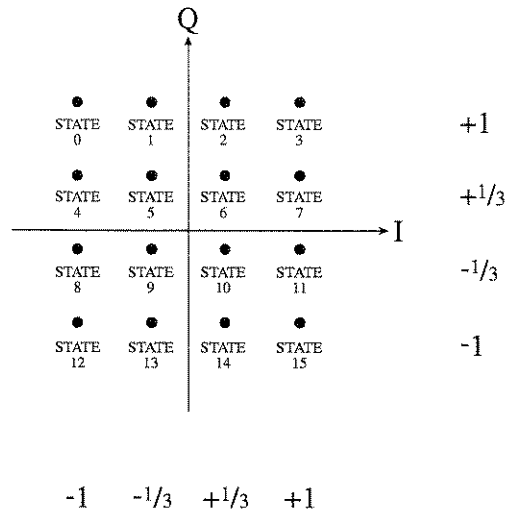

Fig. 3-1-39 4QAM constellation

16QAM

The 16QAM constellation is shown in Fig. 3-1-40.



C1355

Fig. 3-1-40 16QAM constellation

64QAM AND 256QAM

For these forms of QAM the vector diagram states are similar to 4QAM and 16QAM insofar as state 0 is always at the top left-hand corner of the diagram, and the intermediate vector values between 0 and +1 are derived as follows:

$$\text{1st value above 0} = \frac{1}{(\sqrt{n}-1)}$$

where n = the total number of states for the QAM constellation pattern.

and

$$\text{subsequent values} = 2 \times \frac{1}{(\sqrt{n}-1)} + \text{last value}$$

Negative values of I and Q are the same except for the sign.

FSK

The symbol mapping of the signal is as follows:

2FSK

Data	Nominal frequency
1	carrier + frequency deviation
0	carrier - frequency deviation

4FSK (Grey coded)

Data	Nominal frequency
10	carrier + frequency deviation
11	carrier + (frequency deviation/3)
01	carrier - (frequency deviation/3)
00	carrier - frequency deviation

MODULATION CONFIGURATION

The *Digital Modulation Configuration* menu is used for controlling the conversion of an IQ modulated IF to the required carrier frequency and for enabling the required inputs and outputs. A simplified block diagram of the system is shown in Fig. 3-1-41. To control these functions press the [ConFig.Select] key on the Sig Gen menu which causes the *Digital Modulation Configuration* menu shown in Fig. 3-1-42 to be displayed.

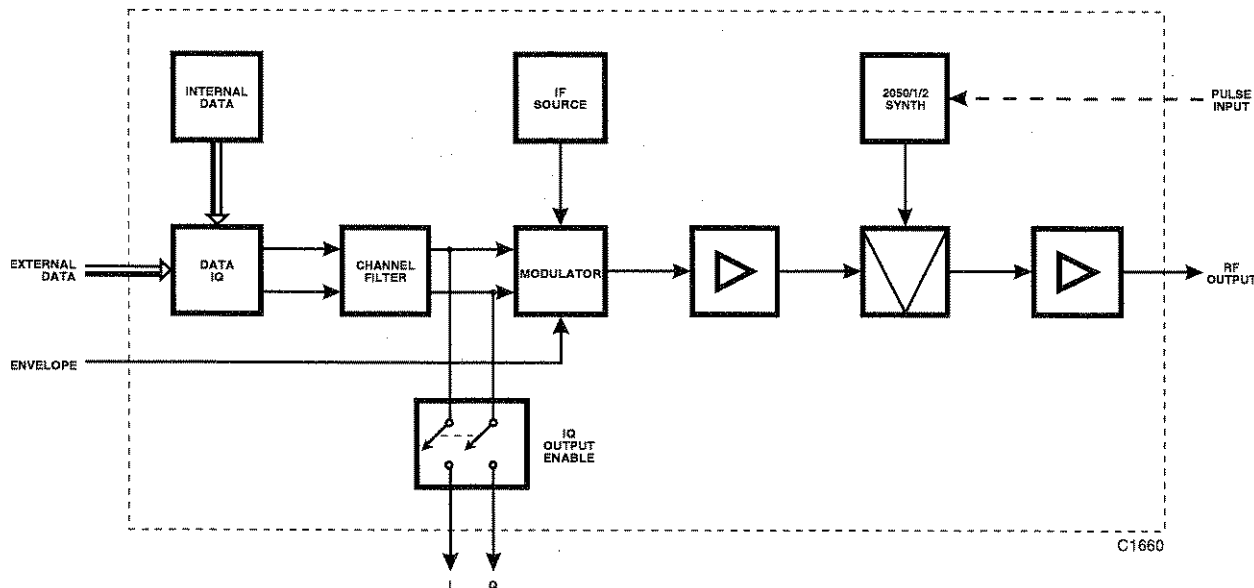

Fig. 3-1-41 Simplified block diagram: Digital mode with internal mixing

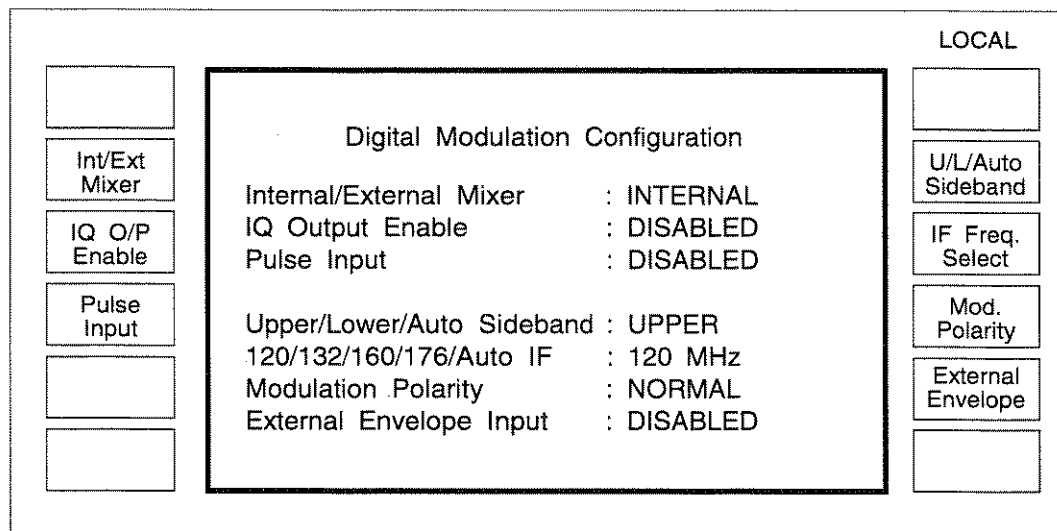

Fig. 3-1-42 Digital modulation: Modulation configuration menu

IQ output enable

The [IQ O/P Enable] key enables the I and Q outputs to be selected as on or off.

Mixer selection

Pressing the [Int/Ext Mixer] key toggles between internal and external mixer selection. When set to internal mixer the configuration is as shown in Fig. 3-1-41 where an internal mixer is used to convert the IQ modulated IF to the required carrier frequency. When external mixer is selected the normal signal generator output is made available on the RF OUTPUT connector and the configuration is as shown in Fig. 3-1-43. The output can then be used as a local oscillator for external frequency multiplication and mixing with the IF to produce higher frequencies than those available internally.

Note...

When set to internal mixer the IF output is disabled. When set to external mixer the IF output is enabled and appears at the rear panel IF OUTPUT connector.

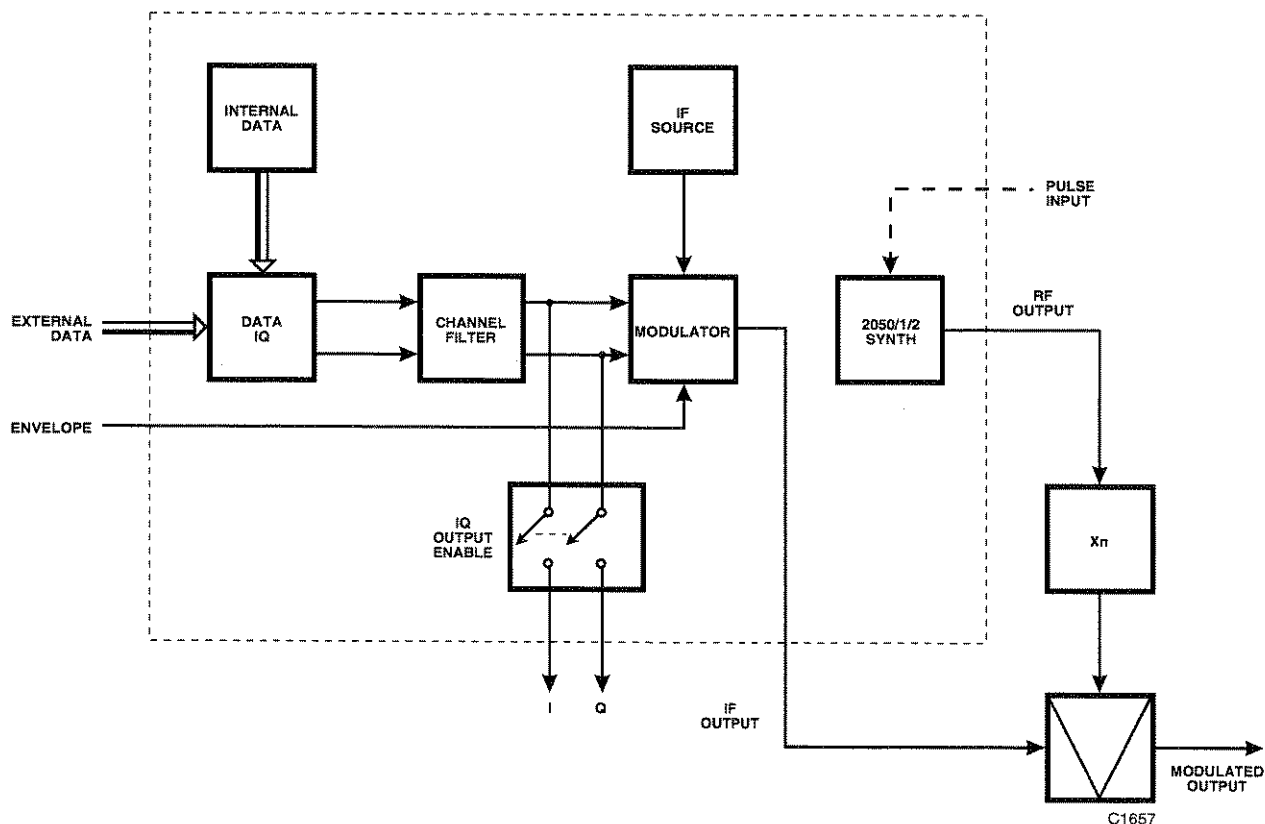

Fig. 3-1-43 Simplified block diagram: Digital mode with external mixing

Pulse input selection (applies if Option 002 fitted)

Pressing the [Pulse Input] key enables and disables the pulse input. With pulse input enabled, applying 5 V to the PULSE INPUT connector turns the RF carrier on and 0 V turns the carrier off. This facility enables the RF output to be rapidly turned on or off.

Sideband and IF selection

The *Digital Modulation Configuration* menu is used to determine which of four IFs is used and whether the selected carrier frequency corresponds to the upper or lower sideband frequency in the mixing process. Automatic selection is also available which minimises the effects of any mixing products resulting from the frequency conversion process.

To select the required sideband, repetitively press the *[U/L/Auto Sideband]* key which cycles through the selections *UPPER*, *LOWER* and *AUTO SIDEBAND* as shown by the display. When *AUTO* is selected, the selection is displayed in brackets. Manual settings which are unacceptable (depending on carrier frequency) are disallowed and an error message is displayed.

To select the required IF, repetitively press the *[IF Freq Select]* key which cycles through the selections *120 MHz*, *132 MHz*, *160 MHz*, *176 MHz* and *AUTO IF* as shown by the display. When *AUTO* is selected, the automatically chosen optimum IF is additionally displayed in brackets.

Modulation polarity

To change the modulation polarity press the *[Mod. Polarity]* key which toggles between *NORMAL* modulation sense and *INVERSE* modulation sense. *INVERSE* can be used to simulate IF signals where the modulation sense has been reversed in frequency converting the input RF signal.

External envelope

Pressing the *[External Envelope]* key toggles between enabling and disabling an external envelope input connected to the front panel ENVELOPE IN connector. The RF level output can be linearly controlled, 0 V producing no output and +1 V producing the set RF output.

Note...

When enabled, Rayleigh and Rician fading cannot be simulated.

Menu exit

Press *[SIG GEN]* to return to the *Sig Gen* menu where further selections may be made.

MODULATION FADING

The signal generator is able to simulate the effects of fading in a transmission system. Pressing the *[Fading Control]* key on the *Sig Gen* menu causes the *Digital Modulation Fading Control* menu shown in Fig. 3-1-44 to be displayed.

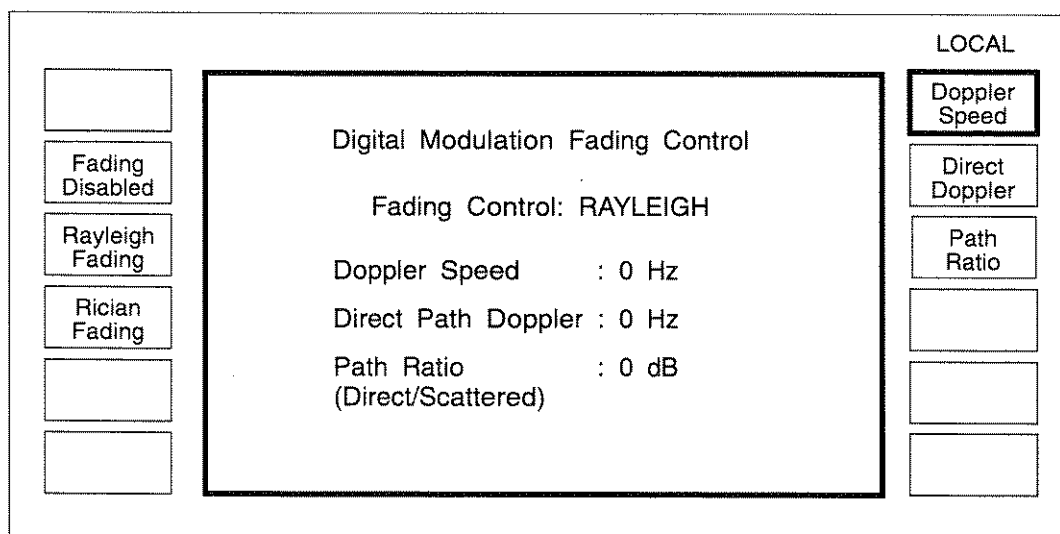

Fig. 3-1-44 Digital modulation: Fading control menu showing Rayleigh fading selected

Select between the two types of fading by pressing the *[Rayleigh Fading]* or *[Rician Fading]* key.

Doppler speed for Rayleigh fading and the scattered path for Rician fading can be entered using the *[Doppler Speed]* key.

To set the direct/scattered path ratio for Rician fading, press the *[Path Ratio]* key, enter the path ratio in dB (positive or negative) and terminate the entry with the *[dB]* key. The direct path doppler speed for Rician fading can be entered using the *[Direct Doppler]* key. The entered value must be within a factor of 2 of the scattered path doppler.

When not required fading can be disabled using the *[Fading Disabled]* key.

Note that when Rayleigh fading is enabled the direct path doppler and the path ratio settings are ignored. Also fading is not selectable in GSM or OQPSK modes.

Menu exit

Press *[SIG GEN]* to return to the *Sig Gen* menu where further selections may be made.

IQ MODULATOR ERRORS

The *[IQ Errors]* key on the *Sig Gen* menu can be used to introduce deliberate modulation errors. Pressing the *[IQ Errors]* key causes the *IQ Modulator Errors* menu shown in Fig. 3-1-45 to be displayed.

LOCAL

Enable/Disable	IQ Modulator Errors Modulator Errors: ENABLED IQ Skew : 0.0° OFF IQ Gain Imbalance : 0.0 dB OFF Carrier Leak : 0.0 % OFF	IQ Skew
Error ON/OFF		IQ Gain
		Carrier Leak

C1531

Fig. 3-1-45 Digital modulation: IQ modulator errors menu

Each of the three modulation errors, IQ skew error, IQ gain error and carrier leak error may be individually set as follows:

To set the IQ skew error, press the *[IQ Skew]* key and enter the error in the range 0° to 20° to a resolution of 0.1°. Terminate the entry with the *[enter]* key.

To set the IQ gain imbalance error, press the *[IQ Gain]* key and enter the error in the range 0 to 10 dB to a resolution of 0.1 dB.

To set the carrier leak error, press the [*Carrier Leak*] key and enter the error in the range 0 to 10% to a resolution of 0.1%.

After making any of the above three selections, pressing the [*Error ON/OFF*] key toggles between the on and off states to select any combination of errors.

Pressing the [*Enable/Disable*] key allows all the errors that have been set to be toggled on or off.

Note that modulation errors cannot be introduced when operating in GSM or OQPSK modes.

Menu exit

Press [SIG GEN] to return to the *Sig Gen* menu where further selections may be made.



VECTOR MODULATION MODE

VECTOR MODULATION

In vector mode operation the instrument provides IQ modulation of the carrier from an external source. The RF level can be varied by applying an envelope control voltage. Fading errors can be simulated. Provision is also made for using an external mixer to generate a modulated carrier at a higher frequency than can be provided by the instrument.

To select the Vector control function press the [Vector] key on the *Modulation Mode Selection Menu* (see Fig. 3-1-8), followed by [SIG GEN]. This causes the *Sig Gen* menu shown in Fig. 3-1-46 to be displayed.

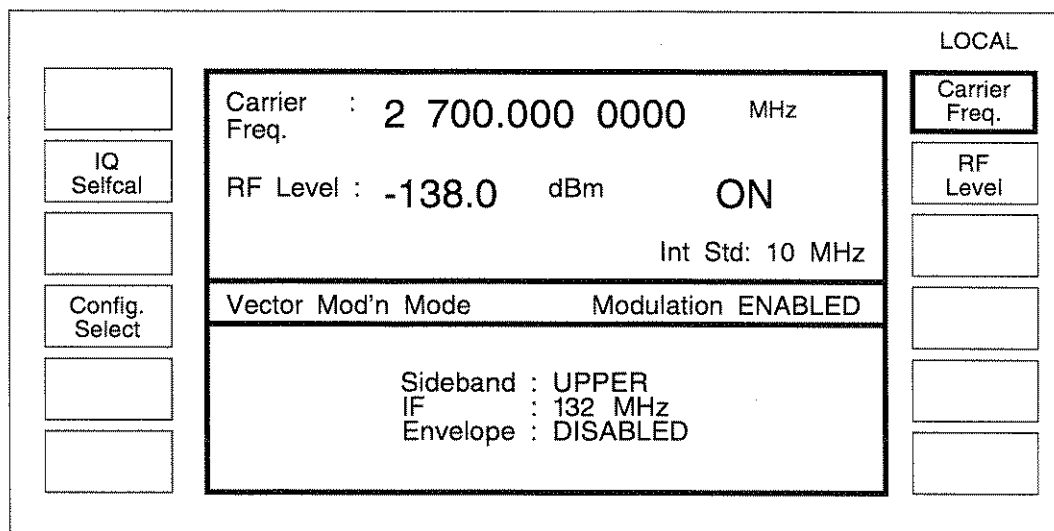

C1627

Fig. 3-1-46 Sig Gen menu in vector modulation mode

Setting the output carrier

In vector modulation mode the carrier output frequency and level are set by pressing the [Carrier Freq.] and [RF Level] keys respectively and entering the values in the normal way.

Self-calibration

To achieve the high precision of the complex modulation the 2050 series Signal Generators have an IQ self-calibration feature which automatically adjusts the modulator for optimum performance minimising vector errors. The instrument generates a warning message at the top of the screen when an IQ self-calibration is advisable. This will occur 30 minutes after power-on and thereafter at 3 hour intervals.

To perform a self-calibration press [IQ Selfcal]. The calibration process is automatic and during operation the message *IQ MODULATOR CALIBRATION IN PROGRESS PLEASE WAIT ...* appears.

MODULATION CONFIGURATION

The *Vector Modulation Configuration* menu is used for converting an IQ modulated IF to the required carrier frequency and for enabling the required inputs and outputs. A simplified block diagram of the system is shown in Fig. 3-1-47. To control these functions press the [ConFig.Select] key on the Sig Gen menu which causes the *Vector Modulation Configuration* menu shown in Fig. 3-1-48 to be displayed.

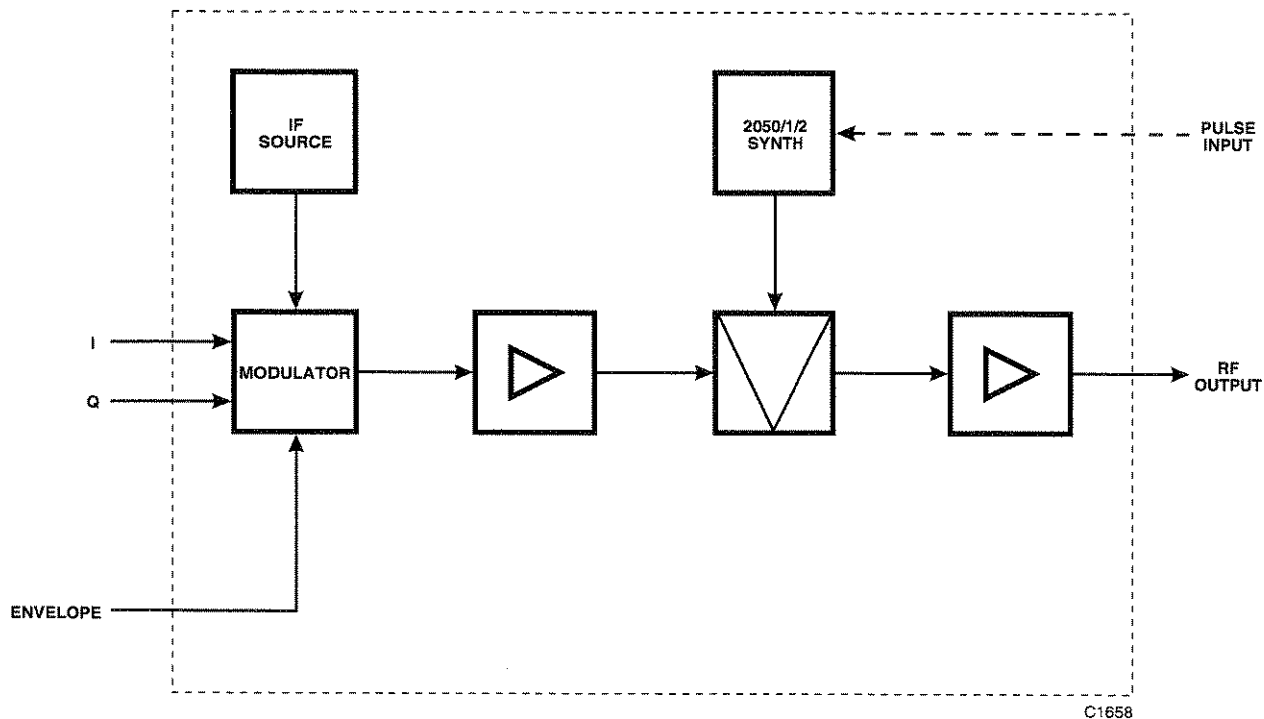

Fig. 3-1-47 Simplified block diagram: Vector mode with internal mixing

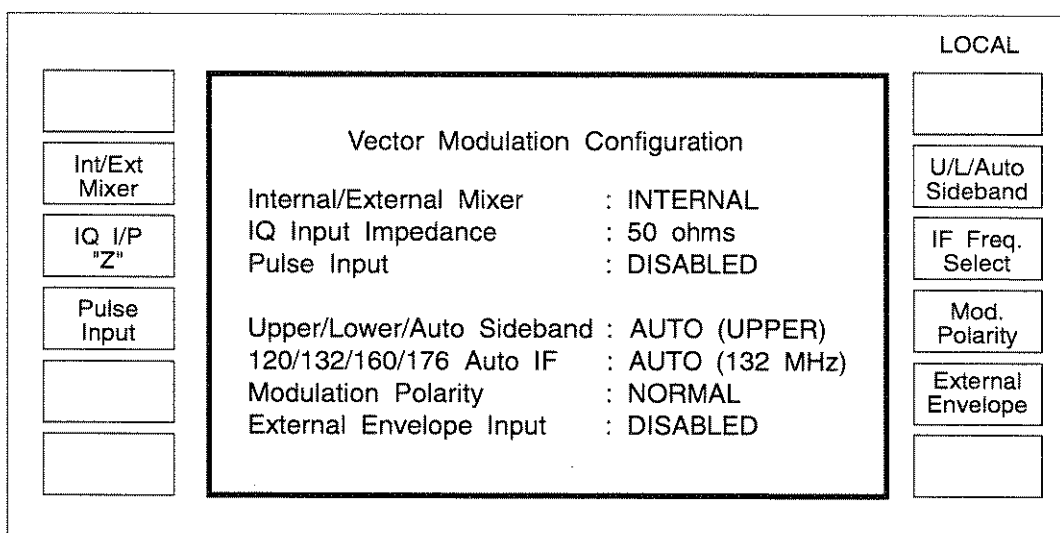

Fig. 3-1-48 Vector modulation: Modulation configuration menu with internal mixer selected

Mixer selection

Pressing the *[Int/Ext Mixer]* key toggles between internal and external mixer selection. When set to internal mixer the configuration is as shown in Fig. 3-1-47 where an internal mixer is used to convert the IQ modulated IF to the required carrier frequency. When external mixer is selected the normal signal generator output is made available on the RF OUTPUT connector and the configuration is as shown in Fig. 3-1-49. The output can then be used as a local oscillator for external frequency multiplication and mixing with the IF to produce higher frequencies than those available internally.

Note...

When set to internal mixer the IF output is disabled. When set to external mixer the IF output is enabled and appears at the rear panel IF OUTPUT connector.

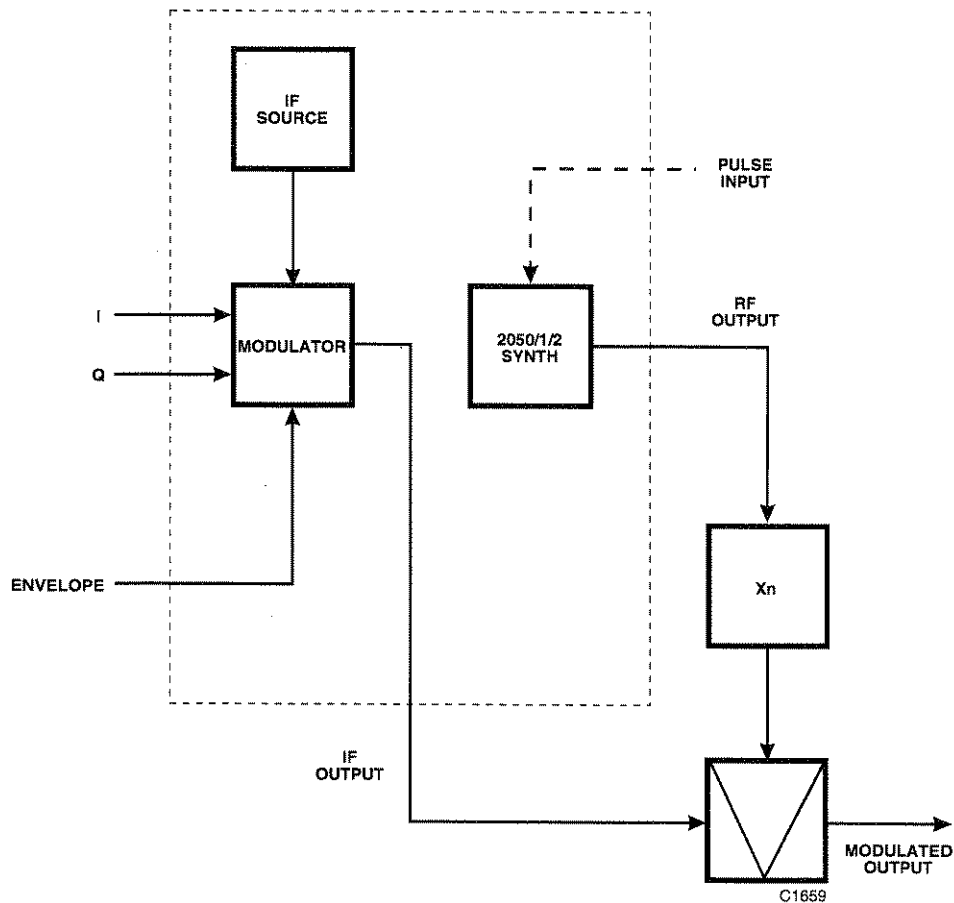

Fig. 3-1-49 Simplified block diagram: Vector mode with external mixing

IQ input impedance selection

The I and Q connector input impedances can be selected between 50 Ω and 300 Ω by pressing the *[IQ I/P "Z"]* key. The 300 Ω setting is provided for use with lower power sources such as A/D converters or operational amplifiers.

Pulse input selection (applies if Option 002 fitted)

Pressing the [*Pulse Input*] key enables and disables the pulse input. With pulse input enabled, applying 5 V to the PULSE INPUT connector turns the RF carrier on and 0 V turns the carrier off. This facility enables the RF output to be rapidly turned on or off.

Sideband and IF selection

The *Vector Modulation Configuration* menu is used to determine which of four IFs is used and whether the selected carrier frequency corresponds to the upper or lower sideband frequency in the mixing process. Automatic selection is also available which minimises the effects of any mixing products resulting from the frequency conversion process.

To select the required sideband, repetitively press the [*U/L/Auto Sideband*] key which cycles through the selections *UPPER*, *LOWER* and *AUTO SIDEBAND* as shown by the display. When *AUTO* is selected, the selection is displayed in brackets. Manual settings which are unacceptable (depending on carrier frequency) are disallowed and an error message is displayed.

To select the required IF, repetitively press the [*IF Freq Select*] key which cycles through the selections *120 MHz*, *132 MHz*, *160 MHz*, *176 MHz* and *AUTO IF* as shown by the display. When *AUTO* is selected, the automatically chosen optimum IF is additionally displayed in brackets.

Modulation polarity

To change the modulation polarity press the [*Mod. Polarity*] key which toggles between *NORMAL* modulation sense and *INVERSE* modulation sense. *INVERSE* can be used to simulate IF signals where the modulation sense has been reversed in frequency converting the input RF signal (in effect this exchanges the I and Q inputs).

External envelope

Pressing the [*External Envelope*] key toggles between enabling and disabling an external envelope input connected to the front panel ENVELOPE IN connector. But note that when enabled, Rayleigh and Rician fading cannot be simulated. The level is linearly controlled with 0 V producing no output and +1 V producing the set RF output.

Menu exit

Press [SIG GEN] to return to the *Sig Gen* menu where further selections may be made.

MODULATION FADING

The signal generator is able to simulate the effects of fading in a transmission system. Pressing the *[Fading Control]* key on the *Sig Gen* menu causes the *Vector Modulation Fading Control* menu shown in Fig. 3-1-50 to be displayed.

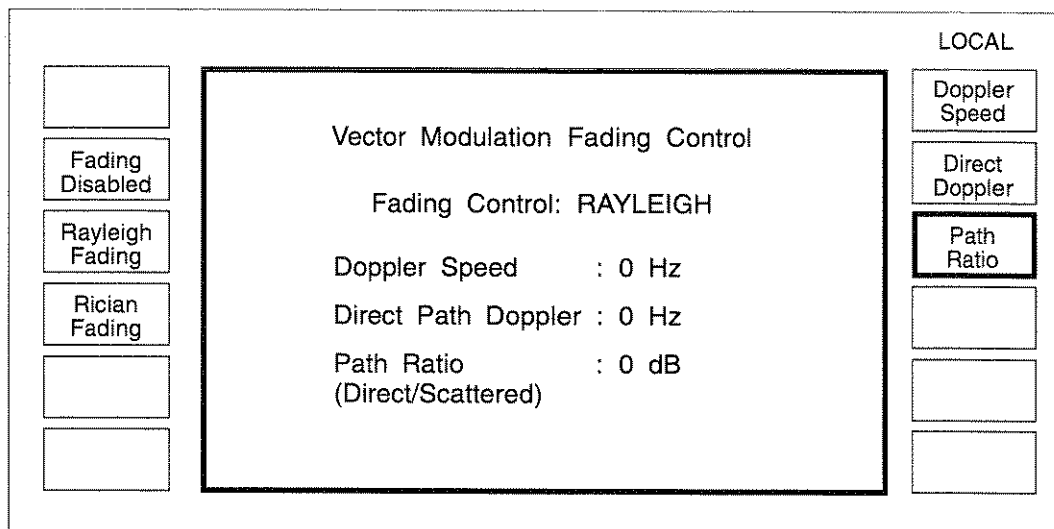

Fig. 3-1-50 Vector modulation: Fading control menu showing Rayleigh fading selected

Select between the two types of fading by pressing the *[Rayleigh Fading]* or *[Rician Fading]* key.

Doppler speed for Rayleigh fading and the scattered path for Rician fading can be entered using the *[Doppler Speed]* key.

To set the direct/scattered path ratio for Rician fading, press the *[Path Ratio]* key, enter the path ratio in dB (positive or negative) and terminate the entry with the *[dB]* key. The direct path doppler speed for Rician fading can be entered using the *[Direct Doppler]* key. The entered value must be within a factor of 2 of the scattered path doppler.

When not required the fading may be disabled using the *[Fading Disabled]* key.

Notes...

When Rayleigh fading is enabled the direct path doppler and the path ratio settings are ignored.

When fading is enabled the DCFM control of the main instrument synthesizer is used, hence when first enabled, or during an IQ selfcal, a nulling operation occurs. This ensures accurate carrier frequency output. The legend:

*** DCFM NULLING ***

appears briefly on the display.

Menu exit

Press *[SIG GEN]* to return to the *Sig Gen* menu where further selections may be made.

ANALOG MODULATION MODE

ANALOG MODULATION

The carrier can be frequency, amplitude, or phase modulated, with pulse modulation as an option. The internal modulation oscillator has a frequency range of 0.1 Hz to 500 kHz, with a resolution of 0.1 Hz.

To select the Analog control function press one of the [Single], [Dual], [Comp] or [Dual Comp] keys on the *Modulation Mode Selecton Menu* (see Fig. 3-1-8), followed by [SIG GEN]. This causes the *Sig Gen* menu similar to that shown in Fig. 3-1-51 to be displayed.

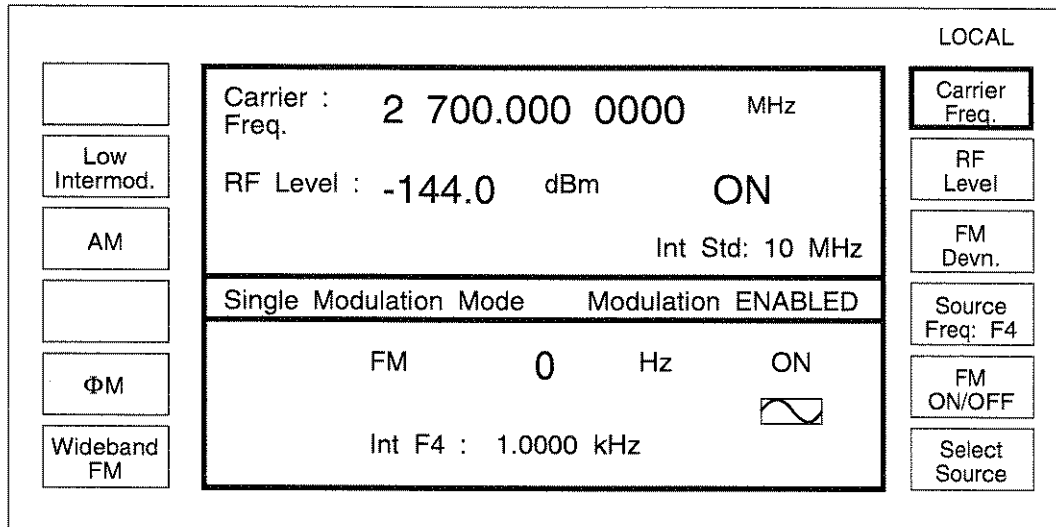

C0482

Fig. 3-1-51 Sig Gen menu - default display for 2051

Selecting the modulation

The type of analog modulation required, AM, FM, Φ M, wideband and optional pulse modulation can be selected by soft keys at the *Sig Gen* menu. Four analog modulation modes are available, see 'Modulation mode selection' above.

Modulation ON/OFF

[MOD ON-OFF] switches all modulation *ON* or *OFF* and the condition is indicated in the centre of the main display, e.g:

Modulation DISABLED

Modulation is also controlled by a soft key which turns the selected modulation on and off. For modulation to appear on the carrier, modulation must be both enabled with the [MOD ON-OFF] hard key and turned on via the soft key. In single modulation modes the [MOD ON-OFF] key and the [FM ON/OFF], [AM ON/OFF], [Φ M ON/OFF] keys appear to carry out the same function, but the action is different, particularly in the FM mode. The [FM ON/OFF] etc. soft keys only reduce the modulation to zero whereas the [MOD ON-OFF] key completely disables the modulation system so that the instrument reverts to a carrier frequency generator.

Selecting amplitude modulation

- (1) At the *Sig Gen* menu, press *[AM]*, the *[AM Depth]* box is now highlighted.
- (2) Enter the required modulation depth via the numerical key pad and terminate with the *[%]* key. If the modulation depth requested exceeds 99.9%, the depth is reset to the maximum value available and the message:

ERROR 56: AM Outside Limits

is displayed at the top of the screen.

- (3) Switch the AM ON or OFF by pressing *[AM ON/OFF]*. The AM information is displayed in the lower half of the screen.

Selecting frequency modulation

- (1) At the *Sig Gen* menu, press *[FM]*, the *[FM Devn.]* box will be highlighted.
- (2) Enter the FM deviation value via the numerical key pad and terminate it with *[Hz]*, *[kHz]* or *[MHz]*.
- (3) Switch the FM ON or OFF via *[FM ON/OFF]*. The FM information is displayed in the lower half of the screen.

Selecting phase modulation

- (1) At the *Sig Gen* menu, press *[ΦM]*. The *[ΦM Devn.]* box will be highlighted.
- (2) Enter the phase modulation deviation value via the numeric key pad and terminate it with the *[rad]* key.
- (3) Switch the ΦM ON or OFF via the *[ΦM ON/OFF]* key. The ΦM information is displayed in the lower half of the screen.

Selecting wideband frequency modulation

- (1) At the *Sig Gen* menu, press *[Wideband FM]*. The *[Wideband FM]* box will be highlighted.
- (2) The value can be changed via the key pad and frequency terminator key. To preserve the widest bandwidth, the control of the wideband FM is carried out in a series of fixed steps and the signal generator automatically displays the calculated fixed step which is closest to the keyed in value. Applying a 1 V RMS sine wave to the rear panel WIDE BAND FM IN socket will produce the indicated deviation.

- (3) Pressing [*AC/DC Coupling*] changes the coupling from AC to DC and vice versa. When the input is DC coupled, small frequency offsets can be reduced by using the nulling facility. Nulling can be effected by pressing [*DCFM Nulling*]. The legend:

*** *DCFM NULLING* ***

appears briefly on the display.

Note...

The [↑] and [↓] keys and the control knob do not operate for wideband FM.

CAUTION

The WBFM socket input impedance is 50 Ω. The DC component of any applied voltage must not exceed 5 V.

Modulation source frequency

- (1) At the *Sig Gen* menu press [*Source Freq.*].
- (2) Enter the required source frequency and terminate the entry with [Hz], [kHz] or [MHz].

Note...

When the modulation source is operating as a continuous signalling tone the [*Source Freq.*] legend is replaced with the [*Tone Number*]. Pressing the key allows a new tone number to be entered.

Source selection - internal

The modulation source may be selected by pressing [*Select Source*]. Sources may be internal or external. If the currently selected source is internal, the *Internal Source Selection Menu* is displayed, giving a choice of six frequencies, F1-F6, see Fig. 3-1-52. The frequency assigned to the highlighted F number may be changed by the numerical key pad and terminated with [Hz], [kHz], [MHz] or [GHz]. Soft keys allow the selection of either a sine or triangular waveform. The selection of sub-audible continuous tones can be achieved by pressing [*CTCSS*], see 'SIGNALLING'. Pressing [*Mod. Src Phase*] displays the *LF Source Phase Control* menu, see Fig. 3-1-53. The LF source phase angle can be varied from -180° to +180°. The pictograms at the end of each line show a symbolic sine wave when a source is selected. This changes to a triangular wave if [*Triangle Wave*] is selected or a square wave if [*Square Wave*] is selected. These symbols also appear on the main menu. A horizontal bar is shown when a source is not selected or is not available.

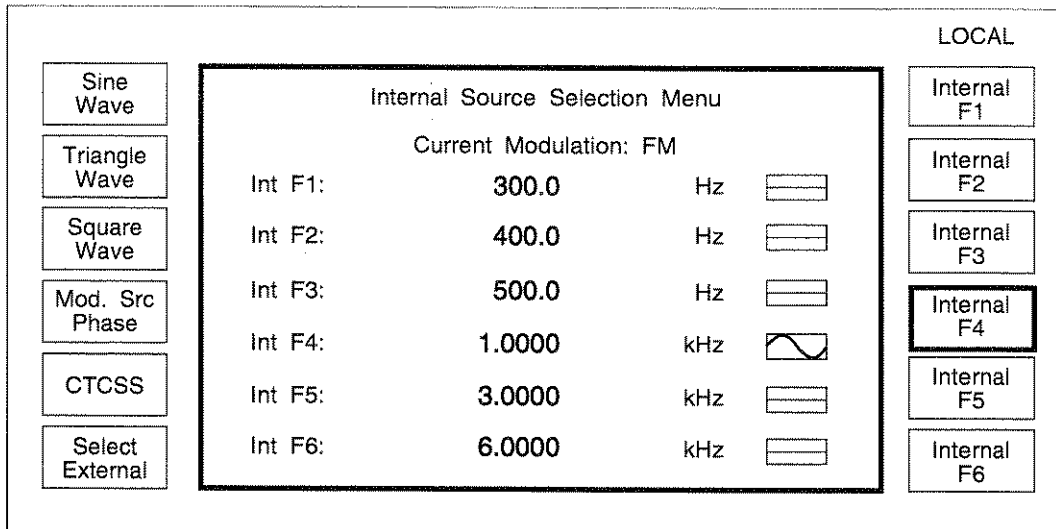

C1887

Fig. 3-1-52 Internal source selection menu

LF phase

When an internal source has been selected, its phase relative to the second modulation oscillator (if fitted) can be changed by pressing [Mod. Src Phase] and entering the required value. Where two internal modulation frequencies are active, the starting phase difference between the two signals can be set up and the phase angle is referred to the currently selected oscillator.

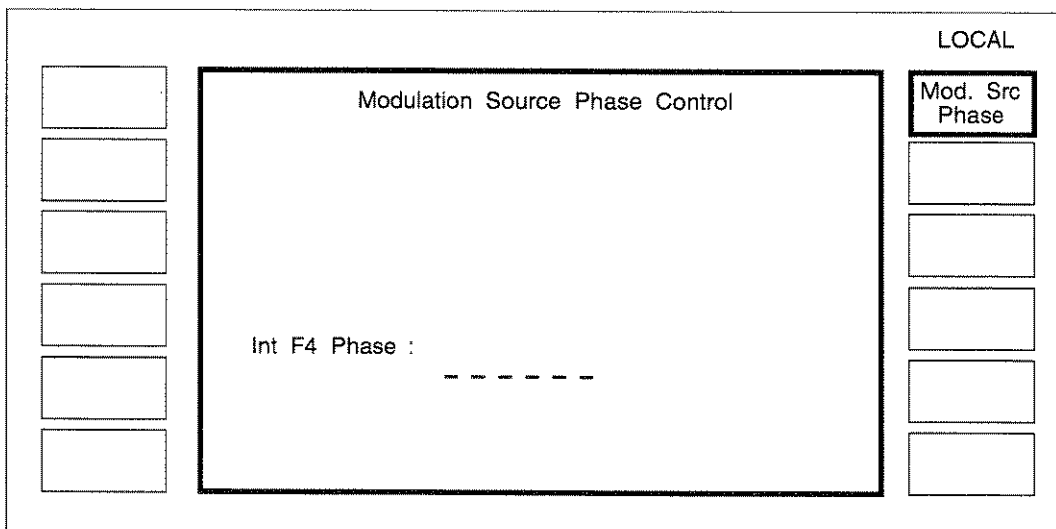

C1888

Fig. 3-1-53 LF phase control

Source selection - external

An external source may be selected by pressing [*Select External*]. The *External Source Selection Menu* is then displayed on the screen (This menu is displayed immediately when pressing [*Select Source*] if the currently selected source is external). This menu allows the choice of two input sockets EXT MOD 1 INPUT and EXT MOD 2 INPUT and AC, ALC, or DC coupling by pressing the appropriate soft key. The pictograms at the end of each line show a symbolic arbitrary waveform when an external source is selected. This symbol also appears on the main menu. A horizontal bar is shown when a source is not selected or is not available. When the input is DC coupled, small frequency offsets can be reduced by using the nulling facility. Nulling can be effected by pressing [*DCFM Nulling*].

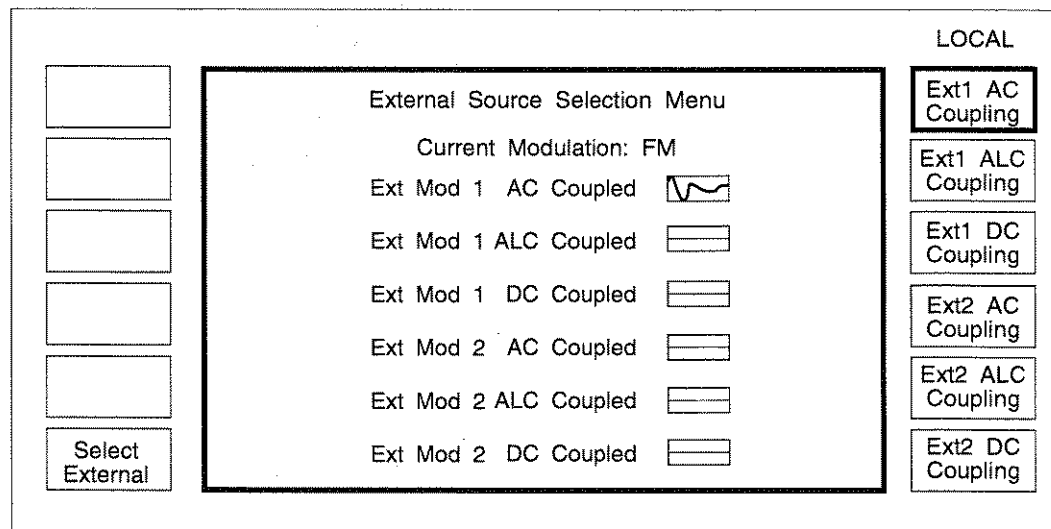

C0007

Fig. 3-1-54 External source selection menu

MODULATION ALC

The automatic levelling control (ALC) is used in conjunction with an external source and can be disabled when not required. To enable the ALC, proceed as follows:

- (1) At the *Sig Gen* menu, press [*Select Source*]. The display will show the *Internal* or *External Source Selection Menu* (Fig. 3-1-52 or Fig. 3-1-54).
- (2) If necessary press [*Select External*] to obtain the *External Source Selection Menu* (Fig. 3-1-54).
- (3) Select the required external source from the options shown, e.g. [*Ext 1 ALC Coupling*] or [*Ext 2 ALC Coupling*]. The pictogram at the end of each line will change from a horizontal line to an arbitrary waveform symbol when the source is selected.
- (4) Return to the *Sig Gen* menu by pressing [SIG GEN]. The legend *Ext Mod 1* (or *2*) *ALC coupled* appears at the bottom of the display.
- (5) Apply a signal to the EXT MOD 1 or EXT MOD 2 input socket and vary the level. If the input applied to the external modulation socket is outside the ALC range (at least 0.7 to 1.4 V RMS) *HI LO* will be indicated and an error message will be displayed at the top of the screen. If the level is within the required range, the arbitrary waveform symbol will appear alongside the modulation value.

PULSE MODULATION

(applies if Option 002 is fitted)

Enabling the pulse modulation disables the RF ALC system which is used to control the output level from the generator. The signal generator sets the requested RF output level using a digitally derived control signal whose level is equivalent to that which would be generated by the RF ALC system.

The calibration of the RF level can be set up to work in two possible ways. The normal method is that when a new carrier frequency or RF level is entered the RF ALC system is enabled and a CW signal is generated. The generator then sets up the digitally derived control signal so that it is at the same level as the RF ALC control signal and the instrument disables the RF ALC and substitutes the digitally derived signal. The user of the signal generator will observe that when the level or frequency of the generator is changed a CW output burst (at the requested output level) is generated for up to 100 ms.

In some applications, such as live radar testing, the CW burst can cause problems. The alternative mode of operation is to enable a CW Burst Suppression facility. In this mode when pulse modulation is first enabled, a calibration of the digitally derived control signal is performed automatically which generates a tabulation of the RF level against the control signal level. During calibration the RF output is suppressed by the output attenuator. After calibration changes in level or frequency do not generate CW bursts. An RF level recalibration can be performed on demand. When the carrier frequency is changed by more than 15 MHz from the frequency at which the level was calibrated, or the new requested frequency results in a major change of characteristic (such as a VCO change), the RF level display is blanked and an UNCAL annunciator is displayed. Initiating an RF level calibration will restore the RF level display.

Selecting the pulse modulation mode

- (1) Press the [*RF Level Utility*] on the *Utilities Selection Menu 2*. The display will show the *RF Level Utility Menu* shown in Fig. 3-1-77.
- (2) Use the [*CW Burst Control*] key to disable the Burst Suppression mode for normal operation or enable it for Burst Suppression mode.
- (3) Selecting the [SIG GEN] key will return the display to the *Sig Gen* menu.

Selecting pulse modulation

From the *Sig Gen* menu press [*Pulse Mod*] to obtain the Pulse Mod display shown in Fig. 3-1-55.

Notes...

The [*RF Level Autocal*] key will only appear if the CW burst suppression mode has been enabled in which case a temporary calibration display will appear for approximately 1.5 s while calibration is undertaken.

Modulation can be enabled with FM but not with AM.

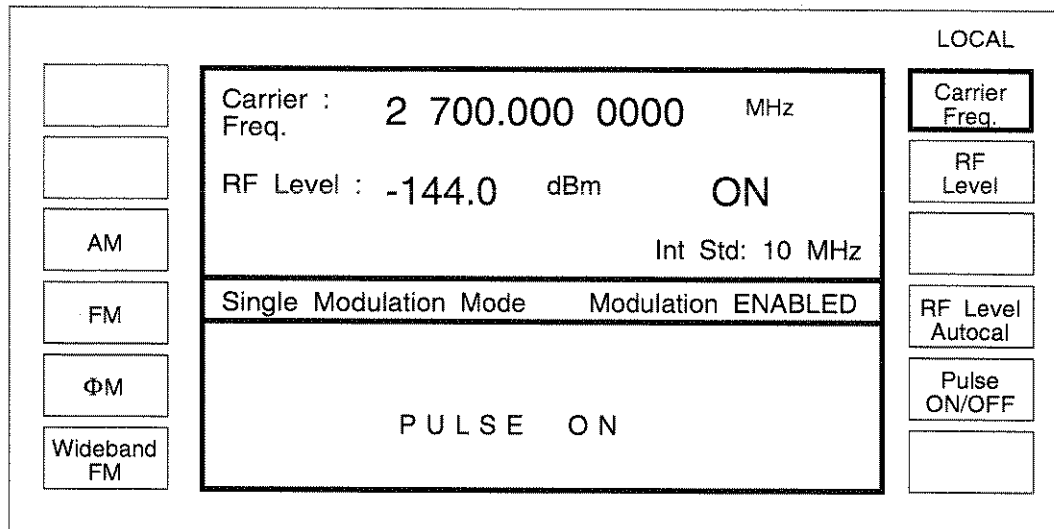

C1626

Fig. 3-1-55 Sig Gen menu with pulse modulation selected

The [*Pulse On/Off*] key can be used to disable or enable the pulse modulator without enabling the RF ALC system.

The [MOD ON-OFF] key will also disable or enable the modulator; the status being shown on the display.

With the modulation disabled using this key the RF ALC system is operating.

If the CW Burst Suppression mode has been enabled the [*RF Level Autocal*] key can be used to recalibrate the RF output level on demand.

Pulse modulation input level

Switch pulse mod on or off with the [*Pulse On/Off*] key. When 'On', the carrier is controlled by the logic level applied to the PULSE INPUT socket mounted on the front panel. A logical '1' (a voltage between 3.5 and 5 V) allows carrier output, a logical '0' (a voltage between 0 and 1.0 V) suppresses it. Turning pulse mod off effectively applies a logical '1' allowing carrier output. Note that the input impedance is 50 Ω .

Low intermodulation mode

When carrying out intermodulation tests the output signal from two signal generators is combined using a resistive or hybrid combiner. If the carrier frequencies are relatively close together each generator will receive an interfering signal from the other source. The RF ALC system will detect a beat frequency equal to the difference in carrier frequencies and attempt to apply AM in order to cancel the signal. In so doing the RF ALC system will generate AM sidebands which are indistinguishable from intermodulation products. By using the low intermodulation mode the RF ALC system can be disabled to prevent the injection of AM sidebands.

If pulse modulation is not fitted proceed as follows:

- (1) At the *Sig Gen* menu press [*Low Intermod*].
- (2) This causes either *Low Intermodulation Disabled* or *Low Intermodulation Enabled* to be displayed in the lower panel.
- (3) Press the [MOD ON-OFF] key to toggle between the enabled and disabled states.
- (4) If an attempt is made to [*Set Steps*] from the Δ menu, the message *Low Intermod: No Steps Allowed* will be displayed.

If pulse modulation (Option 002) is fitted proceed as follows:

- (1) Press the [*Pulse Mod*] key.
- (2) This causes the message *PULSE ON* to be displayed.
- (3) Press the [*Pulse ON/OFF*] key.
- (4) This causes *PULSE OFF* to be displayed together with *Low Intermodulation Disabled* or *Low Intermodulation Enabled* shown in the lower panel.
- (5) Press the [MOD ON-OFF] key to toggle between the enabled and disabled states.
- (6) If an attempt is made to [*Set Steps*] from the Δ menu, the message *PULSE : No Steps Allowed* will be displayed.

Note...

AM is not available in the Pulse Modulation or Low Intermodulation modes of operation.

SIGNALLING

CTCSS

A CTCSS tone is any one of 32 standard sub-audible tones ranging from 67 Hz to 250.3 Hz and would generally be used in conjunction with an audible modulation signal in a composite modulation mode. The procedure for initiating these tones is as follows:

Tone selection

- (1) At the *Sig.Gen* menu, press [*Select Source*].
- (2) At the *Internal Source Selection Menu*, press [CTCSS]. The *Continuous Tone Selection Menu* is now displayed, see Fig. 3-1-56.
- (3) Key in the required tone number (0 to 15) and press [enter].

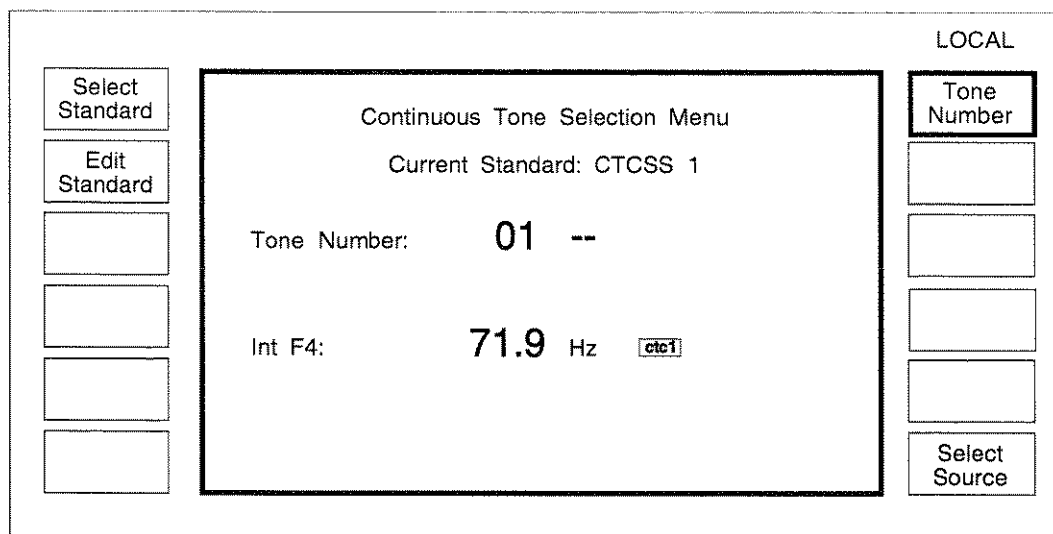

C1889

Fig. 3-1-56 Continuous tone selection menu

Selecting alternative tone standards

A list of the 16 tones of the current standard is available by pressing *[Select Standard]*. This action displays the *Tone Standard Selection Menu* with the current standard highlighted. To select from further lists of 16 tones, press *[CTCSS2]* or *[USER]*. The *Tone Standard Selection Menu* changes to show the new list.

Editing a tone standard

Pressing *[TEMP]* displays a further list of 16 tones set to the default value of 10 Hz. The standard can be edited by selecting *[Edit Standard]* from the menu in Fig. 3-1-56. This gives you the *Continuous Tone Edit Utility* menu.

CTCSS 1, CTCSS 2 or USER can be loaded to TEMP, which is a volatile store of 16 tones set at a default value of 10 Hz at switch on. Tones can then be changed by using *[Tone No]*, *[Tone Freq]*, *[Next Tone]* or *[Previous Tone]*. When the required changes have been made, the new standard can be saved by pressing *[Store to User]*. USER then becomes a user defined standard.

Note...

Selecting *[CTCSS1]*, *[CTCSS2]*, *[USER]* or *[TEMP]* from the *Tone Standard Selection Menu* causes the pictogram in the *Continuous Tone Selection Menu* and the *Internal Source Selection Menu* to change e.g. *ctc1*. The pictogram is repeated in the modulation section of the *Sig Gen* menu.

Sequential calling tones

There are eight sequential calling tone standards available, each having 16 set tones, see *Tone Standard Selection Menu*, Fig. 3-1-60. They are, CCIR, EURO, DZVEI, ZVEI1, ZVEI2, EEA, EIA and NATEL. There is also provision for the user to define sets of user tones in USER1 and USER2. DTMF signalling tones can also be generated if the second modulation oscillator (Option 001) is fitted.

Sequential calling tones are set up from a utility menu, Fig. 3-1-70, and are activated by pressing *[Send Tones]* which appears on the main menu after the tones have been set up. *[Send Tones]* also appears on the calling tones menu.

Tone selection

Pressing the [Calling Tones] soft key at *Utilities Selection Menu 1* calls up the *Sequential Calling Tones Utility* menu, see Fig. 3-1-57.

LOCAL

Sequential Calling Tones Utility
Current Standard: CCIR
Mode: NO MODULATION SELECTED

Tone Seq.: FFFFFFFFFFFFFFFFFF
Dur. Seq.: - - - - -

Frequency Offset : 0 %
Extended Duration: 500 ms
Repeat Tone : E -
Start Delay : 200 ms

Default Duration : 100 ms Gap : 6 ms

Mode Control
Select Standard
Edit Standard
Store Tones
Recall Tones

Tone Sequence
Duration Sequence
Freq. Offset
Extended Duration
Define Repeat
Start Delay

C0010

Fig. 3-1-57 Sequential calling tones utility menu

[Tone Sequence] Pressing this key causes hexadecimal data entry keys to appear at the left-hand side of the menu. To change the sequence, enter the tone numbers via the digits 0-9 on the numerical key pad and the soft keys [A] to [F] and press [enter].

[Duration Sequence] Pressing this key causes [Default Duration] and [Extended Duration] to appear at the left hand side of the menu. Press either key in turn to set the duration of tones in the sequence. A dash (-) indicates the default duration and E indicates an extended duration. These two keys disappear when [enter] is pressed.

[Define Repeat] allows a repeat tone to be defined, by using the [A] to [F] keys and the key pad and pressing enter. For example, if the repeat tone is defined as tone C, the sequence 11111 will be sent as 1C1C1 so that the receiver decoders will sense a change in frequency at the start of each digit sent.

[Freq. Offset] This facility alters the nominal tone frequency by a set percentage (up to $\pm 10\%$) for use in tolerance testing. To change the frequency offset value, select [Freq. Offset] and enter the new value on the key pad. Terminate with the [%] key.

[Store Tones] Up to 20 sequence set-ups can be stored. Use the key pad to enter the store location number and press [enter].

[Recall Tones] To recall a tone sequence, use the key pad to select the required store location and press [enter].

[Start Delay] The delay before the tone sequence starts and the gap between sequences can be adjusted by pressing this soft key, entering the required delay time on the key pad and pressing [ms].

[Mode Control] Pressing this enables the user to assign the calling tones to a selected type of modulation, see Fig. 3-1-59. Modulation, on the selected channel, is turned off when the tones are triggered and restored after the tones have been sent. Modulation on other channels is not affected by the calling tones and this allows sequential signalling tones to be combined with

sub-audible tones. *[NO mod]* This option effectively inhibits sequential tones. The tone sequence can be sent between 1 and 9 times, set by *[No. of Repeats]*, every time the *[Send Tones]* key is pressed. Setting the number of repeats to 10 allows the tones to be sent continually under control of the *[Send Tones]/[Stop Tones]* key at the main menu.

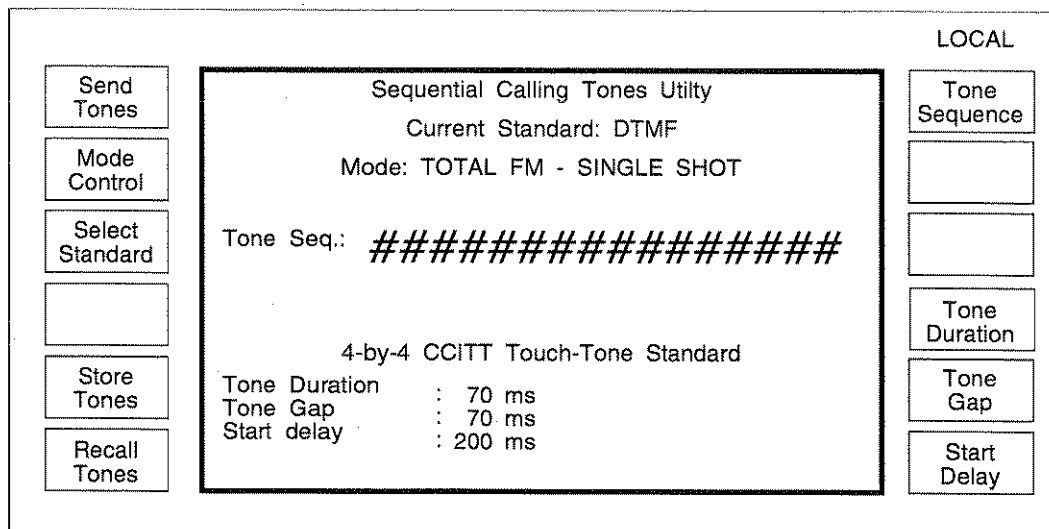

C1890

Fig. 3-1-58 Sequential calling tones utility menu (DTMF mode)

On 2050 series fitted with the second modulation oscillator (Option 001) the DTMF signalling capability is also provided. If this standard is selected then the main menu accessed after pressing the *[Calling Tones]* soft key at *Utilities Selection Menu 1* will be as shown in Fig. 3-1-58. The functions of the soft keys are as follows:

[Tone Sequence] Pressing this key allows a tone sequence to be set up using the digits 0-9 on the numerical key pad and the soft keys *[A]*, *[B]*, *[C]*, *[D]*, *[*]* and *[#]*. The sequence entry is terminated by pressing *[enter]*.

[Tone Duration] The default duration of 70 ms for each tone in the sequence can be changed by pressing this key, entering the required duration value and pressing *[ms]*.

[Tone Gap] The default gap duration of 70 ms between each tone in the sequence can be changed by pressing this key, entering the required gap length and pressing *[ms]*.

[Start Delay] The delay before the tone sequence starts and the gap between sequences can be adjusted by pressing this soft key, entering the required delay time on the key pad and pressing *[ms]*.

[Mode Control] Pressing this enables the user to assign the calling tones to a selected type of modulation, see Fig. 3-1-59. Modulation, on the selected channel, is turned off when the tones are triggered and restored after the tones have been sent. Modulation on other channels is not affected by the calling tones and this allows sequential signalling tones to be combined with sub-audible tones. *[NO Mod.]* This option effectively inhibits sequential tones. The tone sequence can be sent between 1 and 9 times, set by *[No. of Repeats]*, every time the *[Send Tones]* key is pressed. Setting the number of repeats to 10 allows the tones to be sent continually under control of the *[Send Tones]/[Stop Tones]* key at the main menu.

[Select Standard] Selection of alternative signalling standards is achieved by pressing this key to access the *Select Standard Menu*.

[Store Tones] Up to 20 sequence set-ups can be stored. Use the key pad to enter the store location number and press [enter].

[Recall Tones] To recall a tone sequence, use the key pad to select the required store location and press [enter].

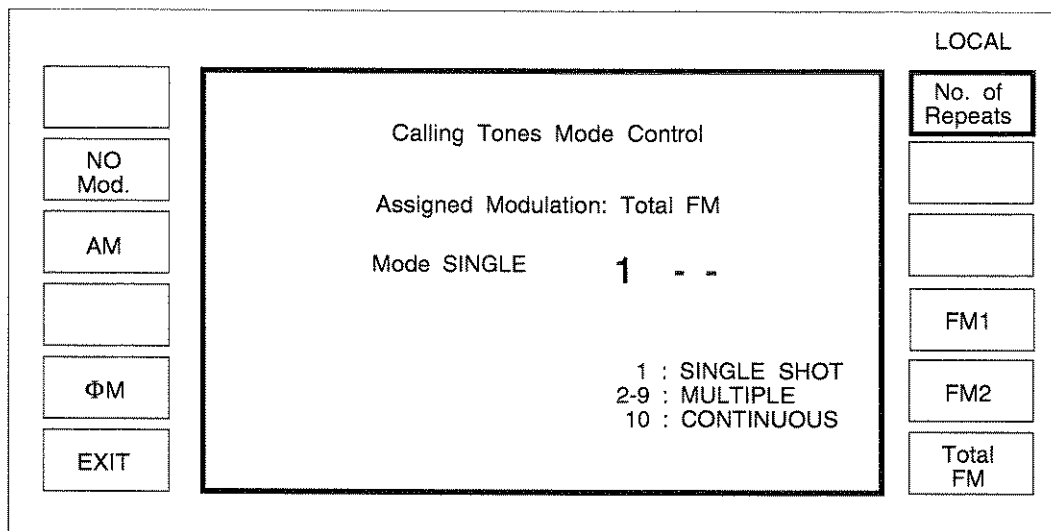

C0011

Fig. 3-1-59 Calling tones mode control menu (with [FM] selected)

Selecting alternative tone standards

The *[Select Standard]* key causes the *Tone Standard Selection Menu* to be displayed, see Fig. 3-1-60.

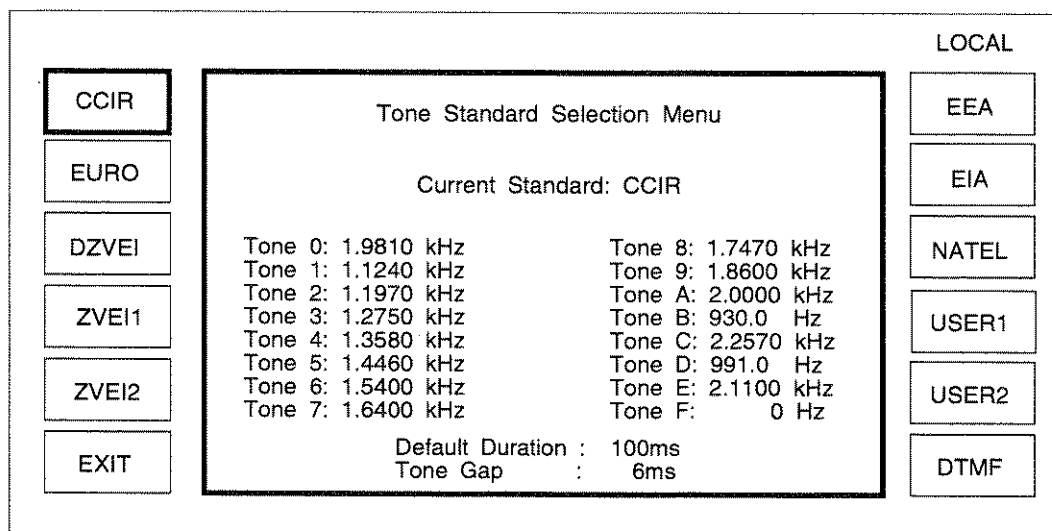

C0012

Fig. 3-1-60 Tone standard selection menu

The tone sequential standard to be used is selected by pressing the appropriate soft key. This menu also shows the frequency and timing characteristics for each tone in the standard. User 1 and User 2 are user defined tone standards stored in non-volatile memory. The *[DTMF]* soft key only appears on the display if the instrument is fitted with a second modulation oscillator (Option 001 fitted). If only a single oscillator is fitted the *[DTMF]* key is left blank

Editing a tone standard

Pressing the *[Edit Standard]* key when in the *Sequential Calling Tones Utility* menu (Fig. 3-1-57) will produce the *Edit Sequential Tones Utility*, see Fig. 3-1-61, which allows a user defined tone system to be set up.

All editing is carried out in a tone standard called TEMP which is not stored beyond switch off. To ensure that the alterations are available for future use the newly defined tone standard must be saved to non-volatile storage in either USER1 or USER2.

The editing facility allows the user to define the frequency of each of the 16 tones in the system and to set the default duration of each tone in the sequence and the gap between tones (if any). All other settings are handled in the normal *Sequential Tones Utility* menu.

The currently selected tone standard may be copied into the TEMP working space using the top left soft key (shown *[CCIR to TEMP]* in Fig. 3-1-61) and often this is a convenient way to start, particularly when the user defined system is similar to one of the standard systems.

To edit the system in TEMP use *[Tone Number]* to select the number of the tone to be edited (0 to 15) and after pressing *[Tone Freq.]* enter the new frequency to be assigned to this tone number. Select other tones in the system by means to the *[Tone Number]* key or use the *[Next Tone]* and *[Previous Tone]* keys to step through the list. Enter the frequencies of the tones and then use *[Default Duration]* and *[Tone Gap]* to set the times in milliseconds for the default duration of each tone and the gap between each tone.

Finally store the user defined tone system parameters in USER1 or USER2 by pressing *[Store to USER1]* or *[Store to USER2]*.

Note that when using the DTMF tone signalling capability no editing facility is provided. Changes to the default settings are made directly on the *Calling Tones Utility Menu*.

		LOCAL
CCIR to TEMP	Edit Sequential Tones Standard	Tone Number
	Tone Number: 0 - -	Tone Freq.
Store to USER1	Tone Frequency : 10.0 Hz	Default Duration
Store to USER2	Default Duration : 100 ms	Tone Gap
	Tone Gap : 0 ms	Next Tone
EXIT		Previous Tone

C3319

Fig. 3-1-61 Edit sequential tones standard menu

INCREMENTING (using Δ)

Displaying shifts

Press the [Δ] hard key. The total shift menu is displayed as shown in Fig. 3-1-62. This menu displays the difference between the current value and the keyed-in value. Parameters can be incremented or decremented by using the [\uparrow] or [\downarrow] key or the control knob, see 'Using the control knob' on Page 3-1-12. To cancel any changes made by the rotary control or the [\uparrow]/[\downarrow] keys, press [Return Value]. This will restore the setting of the selected parameter to the keyed-in value, i.e. the indicated shift will return to zero. Pressing [Transfer Value] transfers the current value to the Sig Gen menu as the keyed-in value.

Transfer Value	Carrier + Freq.	0	Hz	LOCAL	Carrier Shift
Return Value	RF Level +	0.0	dB	ON	RF Shift
AM				Int Std: 10 MHz	FM Shift
	Single Modulation Mode			Modulation ENABLED	Int F4 Shift
Φ M	FM+	0	Hz	ON	FM ON/OFF
Set Steps	Int F4+	0	Hz		

C00014

Fig. 3-1-62 Total shift menu

Setting increment values

- (1) From the total shift menu select [Set Steps]. The screen shows the currently set step sizes.
- (2) Select [Carrier Step], enter the value on the key pad and press a terminator key. The step value will appear on the screen.
- (3) Return to the Sig Gen menu by pressing [SIG GEN].
- (4) Using the [\uparrow]/[\downarrow] keys respectively will now increment or decrement the carrier frequency by the set value.
- (5) [RF Level Step], [AM Step] and [Source Step] values can be entered in the same way.

Note...

Wideband FM and Pulse modulation parameters cannot be incremented in this manner.

SWEEP

The sweep capability allows the comprehensive testing of systems, as measurements at single points will not necessarily give an overall indication of the performance. The sweep function is specified by the following parameters:

- Start value
- Stop value
- Number of steps
- Time per step

Up to five individually adjustable markers may be set. Each marker can be turned on and off separately. Sweep functions available are:

- Carrier frequency with or without modulation
- RF level
- Internal modulation rate
- LF frequency (if in LF generator mode)
- LF level (if in LF generator mode).

The sweep can be operated in single shot or continuous modes with the start command triggered by a key press, an external pulse or GPIB control. Once started, the sweep can be stopped at any time when the display will indicate the current parameter value. The sweep can be used with oscilloscopes, X-Y display units and X-Y plotters by connecting the display unit X input to the SWEEP RAMP output on the rear panel.

A sweep routine is set up as described in the following paragraphs:

Sweep type

- (1) Press the [SWEEP] hard key. The sweep parameters display, with soft key options, appears on the screen, see Fig. 3-1-63.

		LOCAL
Start Sweep	Level Start: -144.0 dBm	Start RF Level
	Level Stop: +13.0 dBm	Stop RF Level
	Number of: 1000 -----	Number of Steps
Markers	Step Time: 50 ms	Step Time
Sweep Mode	Sweep Status: WAITING FOR TRIGGER	
Sweep Type	Sweep Mode: INTERNAL SINGLE	
	Sweep Type: RF LEVEL	

C1899

Fig. 3-1-63 Sweep parameters display

- (2) Press [Sweep Type]. The *Sweep Type Menu* is displayed, see Fig. 3-1-64.

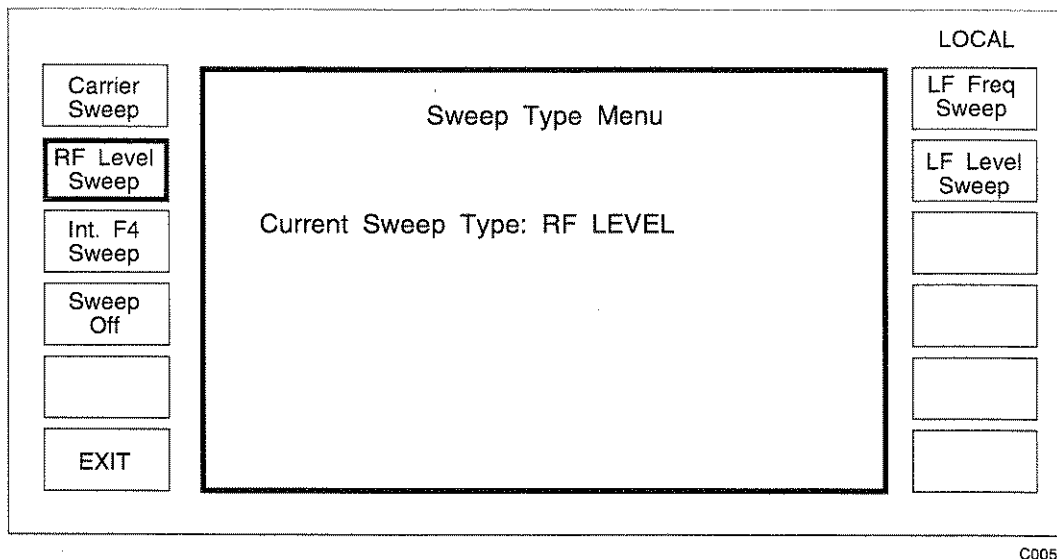

Fig. 3-1-64 Sweep type menu

The instrument must be in the LF generator mode before an LF frequency sweep and LF level sweep can be initiated.

Modulation required during sweep should be entered before putting the instrument in the sweep mode.

- (3) Select the required sweep type by pressing the appropriate soft key, e.g. [Carrier Sweep]. The Sweep Type screen changes to confirm the selection.
- (4) Press [EXIT] or [SWEEP] to return to the sweep parameters display.

Sweep mode

- (1) At the sweep parameters menu, press [Sweep Mode]. The *Sweep Trigger Mode Menu* is displayed, see Fig. 3-1-65.

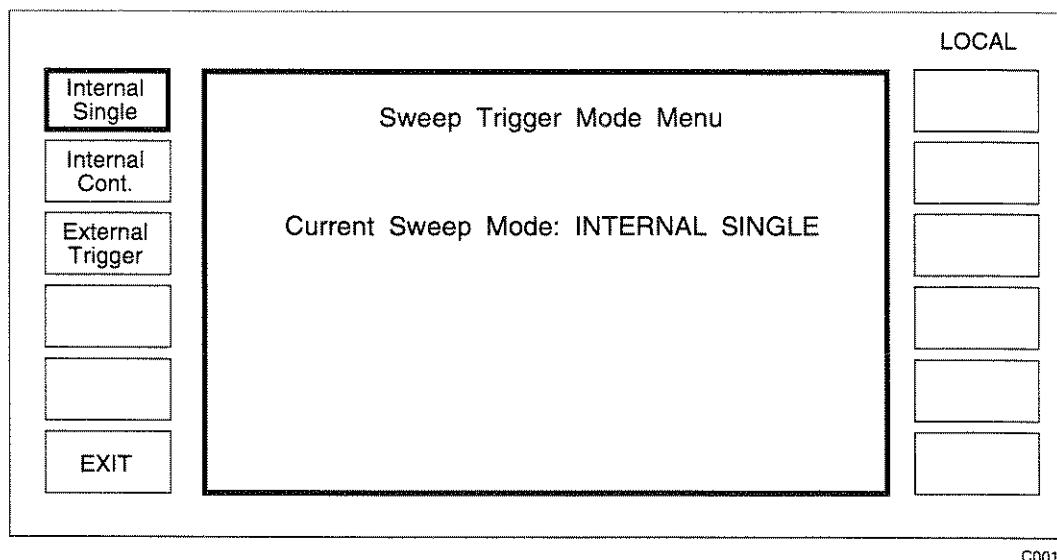

Fig. 3-1-65 Sweep trigger mode menu

- (2) Select the sweep mode, [*Internal Single*], [*Internal Cont.*], or [*External Trigger*].
- (3) Press [*EXIT*] to return to the sweep parameters display menu.
- (4) If [*External trigger*] is selected, press [UTIL], select [*Utils. Menu 1*] and from this menu press [*External Trigger*]. The *External Trigger Selection Menu* will be displayed. Then press [SWEEP] to return to the Sweep Parameters display.

Sweep parameter entry

Start value

- (1) Select the appropriate soft key to enter the start value, e.g. [*Start Freq*].
- (2) Enter the required start value via the numerical key pad and the appropriate terminator key.

Stop value

- (1) Select the appropriate soft key to enter the stop value, e.g. [*Stop Freq*].
- (2) Enter the required stop value via the numerical key pad and the appropriate terminator key.

When carrier frequency parameters are entered, the instrument calculates all the individual step values together with any level and modulation correction factors. While this process is taking place, the sweep status line changes to indicate 'CALCULATING SWEEP'.

Number of steps

- (1) Select [*Number of Steps*].
- (2) Enter the number of steps via the numerical key pad and the [GHz/V/enter] terminator key.

Note...

If an inappropriate number of steps is selected, the instrument will automatically choose a more reasonable value. The number of steps available depends on the operating mode and the maximum values are:

- 250 for carrier frequency with FM, Φ M or Wideband FM enabled
- 1,000 for carrier frequency without FM, Φ M or Wideband FM enabled.
- 10,000 for RF level, RF modulation frequency, LF frequency and LF level.

Step time

- (1) Select [*Step Time*].
- (2) Enter the step time via the numerical key pad and the [MHz/mV/ms] terminator key.

Markers

A facility exists for producing markers, controlled by the *Sweep Markers Menu*, see Fig. 3-1-66.

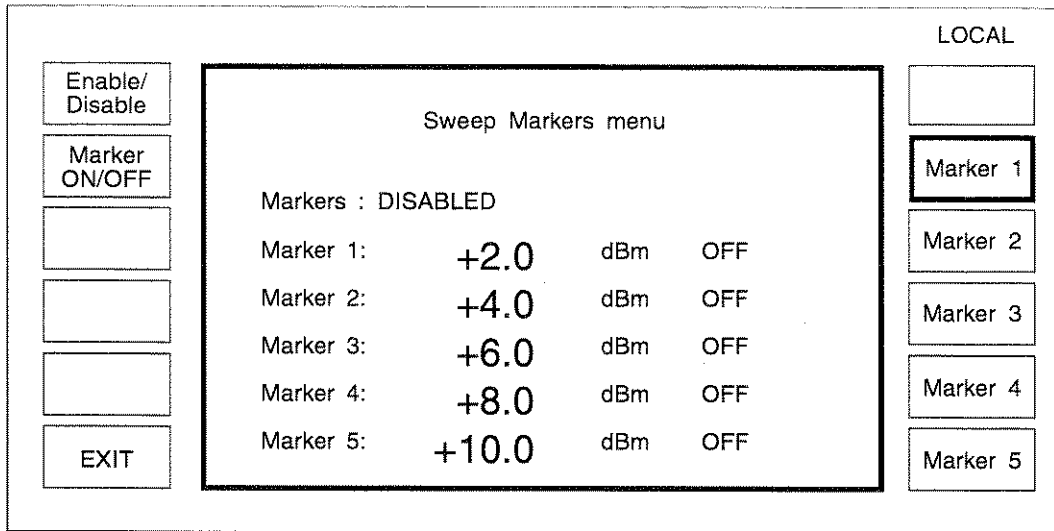

C1891

Fig. 3-1-66 Sweep markers menu

To set a marker, press one of the marker soft keys e.g. [Marker 3], enter the required value on the key pad and terminate with the appropriate units hard key. Turn the marker ON using the [Marker ON/OFF] key. When all markers have been entered use the [Enable/Disable] key to activate the marker output on the rear panel. The marker output produces a positive going pulse with a duration of one sweep step when the sweep passes a marker value.

Sweep control

Starting the sweep

From the sweep parameters menu, press [Start Sweep]. The single sweep status line display changes from *WAITING FOR TRIGGER* to *SWEEPING* and a solid bar increments to show the sweep progression, see Fig. 3-1-67.

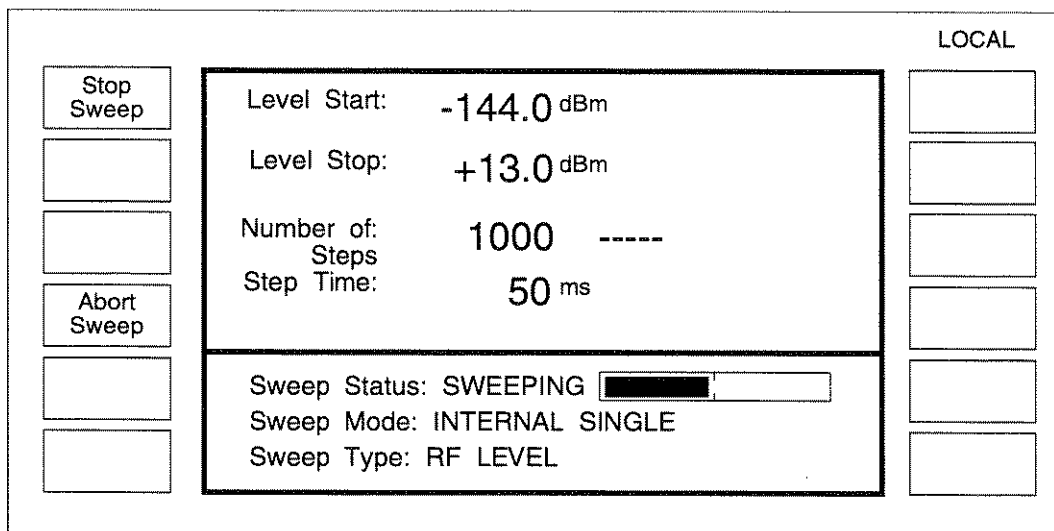

C1900

Fig. 3-1-67 Sweep in progress

Note ...

When the sweep is in progress, all the hard keys are disabled and only the [Stop Sweep] and [Abort Sweep] soft keys are active .

Stopping the sweep

Press [Stop Sweep]. The sweep stops and the menu presents the opportunity to press:- [Reset Sweep] to change the sweep parameters, or [Continue Sweep] to continue the sweep, or [Transfer] to transfer the current value of the swept parameter as the last keyed in value in the [SIG GEN] or [LF]([LF Gen]) mode, see Figs. 3-1-68 and 3-1-69. When the sweep is in the paused state, the [↑] and [↓] keys can be used to step the parameter up or down. The sweep can then be continued by pressing [Continue Sweep].

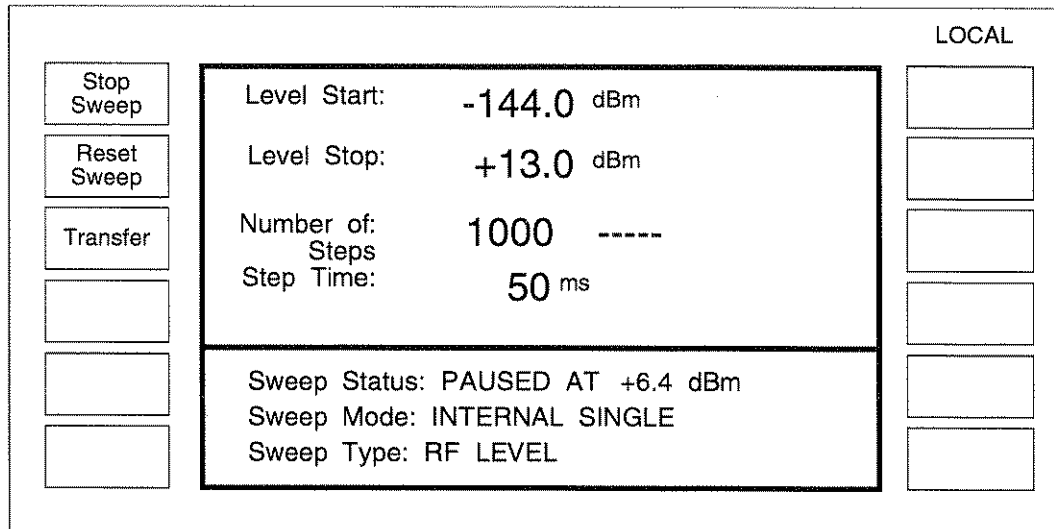

C1901

Fig. 3-1-68 Sweep stopped

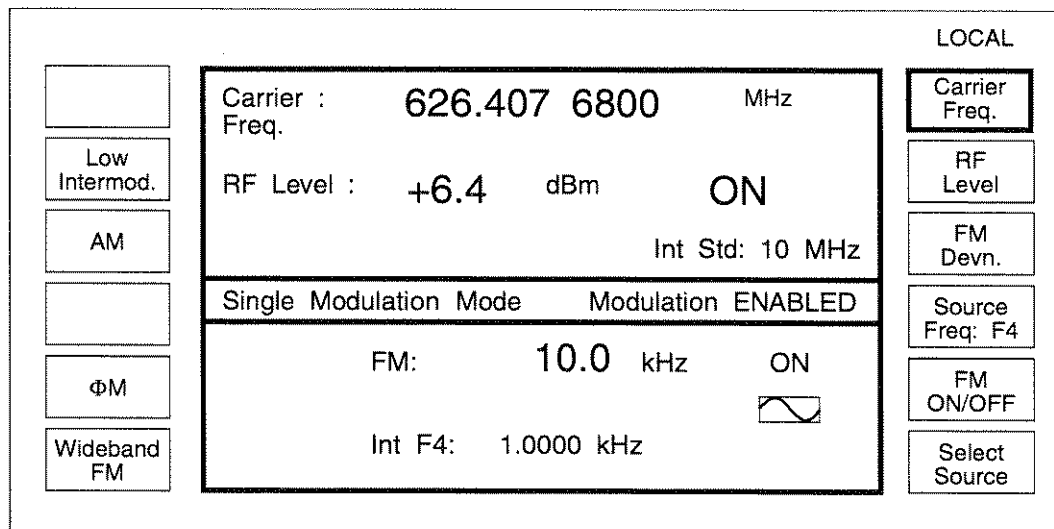

C1902

Fig. 3-1-69 RF level transferred

Aborting the sweep

Press *[Abort Sweep]*. The sweep is reset and the RF (or LF) signal is removed from the appropriate output socket. The *Sweep Parameters Menu* as shown in Fig. 3-1-63 is displayed. If the sweep is restarted with the signal disabled, the *[Abort Sweep]* key is not displayed thus giving the user an indirect indication that no signal is being output from the instrument.

UTILITIES

The utilities options are accessible from two primary menus, *Utilities Selection Menu 1* and *Utilities Selection Menu 2*. When a selection is made from either of these menus and [UTIL] is subsequently pressed, the primary menu is re-displayed. However, if instead a selection is made and then one of the other hard keys e.g. [SWEEP] is pressed, pressing [UTIL] subsequently once returns to the sub-menu, pressing it again returns to the primary menu. This provides an operating short-cut in that it allows a sub-menu to be re-accessed without first having to go again through the primary menu. This scheme does not apply to the [Time & Date] or to the [Set Time & Date] soft keys. The display for *Utilities Selection Menu 1* is shown in Fig. 3-1-70. To obtain *Utilities Selection Menu 2* from the menu, press [Utils. Menu 2].

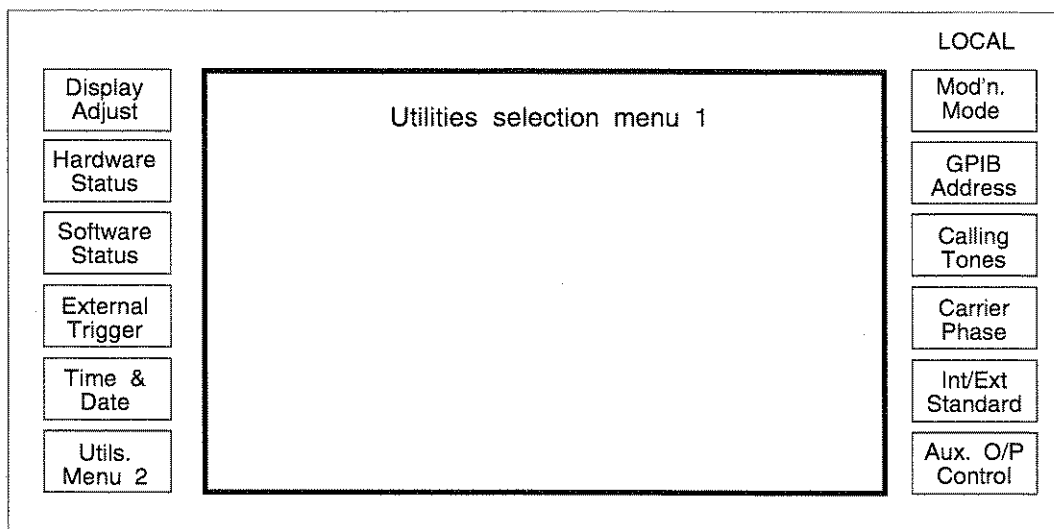

C1655

Fig. 3-1-70 Utilities selection menu 1

Adjusting the display

To adjust the display, press [Display Adjust]. The *Display Adjust* menu is displayed on the screen, see Fig. 3-1-71. The backlight, which is on when the instrument is switched ON, can be toggled ON or OFF using the [Display ON/OFF] key, and when ON can be varied in brightness by [Dim], [Medium 1], [Medium 2] and [Bright]. Contrast is adjusted with the control knob. Once adjusted, the LCD setting can be stored in the non-volatile memory by pressing [Save LCD Setting]. The instrument always activates the backlighting whenever it is switched on.

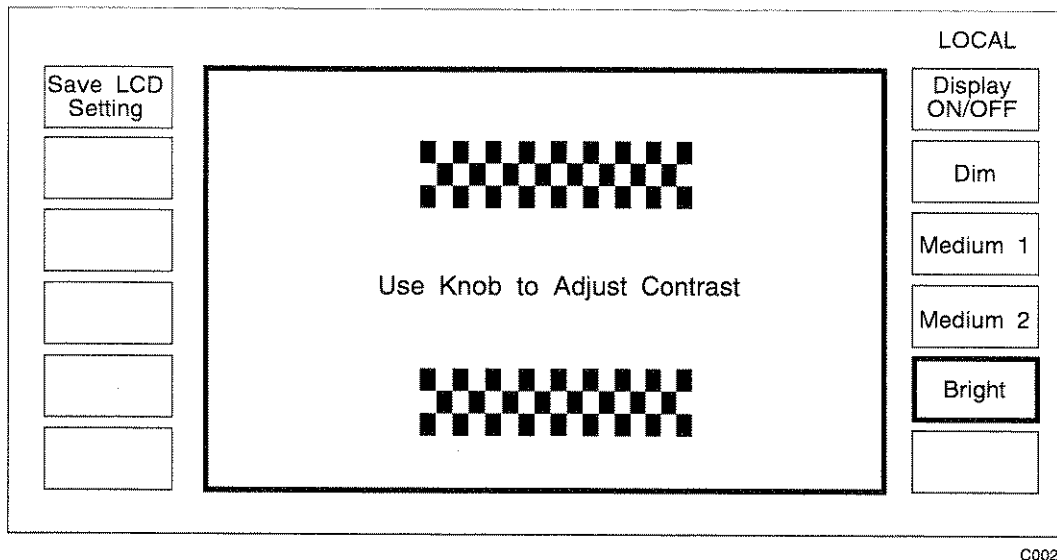

Fig. 3-1-71 Display adjust menu

Hardware information

To obtain a description of the instrument hardware, press [*Hardware Status*] and the following information is displayed:

Instrument type (e.g. 2051)
 Serial no. (e.g. 1543256/045)
 Options fitted (e.g. *SECOND LF OSC.*)
 Attenuator type and serial number.

For attenuator calibration information, refer to the Service Manual.

Software information

To obtain a description of the instrument software, press [*Software Status*] and the following information is displayed:

Software Version Number e.g. 7.001
 Part number e.g. 44533-1-419
 GPIB address e.g. 01

External trigger

The external trigger facility allows the rear panel TRIGGER input to be set up so as to initiate a defined change in the generator setting. To define the function press [*External Trigger*]. The display changes to show the *External Trigger Selection Menu* which has the following options:

[<i>Sweep Start</i>]	Starts the external sweep.
[<i>Sweep Step</i>]	Goes to next step of external sweep.
[<i>Send Seq Tones</i>]	Equivalent to [<i>Send Tones</i>] on main menu.
[<i>Recall Up</i>]	Recall next store.
[<i>Recall Down</i>]	Recall previous store.
[<i>No Ext. Trigger</i>]	Trigger ignored (default)

The external TRIGGER input requires a TTL type input and includes an internal pull-up resistor to +5 V. A switch closure to ground or an applied voltage transition from +5 V to 0 V on the rear panel socket initiates the defined trigger action.

Setting the modulation mode

Modulation mode selection allows the generator to be configured to provide carriers modulated by one, two or four (2 internal and 2 external) modulation sources.

Press [*Mod'n Mode*] to display the *Modulation Mode Selection Menu*, choose the type of modulation required by pressing [*Single*], [*Dual*], [*Comp*] or [*Dual Comp*], see 'Modulation mode selection' above.

Setting the GPIB address

Press [*GPIB Address*] to display the *GPIB Address Change Menu*. To change the address, enter the address, in the range 0-30, via the numerical key pad and press [enter]. The data is then saved automatically in the non-volatile memory. For information on operating the instrument via the GPIB, refer to Chapter 3-1-2.

Sequential calling tones

Sequential calling tones are set up from a utility menu, Fig. 3-1-70, and are activated by pressing [*Send Tones*] which appears on the main menu after the tones have been set up. [*Send Tones*] also appears on the calling tones menu. Pressing the [*Calling Tones*] soft key at *Utilities Selection Menu 1* calls up the *Sequential Calling Tones Utility* menu, see 'SIGNALLING'.

Carrier phase adjustment

Pressing [*Carrier Phase*] displays the *Carrier Phase Control Menu*. To advance or retard the carrier phase (with respect to its current phase) in steps of $\pi/128$ radians, approximately 1.4° , rotate the control knob clockwise to advance the phase and counter-clockwise to retard the phase.

Selection of frequency standard

Pressing [*Int/Ext Standard*] changes the menu to display the *Frequency Standard Selection Menu* which controls the internal/external frequency standard facilities. The signal generator can be set to operate from an external standard or from the internal standard with or without the standard being provided on the rear panel *FREQ STD IN/OUT* connector.

The menu has the following options:

Output DISABLED

- 1 MHz Int. Std.*
- 5 MHz Int. Std.*
- 10 MHz Int. Std.*

- 1 MHz Ext. Std.*
- 5 MHz Ext. Std.*
- 10 MHz Ext. Std.*

Internal standard disabled at the *FREQ STD IN/OUT* connector.

Internal standard with an output at the selected frequency on the *FREQ STD IN/OUT* connector.

Accepts an external frequency standard at the selected frequency on the *FREQ STD IN/OUT* connector.

These settings are saved in non-volatile memory to ensure that the settings are recalled when power to the instrument is restored.

Latch data utility

The [Aux. O/P Control] key on the *Utilities Selection Menu 1* is used as a convenient means to change the data in the internal hardware latches as well as to control an external device connected to the AUXILIARY IN/OUT connector. Pressing the [Aux. O/P Control] key causes the latch data utility shown in Fig. 3-1-72 to be displayed.

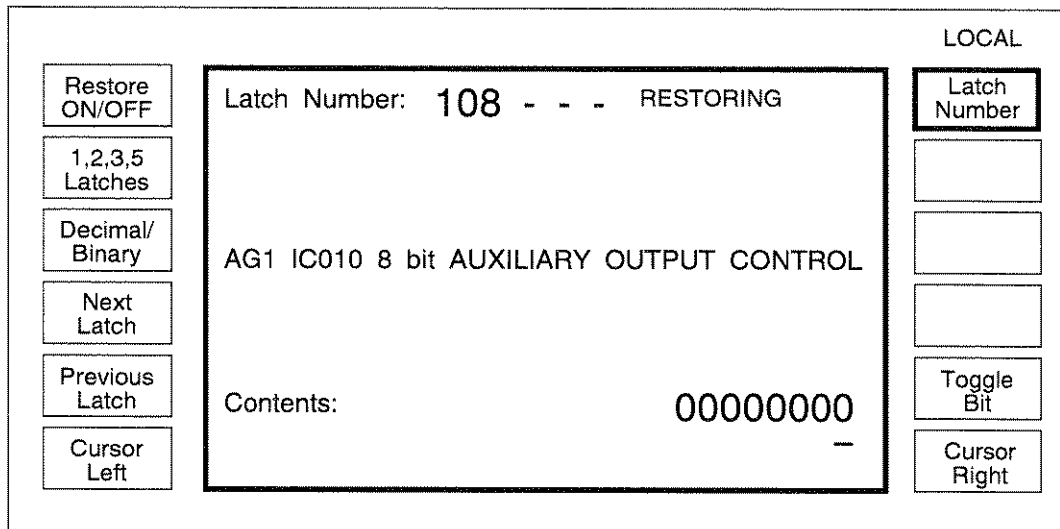

C0854

Fig. 3-1-72 Latch data utility with single latch selected in binary mode

Pressing the [Restore ON/OFF] soft key on the utility toggles between Restoring and Non-Restoring mode.

In Restoring mode latches whose values have been changed by the user are restored to their previous value when ANY latch is updated outside the utility (i.e. by changing any parameter). This allows the user to select for example the *Sig Gen* menu to inspect the settings and return to the Latch Data Utility without restoring, but ensures that the instrument will operate in the correct manner after using this utility.

In Non-Restoring mode the modified latch will not be restored until that particular latch requires updating because of a changed parameter. The user should be aware that changing a parameter may affect latches associated with other functions, in particular changing the carrier frequency is likely to update latches associated with modulation and RF level as well as the ones associated with frequency.

[*Latch Number*] is a function to specify the index number of the latch to be inspected or set. Press numeric keys and terminate with [enter]. Information about the selected latch is displayed on the screen, this includes the board designation, the IC designation and a brief description of the function of the latch e.g. Latch 0 - AA1 IC402 12 bit FM CH1 DAC (low byte). Latch numbers are indicated in a box adjacent to the appropriate IC on the circuit diagrams.

Selecting latch 108 enables 8 output lines to be configured to the rear panel AUXILIARY IN/OUT connector. These may be used to drive external switches, filters etc.

[*1,2,3,5 Latches*] allows groups of consecutive latches to be treated as a single number. The 2 latches setting is useful for the various 12-bit DACs, the 3 latches setting for the 24-bit numbers used for the modulation oscillators and the 5 latches setting for the 40-bit numbers used in the fractional-N controller. Each press of this key advances the selection in the sequence 1-2-3-5-1... Information about the selected number of latches (starting at the chosen Latch Number) is displayed.

[*Decimal/Binary*] selects whether latch data is displayed or entered in decimal or binary format. Binary is only available when the number of latches selected is 1 or 2.

In Decimal Mode:-

[*Latch Data*] is a function key that allows decimal data to be written to the selected latch or latches. When this key is highlighted the user may enter a number in the ranges 0 to 255, 0 to 65535, 0 to 16777215 or 0 to 1099511627775 (for 1, 2, 3 or 5 latches) terminated with [enter], at which time the data is written to the latch.

In Binary Mode:-

[*Cursor Left*], [*Cursor Right*] moves the cursor (underscore) left or right along the 8 or 16 displayed bits.

[*Toggle Bit*] changes the state of the bit at the cursor from 1 to 0, or 0 to 1, the new 8- or 16-bit value is written to the latch/latches immediately.

[*Next Latch*], [*Previous Latch*] increments/decrements the Latch Number by 1, 2, 3 or 5 (as selected by [*1,2,3,5 Latches*]).

A list of hardware latches is given in the Maintenance Manual.

Notes...

Certain latches are read-only, this is usually obvious from the latch description. If this is the case entered data has no effect and the old value is redisplayed.

Changes to the GPIB write latches (112 to 119) can only be restored by switching the instrument off and on again, so should be used with caution.

The Nibble Bus Protocol Latch (111) is always restored.

Menu exit

Press [SIG GEN] to return to the *Sig Gen* menu where further selections may be made.

Selection menu 2

Press [*Utils. Menu 2*] from *Utilities Selection Menu 1*. The display now changes to show *Utilities Selection Menu 2*, see Fig. 3-1-73. This menu allows access to the protected data. Utilities on this menu have either 1st or 2nd level protection.

If the instrument is locked, the appropriate level must be unlocked otherwise the utility will only be usable in a read only mode. To change parameters, the function must be unlocked. The procedure is:

[UTIL] ⇒ [*Utils. Menu 2*] ⇒ [*Lock & Unlock*] ⇒ *Function Unlocking Utility* menu ⇒ [*Unlock Level 1*] or, for servicing, [*Unlock Level 2*].

The correct password must be entered. Many of these activities are intended for use in servicing and are described in the Service Manual.

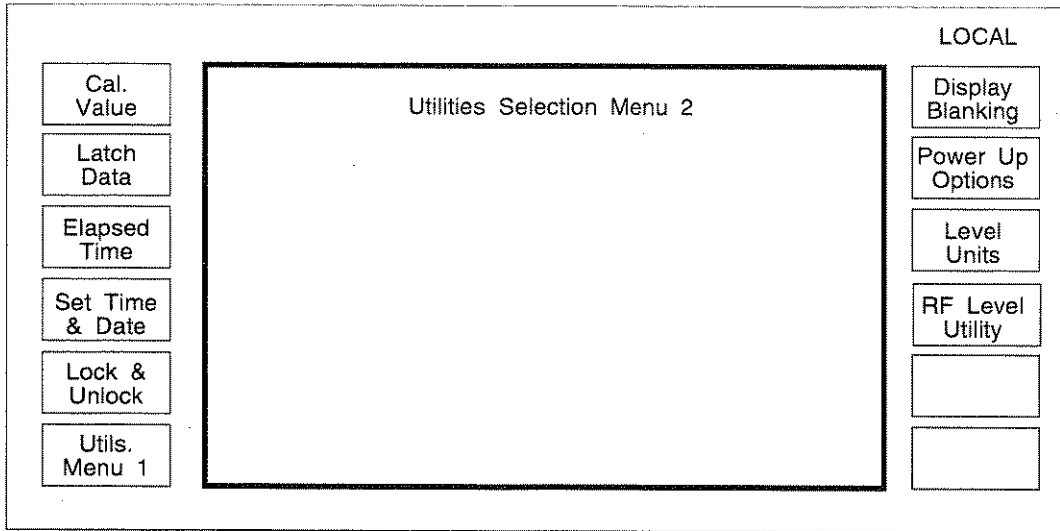

C0939

Fig. 3-1-73 Utilities selection menu 2

Calibration

Pressing [Cal. Value] brings the *Calibration Utilities Menu* to the display, see Fig. 3-1-74. This menu shows when the last complete check was made and when the next calibration check is due. It also shows the date on which the individual items were adjusted. It is possible to inspect the calibration value of these items but calibration cannot be carried out unless the protection facility is unlocked at Level 2. Full details regarding calibration can be found in the Service Manual.

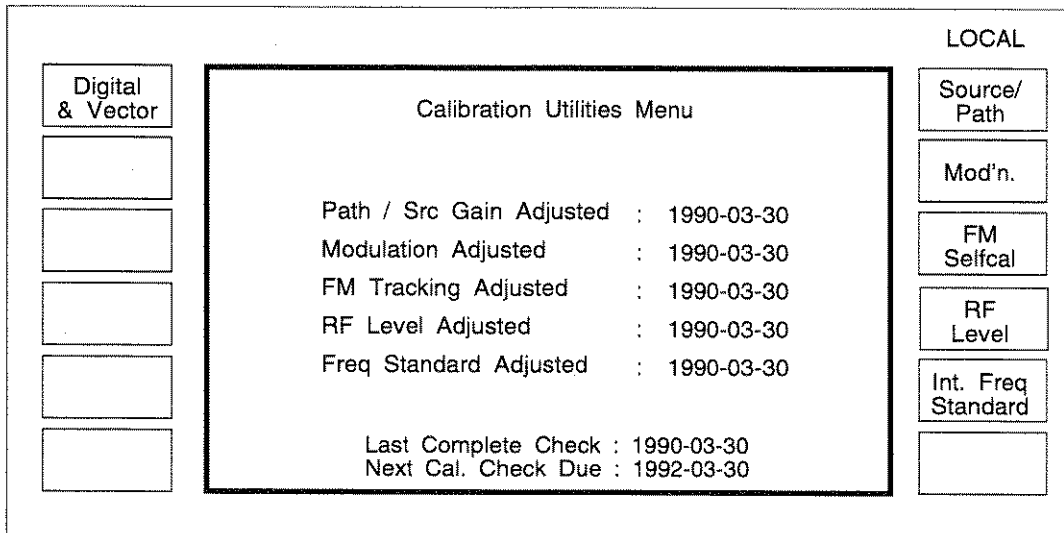

C1656

Fig. 3-1-74 Calibration utilities menu

Latch data

The latch data menu is intended for use as a diagnostic aid by allowing data to be sent to latches within the instrument. For further information consult the Service Manual.

Elapsed time

The elapsed time facility displays the number of operating hours since the function was last reset. Pressing [*Elapsed Time*] displays the number of operating hours and the date on which the function was last set to zero. This facility can be used to assess the instrument's operational reliability and utilisation.

Locking and unlocking

Press [*Lock & Unlock*]. When Level 1 and Level 2 are both locked, the menu displays three soft keys:

Unlock Level 1
Unlock Level 2
Serial No. Set

Press [*Unlock Level 1*] and the message *Enter 4 Digit Password:* will appear on the display. Level 1 is unlocked by entering the 4 digits on the key pad and pressing [enter]. The menu will change and two soft keys, [*Lock level 1*] and [*Lock Keyboard*], will appear on the left-hand side. The default password is 1234. If this password is not recognised by the instrument, the password has been changed by your calibration/repair department personnel who should be consulted for further information. [*Unlock Level 2*] is only used during servicing. Refer to the Service Manual for details.

Setting time and date

Unlock to Level 1 (see 'Selection menu 2' and 'Locking and unlocking' above). Set the time and date by pressing [*Set Time & Date*] at *Utilities Selection Menu 2*. The screen shows the current time, date and day of the week. The time shown does not change during display. The clock is powered by a rear panel battery, see Chap. 2, 'BATTERY REPLACEMENT'.

[*Set Time*] Press this key to set the time. Using the key pad enter the hour and minutes (24 hour clock). Separate the hour and minutes fields by a hyphen, e.g. 21-30. Terminate the entry by [enter] which starts the clock.

[*Set Date*] Press this key to set the date (in ISO format). Using the key pad enter the year, month and day. Separate the year, month and day fields by a hyphen e.g. 1994-04-23. Terminate the entry by [enter]. The day of the week is automatically determined when the date is set.

Keyboard locking

Unlock to Level 1, see 'Selection menu 2' and 'Locking and unlocking' above. Keyboard operation is disabled by pressing [*Lock Keyboard*]. The instrument automatically returns to the main menu which indicates the locked status by displaying a key-shaped icon in the top left-hand corner of the display. The keyboard can be re-enabled by entering the 4 digit password for Level 1 using the key pad and pressing [enter]. The keyboard status is saved in the non-volatile memory.

Display blanking

To prevent sensitive data from being displayed, the 2050 Series Signal Generators include a display blanking facility. This allows various parts of the display to be replaced by a series of dashes so that values entered by the user or recalled from the memory will not be visible. The instrument must be unlocked to Level 2 to enable or disable this facility. Consult the Service Manual for further information.

Power up options

Unlock to Level 1, see 'Selection Menu 2' and 'Locking and Unlocking' above. Two options are available by pressing [Power Up Options] at Utilities Selection Menu 2. These options are [Factory] and [Memory]. When [Factory] is pressed, the factory set power up state is recalled. Pressing [Memory] causes [Memory Number] to appear at the right-hand side of the menu. To change the power up state of the instrument to a particular setting, enter the memory number of the full store on the key pad and press [enter].

RF level units

RF output level units can be altered using the [Level Units] key. The level units may be entered as an EMF or PD, and the logarithmic units can be referred to volts (dBV), millivolts (dBmV), microvolts (dB μ V) or to 1 milliwatt into 50 Ω (dBm). Select the units by pressing [Level Units] which displays the RF Level Units Selection Menu shown in Fig. 3-1-75.

To change the default RF level units shown at switch on, first unlock the instrument to Level 1. This causes an additional soft key to be displayed in the top left box (see Fig. 3-1-75). Select the required RF level units and press the additional [Save RF Units] key to save these as the default units.

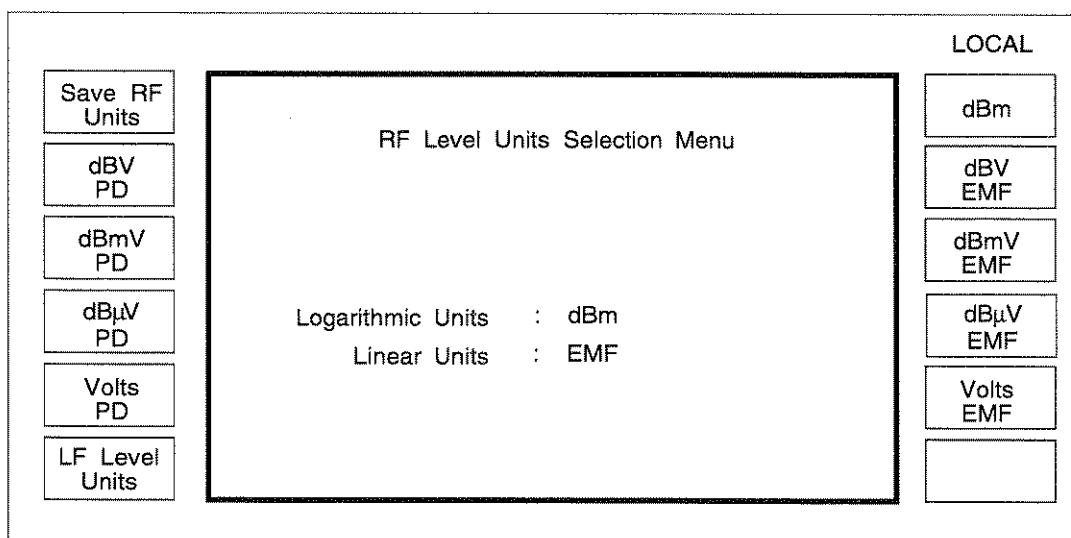

Fig. 3-1-75 RF level units selection menu (shown unlocked to level 1)

LF level units

LF level logarithmic units may be referenced to 1 volt EMF (dBV EMF), 1 millivolt EMF (dBmV EMF) or 1 milliwatt into 600 Ω (dBm). Linear units are always set EMF values.

Select the units by pressing the [LF Level Units] soft key on the RF Level Units Selection Menu which calls up the LF Level Units Selection Menu shown in Fig. 3-1-76.

To change the default LF level units shown at switch on, first unlock the instrument to Level 1. This causes an additional soft key to be displayed in the top left box (see Fig. 3-1-76). Select the required LF level units and press the additional [Save LF Units] key to save these as the default units.

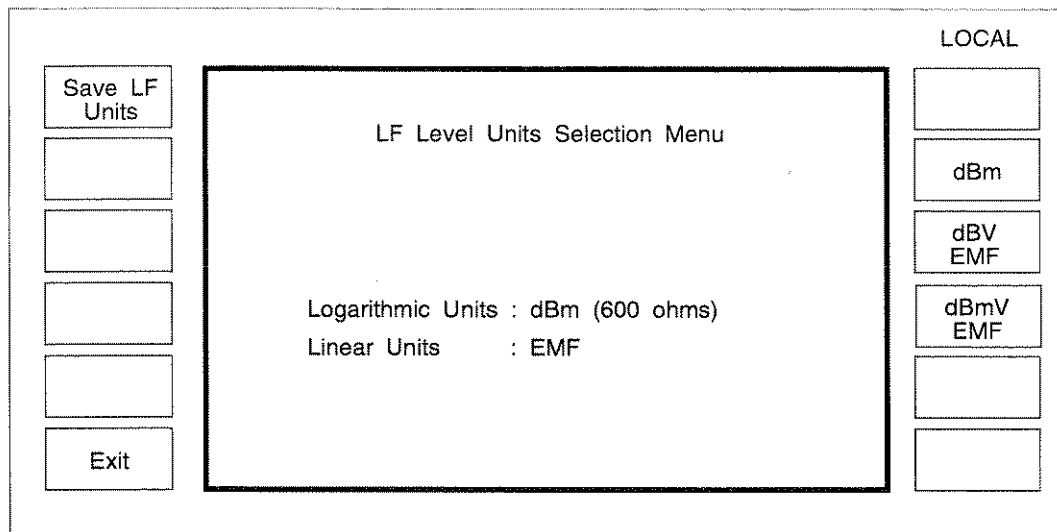

C0328

Fig. 3-1-76 LF level units selection menu (shown unlocked to level 1)

RF level utility

Selecting [RF Level Utility] from the *Utilities Selection Menu 2* displays the *RF Level Utility Menu* shown in Fig. 3-1-77.

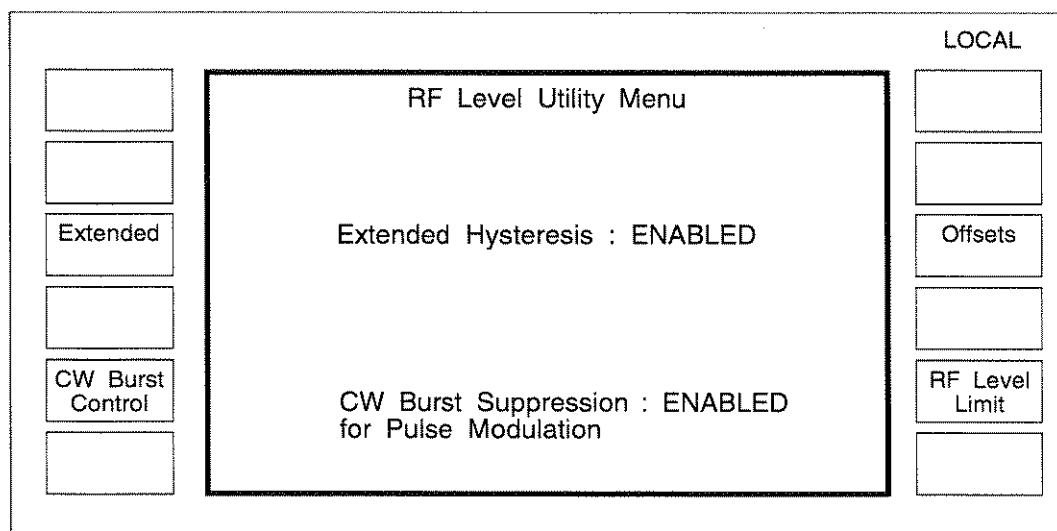

C1892

Fig. 3-1-77 RF level utility menu

Extended hysteresis

Pressing the [Extended] soft key toggles the status (Enable/Disable) of extended hysteresis. When enabled, this provides an electronic level function which uses the internal D/A converter, rather than the attenuators, to provide an uninterrupted (glitch-free) level control. This increases the electronic level control range to +12 to -18 dB. A +HYST or -HYST message is displayed on the *Sig Gen* menu to indicate when in hysteresis and in which direction.

During normal operation the RF output is controlled as shown in Fig. 3-1-78 by electronically controlling the output level over a limited range (normally approximately 0 to +6 dBm) and switching in 6 dB attenuator pads to provide lower RF levels.

When the hysteresis function is enabled and a keyboard entry of the RF level is made, the signal generator sets the level in the normal way. However, when the rotary control is enabled and used to adjust the RF level, the normal attenuator changes are suppressed. When the level is increased, the attenuator change is suppressed for 6 dB above the normal range and +*HYST* is displayed. Similarly, when the level is reduced attenuator changes are suppressed for 12 dB below the normal range and -*HYST* is displayed. When the extended hysteresis range is exceeded the attenuator and the electronic control are reset to values corresponding to the normal operation of the generator. An example of extended hysteresis operation is shown in Fig. 3-1-79.

With the rotary control in use in the hysteresis range of operation, the generator can be instructed to set the RF level to the same value, but set using the [V], [mV], [μ V] or [dB] keys. This is a useful facility if the user is investigating squelch systems and wants to ensure that varying the level around the current value will not result in an attenuator change.

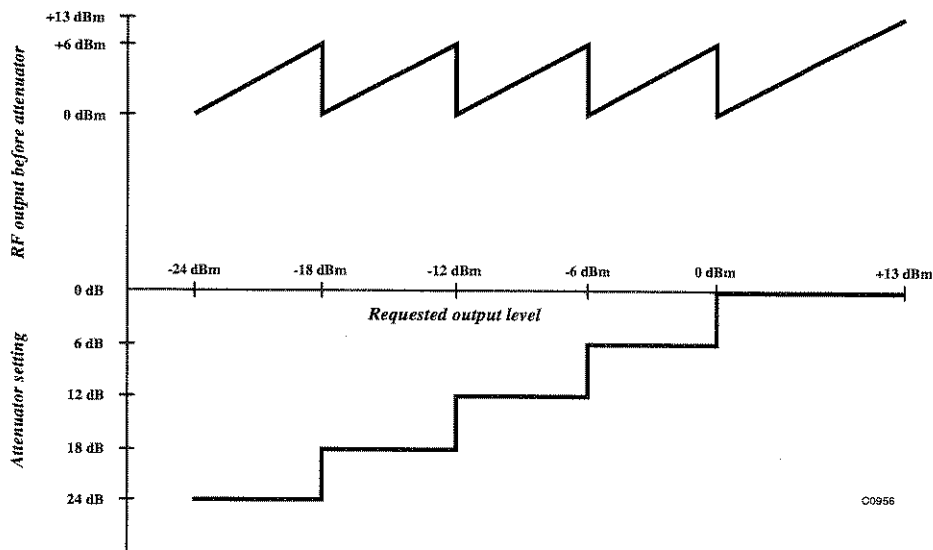

Fig. 3-1-78 Normal signal generator level control operation

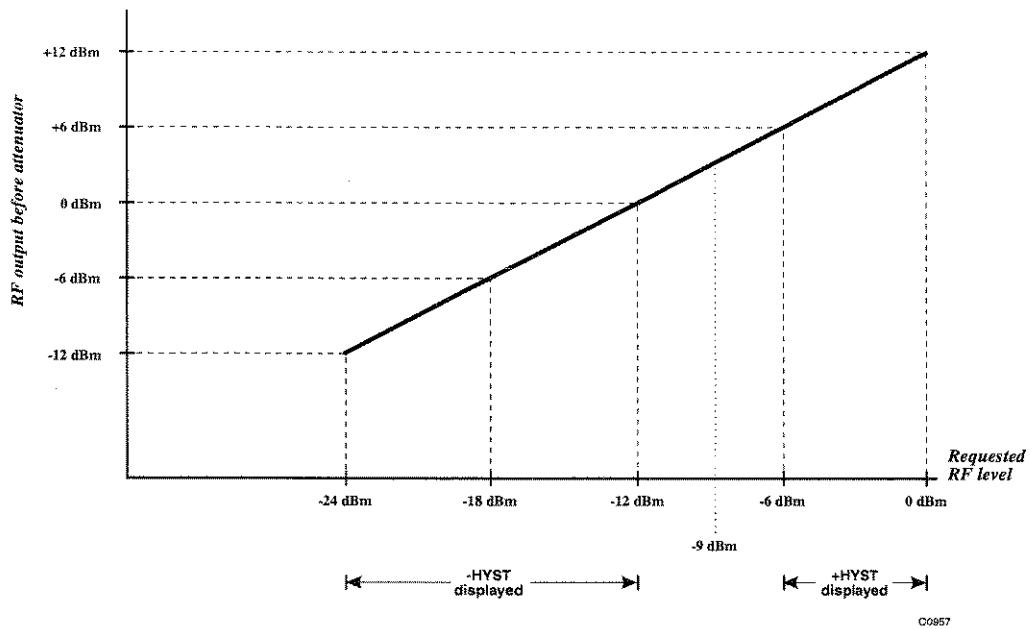

Fig. 3-1-79 Extended hysteresis operation with an RF level of -9 dBm as the starting level

Note...

In the hysteresis range the RF level is set in a different way to the normal operation and this will affect some performance aspects. AM distortion and accuracy will be affected. With no AM selected, the effect on RF accuracy in the +HYST region will be relatively minor. But the effect in the -HYST region on RF level accuracy will be more significant.

Burst control

Applies only if Option 002, Pulse Modulation is fitted. Pressing the [CW Burst Control] key toggles between normal operation and Burst Suppression operation. For details refer to 'Pulse modulation' above.

RF offset

With the instrument unlocked to Level 1, see 'Locking and unlocking' above, pressing [Offsets] produces the layout for the soft keys shown in Fig. 3-1-80.

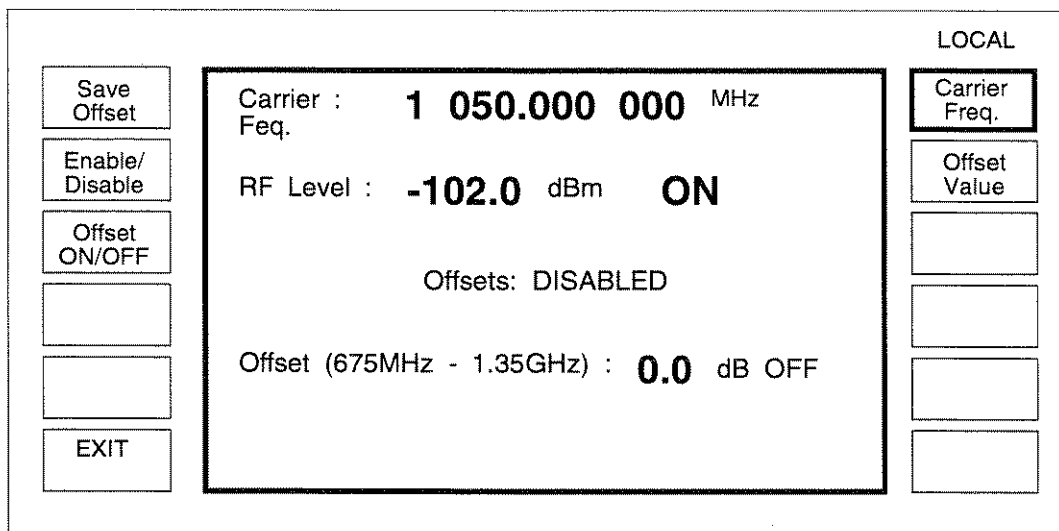

C1484

Fig. 3-1-80 RF offset adjustment menu

To compensate for cable or switching losses or to standardize a group of instruments so that they give identical measurements, the RF output level can be offset by up to ± 2 dB. This is done by selecting [Offset Value] and either keying in the value or making the adjustment with the control knob. A separate offset can be set for the carrier frequency range 10 kHz to 337.5 MHz and each octave above this. Offsets can be turned on or off individually using the [Offset ON/OFF] key or all offsets can be turned on or off via the [Enable/Disable] key.

Note...

This facility is replaced by a more versatile system on generators supplied with Option 008, RF profiles and complex sweep (see Annex B).

RF level limit

With the instrument unlocked to level 1, see 'Locking and unlocking' above, pressing the [RF Level Limit] key causes the RF Level Limit Menu shown in Fig. 3-1-81 to be displayed.

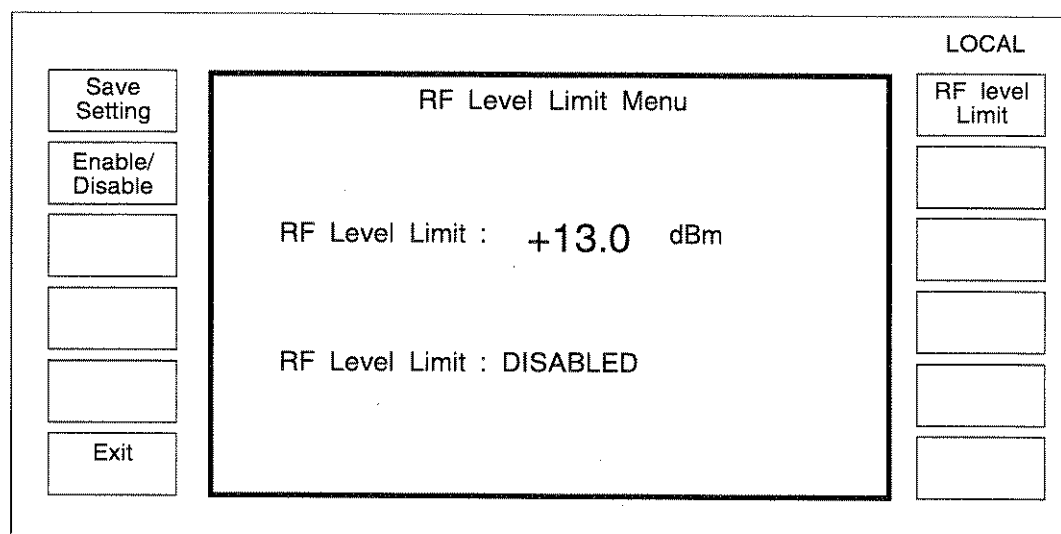

C1893

Fig. 3-1-81 RF level limit menu

The maximum peak RF level output can be specified in the range -138 to +19 dBm. As a result the keyed-in RF output value can be limited as a measure of protecting sensitive devices connected to the RF output of the signal generator. Alternatively, the RF output power can be extended by an additional 6 dB for overrange testing. If the requested output level is in the overrange region the *uncal* message is displayed on the *Sig Gen* menu.

The RF level limit is set by selecting [RF Level Limit] and entering the value required. Units may be μ V, mV or dB. The choice of volts EMF, volts PD and the dB reference is made by using the RF Level Units utility (see 'RF level units' above). The RF level limit can be turned on or off by means of the [Enable/Disable] key.

By pressing the [Save Setting] key, the RF level limit value and status is stored to non-volatile memory which is recalled at switch-on and during an instrument reset.

Note...

When in the overrange region, the signal generator is capable of generating much higher signal levels. If the frequency is set below 21.09375 MHz and the RF output is not terminated in 50 Ω , the RPP may be tripped by the internal RF signal. If this happens the RPP can only be reset if a 50 Ω termination is connected to the RF OUTPUT socket.

LOW FREQUENCY OPERATION

The instrument has two modes of LF operation. The LF output can be used either as a modulation signal monitor or as an independent low frequency generator. Pressing [LF] displays either the *LF Monitor Menu* or the *LF Generator Menu*, depending on which mode was last selected.

Note...

These modes are not available in digital and vector modulation since the connector is redirected for envelope control.

LF monitor

The left-hand side of the *LF Monitor Menu*, varies according to the modulation mode; single, composite, dual or dual composite. In each case the right-hand side is occupied by a single soft key, [*LF Gen.*].

**TABLE 3-1-1
LIST OF AVAILABLE SOFT KEYS FOR ANALOG MODULATION MODES**

Single	Composite	Dual	Dual Composite
Mod. Drive	Mod. Drive	AM Drive	AM Drive
Mod. Source	Mod. 1 Source	AM Source	AM 1 Source
-	Mod. 2 Source	-	AM 2 Source
-	-	FM/ Φ M Drive	FM/ Φ M Drive
-	-	FM/ Φ M Source	FM/ Φ M 1 Source
-	-		FM/ Φ M 2 Source

Modulation source monitoring

Internal sources only may be monitored. To monitor a modulating signal source, press the appropriate key. The source monitor level and the source information appear on the display. The modulating signal output is fed to the LF OUTPUT socket at a fixed level of 1 V.

Modulation drive monitoring

Modulation drive monitoring is intended for the user to monitor complex modulating signals from both internal and external sources. To monitor a modulation drive, press the appropriate key. The LF Monitor Level and the selected drive are displayed.

When the summed AM drive signal is selected, a signal which is the sum of both AM channels is fed to the LF OUTPUT socket, if in a composite or dual composite mode. The LF level function controls the output level at 100% depth, therefore the actual output voltage depends on the modulation depth. If AM is turned off, the associated LF output is removed.

The summed FM/ Φ M drive signal is also fed to the LF OUTPUT socket. The signal is the sum of both FM/ Φ M channels. The FM drive signal at the monitored point is nominally 1 V but varies over a range of approximately 3 dB (except at deviation values below about 1 kHz) depending on the set modulation and the carrier frequency selected. If FM/ Φ M is turned off, the LF signal is removed. If one component of a composite modulation setting is turned off, the component which is left on remains at its original level.

Note...

Wideband FM and pulse modulating signals are not accessible via the monitor mode.

Use as an independent LF generator

To use the instrument as an independent LF generator, select [LF Gen.] at the LF Monitor Menu. The LF Generator Menu appears on the display as shown in Fig. 3-1-82.

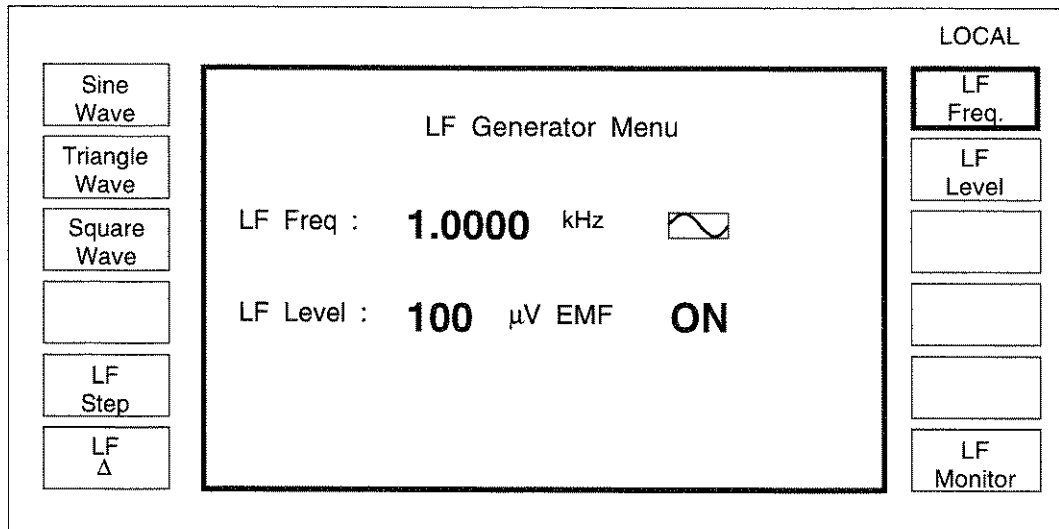

C4281

Fig. 3-1-82 LF generator menu

In this mode, one internal oscillator must be used exclusively for this task. Consequently if only one oscillator is fitted, no internal modulation is available to the signal generator while the LF generator is in use. If a second oscillator is fitted, only one is available to the signal generator.

LF frequency and LF level are adjusted by pressing the appropriate key and entering the value via the numerical key pad and pressing [enter]. To set step values, press [LF Step] for the LF Step Menu. [Freq. Step] or [Level Step] can be selected and the values entered as before. To display the LF Total Shift Menu, press [LF Δ].

To regain the oscillator as a modulation source, select the monitor mode.

Note...

The LF output is entered as V/mV/μV or dBm/dBV/dBmV representing the open circuit voltage fed to a high impedance, but the steps are entered in dB and the control knob has a fixed resolution of 0.1 dB.

MEMORY

Memory recall

Pressing the [MEM] hard key after switch on, causes the *Memory Recall Menu*, Fig. 3-1-83, to be displayed. There are four types of recall, full, partial, carrier frequency and sweep. Provision is made for an option not to recall the carrier frequency for full and partial stores. This allows one carrier frequency to be used with a series of stored settings. Pressing [*Inhibit ON/OFF*] turns the option ON and OFF. The state of the option is indicated on the display.

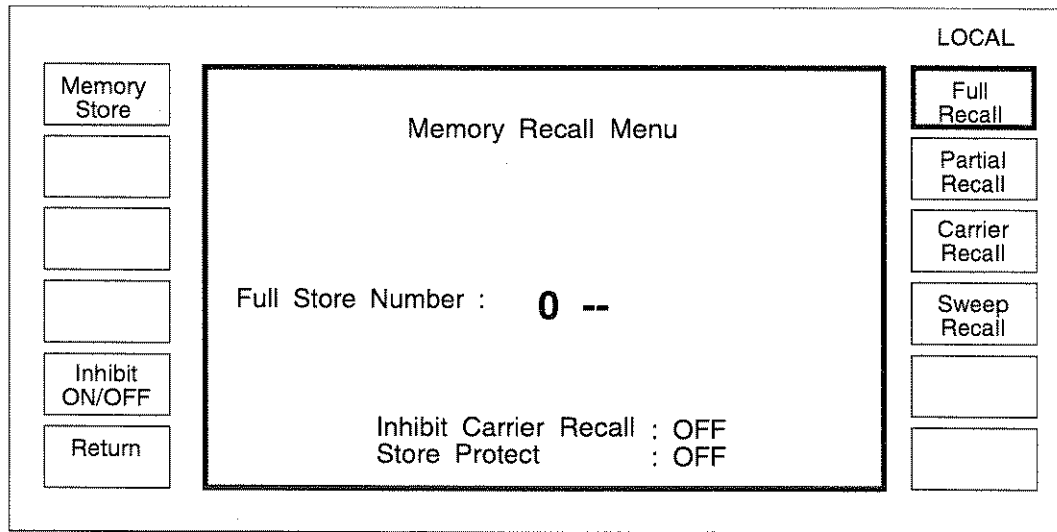

C0940

Fig. 3-1-83 Memory recall menu

Full recall

Selecting [*Full Recall*] enables the recall of a complete instrument setting, i.e. carrier frequency, RF level, modulations and their increments, ON/OFF and source information. Also recalled are all 6 modulation oscillator frequencies, plus one increment, and the LF Generator/Monitor setting. [*Inhibit ON/OFF*] provides the option not to recall the carrier frequency setting. The state of the option is indicated on the display. There are 50 locations (numbered 0 to 49) for full recall. A further location (50) allows the factory default settings to be recalled. The factory default settings are listed in Table 3-2-1.

Partial recall

This is a less comprehensive recall of only those parameters which currently affect the RF output; carrier frequency, RF level, modulations in use (without increments), ON/OFF and source information and the two modulation oscillator frequencies in use. As with full store, the option not to recall the carrier frequency is provided. There are 50 locations (numbered 0 to 49) for partial storage.

Carrier recall

The carrier frequency store has 100 locations (numbered 0 to 99) which may be recalled when required.

Sweep recall

The sweep store has 20 locations (numbered 0 to 19) containing complete sets of sweep parameters which may be recalled when required.

Note...

Sweep parameters can be recalled whether the instrument is in sweep mode or not. They are only used when sweep is selected.

Recalling data

To recall data, press the soft key for the type of recall required, e.g. [*Carrier Recall*] and select the location by means of the key pad. The [↑] and [↓] keys can be used to recall the next locations. Pressing [*Return*] recalls the location last specified on the numerical key pad.

Stores can be incremented or decremented externally by means of the SWEEP TRIGGER socket (see 'External trigger' above).

Note...

The settings for the sequential calling tones are recalled via the calling tones menu in UTILITIES, see Fig. 3-1-70. These stores can be erased from the *Store Erase Menu*.

Inhibit ON/OFF

When recalling full or partial stores it is sometimes useful for the existing carrier frequency setting to remain and not be replaced by the stored setting. The Inhibit Carrier Recall facility offers this capability. To prevent the current carrier frequency from being replaced use the [*Inhibit ON/OFF*] key to set the *Inhibit Carrier Recall* annunciator to *ON*.

To allow the carrier frequency setting to be overwritten use the [*Inhibit ON/OFF*] key to set the *Inhibit Carrier Recall* annunciator to *OFF*.

Memory stepping facility

The [Sig Gen] key has a toggle action in that pressing the key a second time displays the *Memory Stepping* menu shown in Fig. 3-1-84. This facility enables the memory to be stepped up and down from a start location (selected using the *Memory Recall Menu*), whilst displaying the settings for that memory.

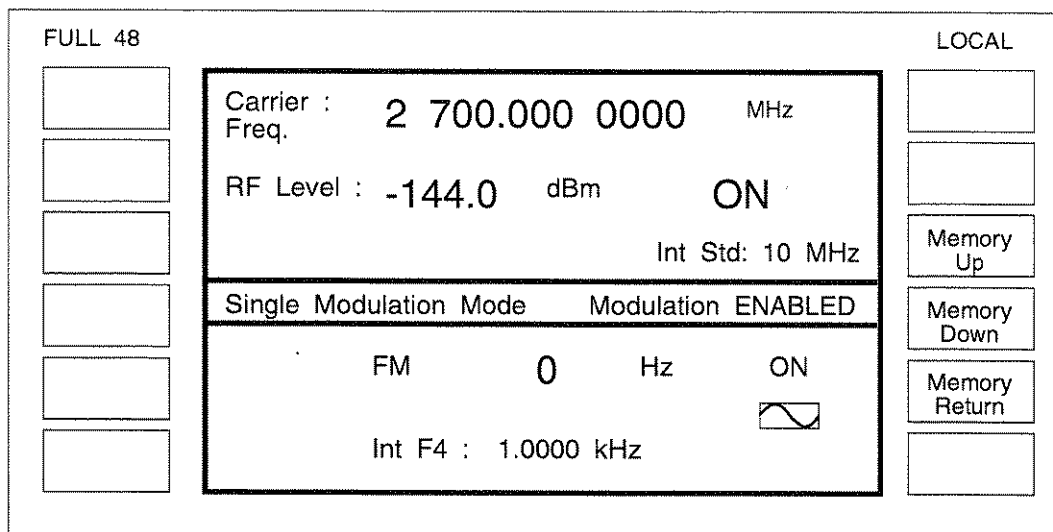

C0955

Fig. 3-1-84 Memory stepping menu

Pressing *[Memory Up]* or *[Memory Down]* respectively increments or decrements the memory location. With each step the settings stored in the location are displayed together with, at the top left of screen, the memory type and location e.g. *Full 48*. Incrementing and decrementing can also be done externally by means of the SWEEP TRIGGER socket (see 'External trigger' above). Pressing *[Memory Return]* at any time returns to the start location.

When a limit is reached, e.g. for Full Recall locations 0 and 49, a further step will reset to the start location. But note that if the start location coincides with a limit, trying to step past that limit will cause the limit and start locations (in this case the same numbered locations) to be alternately displayed. To make the user aware of this situation, the message *At Top Limit* or *At Bottom Limit* is displayed at the top centre of screen.

Memory store

Pressing the *[Memory Store]* soft key on the *Memory Recall Menu* causes the *Memory Store Menu*, Fig. 3-1-85, to be displayed. There are four types of store, full, partial, carrier frequency and sweep.

To prevent the accidental overwriting of memory contents, a store protection facility is provided. If this feature is enabled, the screen legend will indicate *Store Protect: ON* and the store key legends at the right of the screen will not appear.

Note...

Sequential calling tone sequences can be stored from the *Sequential Calling Tones Utility* menu. There is provision for storing up to 20 tone sequences.

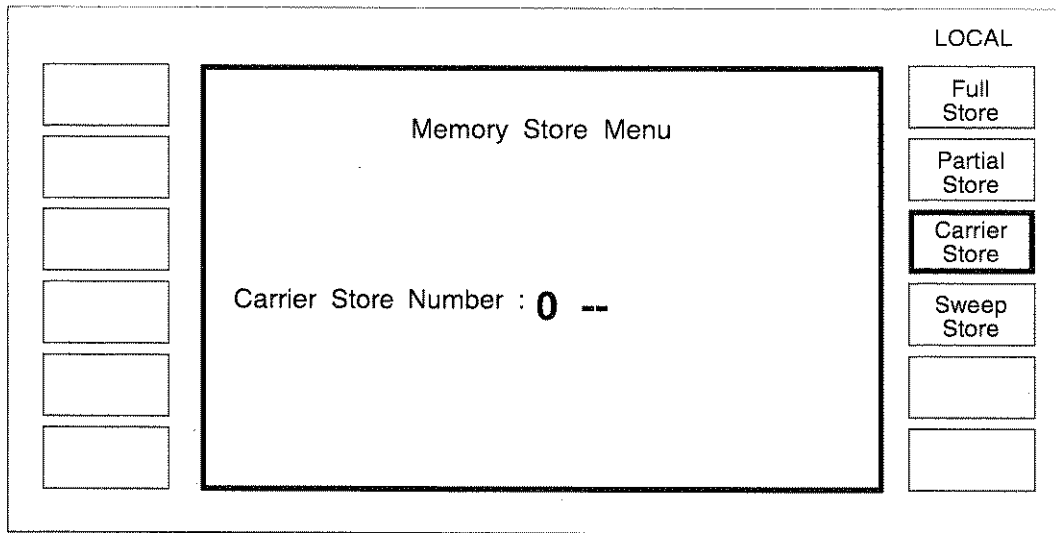

C0941

Fig. 3-1-85 Memory store menu

Full store

Selecting [*Full Store*] enables the storage of a complete instrument setting, i.e. carrier frequency, RF level, modulations and their increments, ON/OFF and source information. Also stored are all 6 modulation oscillator frequencies, plus one increment, and the LF Generator Monitor setting. There are 50 locations (numbered 0 to 49) for full storage. A further location (50) holds the factory default settings. This memory cannot be written to by the user. The factory default settings are listed in Table 3-2-1.

A Full Store contains the following information:

- Carrier frequency setting
- Carrier frequency step size
- RF level setting
- RF level step size
- All modulation settings
- All modulation step sizes
- Modulation mode and status
- All six internal oscillator frequency settings
- The modulation frequency step size
- LF generator frequency setting
- LF generator frequency step size
- LF generator level setting
- LF generator level step size
- LF monitor settings
- Display blanking settings

Note...

In digital and vector modes the parameters are stored in place of the analog modulation parameters.

Partial store

This is a less comprehensive store of only those parameters which currently affect the RF output; carrier frequency, RF level, modulations in use (without increments), ON/OFF and source information and the two modulation oscillator frequencies in use. There are 50 locations (numbered 0 to 49) for partial storage.

A Partial Store contains the following information:

- Carrier frequency setting
- RF level setting
- The active modulation settings
- Modulation mode and status
- The frequency of the active modulation frequencies
- Either the LF generator frequency and level setting or the LF monitor setting (depending on which mode is selected)

Note...

In digital and vector modes the parameters are stored in place of the analog modulation parameters.

Carrier store

The carrier frequency store has 100 locations (numbered 0 to 99) for the storage of carrier frequency only. This store can be used in conjunction with the full and partial stores to apply a set of test conditions to a range of frequencies.

Sweep store

The sweep store has 20 locations (numbered 0 to 19) for the storage of complete sets of sweep parameters.

Storing data

To store data, press the soft key for the type of store required, e.g. [*Partial Store*] and define a store location via the numerical key pad, then press [enter].

Note...

The settings for the sequential calling tones are stored via the calling tones menu in UTILITIES, see Fig. 3-1-70. These stores can be erased from the *Store Erase Menu*.

Store erase

Unlock to Level 1. Pressing [*Store Erase*] causes the *Store Erase Menu* to appear on the screen. The opportunity to erase all the stores of a given type is available by pressing the relevant key and then pressing [*Erase*].

Frequency hopping

Carrier frequency hopping is a GPIB operation where the instrument can be instructed to hop between any of the frequencies contained in the carrier frequency stores and a sequence of up to 1024 hops may be entered. The time interval between hops can also be entered.

Before executing a carrier hopping sequence, the frequencies must be loaded into the carrier frequency stores (0 - 99). This can be achieved via the GPIB using the following commands -

CFRQ < frequency value >
STO:CFRQ < store number >

To enter the frequency hopping mode, enter the following GPIB commands -

IMODE SWEEPER
SWEEP:TYPE HOP

This will cause the screen as shown in Fig. 3-1-86 to appear on the signal generator -

The screenshot shows a terminal window with a central display area and control buttons on the sides. The central display is titled "GPIB OPERATION ONLY !!!" and shows the following information:

- Step Time: 50 ms
- Sweep Status: WAITING FOR TRIGGER
- Sweep Mode: INTERNAL SINGLE
- Sweep Type: CARRIER HOPPING

On the left side, there are six empty rectangular boxes. On the right side, there is a "REMOTE" section with a "Go To Local" button and five empty rectangular boxes. The identifier "C0067" is located at the bottom right of the terminal window.

Fig. 3-1-86 Frequency hopping menu

To load in a sequence, the following command is used -

HOPSEQ<n0>,<n1>,<n2>,<n3>,<n4>.....

where <n0> - <n> are numeric values in the range 0-99 corresponding to the carrier frequency store at which the necessary frequency is stored. The hopping sequence length is determined by the amount of numbers entered.

The other parameter that can be set to control the hopping sequence is the time between steps. This is done using the command -

SWEEP:HOP:TIME < t >

where t represents the number of milliseconds.

The 100 frequencies are precalculated and loaded into a software sweep table using the GPIB command -

SWEEP:CALC

Note...

If any of the carrier frequency stores have become corrupt and so result in a checksum error, the following message will appear in the centre of the screen -

**CARRIER STORE < x > CORRUPTED.
RE - ENTER FREQUENCY.**

where x is the corrupted store number.

With the frequencies, sequence and step time loaded, the hopping operation is controlled in the same manner as the ordinary sweeps by using the following commands -

SWEEP:GO	starts the hopping sequence (and will do any precalculation if required).
SWEEP:HALT	pause the hopping sequence.
SWEEP:UP	go up to the next step while paused.
SWEEP:DN	go down to previous step while paused.
SWEEP:CONT	continue hopping sequence.
SWEEP:RESET	reset sequence to start value.

When paused the carrier store number is displayed on the screen.

Note...

There are no markers available and the operation of transferring the paused value to the main parameter is not permitted.

To enter a new sequence use the HOPSEQ command but the number 255 is inserted at the beginning of the string.

e.g. existing sequence - 0, 6, 53, 72, 43, 96
sequence required - 22, 16, 7, 41, 59, 66
send GPIB command -
HOPSEQ 255, 22, 16, 7, 41, 59, 66

To add to an existing sequence use the HOPSEQ command without 255 at the beginning of the string.

e.g. existing sequence - 12, 24, 36, 48
sequence required - 12, 24, 36, 48, 60, 72, 84
send GPIB command -
HOPSEQ 60, 72, 84

To determine the length of the hopping sequence the following GPIB command is used -

HOPSEQ?

This returns a value 1 - 1024.

Like other sweep settings the frequency hopping mode can be set to -

single sweep (internal trigger),
continuous sweep (internal trigger) or
external sweep (external trigger)

by using the following commands -

SWEEP:MODE SNGL
SWEEP:MODE CONT
SWEEP:MODE EXT

For externally triggered operation the trigger facility can be used in the same manner as another sweep function.

ERROR HANDLING

Errors may be divided into three groups - foreground errors generally caused by a user, background errors which represent a condition of the instrument and GPIB errors which occur only when the unit is being controlled by a GPIB controller.

Background errors

An incorrect operating condition within the instrument automatically generates an error message to warn the operator. For example, if the internal frequency standard should fail the message *Int. Standard Failure* will be displayed at the top of the screen. Background errors are listed in Table 3-2.

Foreground errors

Attempts to set the instrument to a parameter value outside its known range result in the generation of an error message. For example, trying to select a carrier frequency above or below the specified range results in the message *Carrier Outside Limits* being displayed at the top of the screen. Foreground errors are cleared automatically when a correct entry is made by the user. Foreground errors are listed in Table 3-3.

GPIB errors

Errors caused by incorrect programming are displayed at the top of the screen and may also generate a Service Request if the relevant status registers are set. GPIB errors are listed in Table 3-4.

Error display

Front panel

Errors are displayed as a single line of text at the top of the screen. If more than one error is present an internal priority ordering algorithm determines which error is displayed.

GPIB

When an error occurs, its number is entered into the Error Queue. Errors are not removed from the queue when they are cleared, but only by the ERROR? query, which returns the error at the head of the queue, or by the *CLS command which clears the whole queue. When the queue contains an error entry, a bit (<erb>) on the status byte is set.

The error queue has a capacity of 100 error numbers. If an error occurs while the queue is full the last error number is replaced with 255 so that the ERROR? query returns a value of 255 to indicate a full queue. An empty queue returns a value of 0 following an ERROR? query.

In addition to the error queue entry, the appropriate bit in the Standard Event Register will also be set (one of <cmd>, <exe>, <dde> or <qye>). Many background errors are also reported in the Hardware and Coupling Status Registers. For the above registers see Chap. 3-2.

TABLE 3-1-2 BACKGROUND ERRORS

Error		Descriptive text	Error		Descriptive text
No.	Type		No.	Type	
1	dde	RPP Tripped	6	dde	VCXO Out of Lock
2	dde	Fractional N Out of Lock	7	dde	Ext1 Too Low
3	dde	Int. Standard Failure	8	dde	Ext1 Too High
4	dde	Ext. Standard Failure	9	dde	Ext2 Too Low
5	dde	Incorrect Ext. Standard	10	dde	Ext2 Too High
11	dde	IF Loop Out of Lock	16	-	-
12	dde	IQ Mod. Freq. Std. Failure	17	exe	RF Level limited by AM
13	dde	16/26 Reference Too High	18	exe	FM limited by Carrier
14	dde	16/26 Reference Too Low	19	exe	WBFM limited by Carrier
15	dde	IQ MOD. AUTOCAL REQUIRED	20	exe	AM2 limited by AM1
21	exe	FM2 limited by FM1	26	dde	Real Time Clock Problem
22	exe	PM2 limited by PM1	27	dde	Calibration Date Expired
23	exe	Steps limited by Span	28	dde	Pad Calibration Checksum
24	exe	FM Selfcal Error	29	dde	RF Calibration Checksum
25	dde	Internal Osc.1 Missing	30	dde	FM Calibration Checksum
31	dde	Path/Source Calibration	36	-	-
32	dde	Absolute Mod. Calibration	37	-	-
33	dde	Freq. Std. Calibration	38	-	-
34	dde	IQ MOD. RF Calibration	39	-	-
35	dde	IQ Modulator Calibration	40	exe	Profile Outside RF Limits
41	dde	Incorrect Software Fitted			
42	exe	RF Lvl. Limited by IQ Mode			
43	exe	S'band Sel. Not Possible			
44	exe	IF Selection Not Possible			
45	exe	Carr. Limited by IQ Mode			

TABLE 3-1-3 FOREGROUND ERRORS

Error		Descriptive text	Error		Descriptive text
No.	Type		No.	Type	
46	exe	Recall Checksum	51	exe	Carrier Outside Limits
47	exe	Incorrect Setup	52	exe	RF Level Outside Limits
48	exe	Invalid Memory Number	53	exe	Mod Rate Outside Limits
49	exe	MODULATION NOT ENABLED	54	exe	LF Freq. Outside Limits
50	exe	Out of Range	55	exe	LF Level Outside Limits
56	exe	AM Outside Limits	61	exe	RF Level Step Too Big
57	exe	FM Outside Limits	62	exe	Mod Rate Step Too Big
58	exe	PM Outside Limits	63	exe	LF Freq. Step Too Big
59	exe	WBFM Outside Limits	64	exe	LF Level Step Too Big
60	exe	Carrier Step Too Big	65	exe	AM Step Too Big
66	exe	FM Step Too Big	71	exe	Sweep Stop Out of Range
67	exe	PM Step Too Big	72	exe	Sweep Steps Out of Range
68	exe	Invalid Latch Number	73	exe	Sweep Time Out of Range
69	exe	Invalid Latch Data	74	exe	Sweep Marker Out of Range
70	exe	Sweep Start Out of Range	75	exe	Attenuator EAROM Read

TABLE 3-1-3 FOREGROUND ERRORS (continued)

76	exe	Attenuator EAROM Write	81	exe	EAROM Wrap Around Error
77	exe	RF Option Box EAROM Read	82	exe	Continuous Tone Checksum
78	exe	RF Option Box EAROM Write	83	exe	Sequential Tone Checksum
79	exe	EAROM Write Error	84	exe	Tone data Out of Range
80	exe	EAROM Read Error	85	exe	Tone Offset Out of Range
86	exe	Clock Data Entry Error	91	exe	RF levelling fault
87	exe	At Top Limit	92	exe	REPEAT THIS CALIBRATION
88	exe	At Bottom Limit	93	exe	DSP Not Responding
89	exe	Ext. Trigger Disabled	94	exe	A/D Conversion Failure
90	dde	Int. Std. Not Selected	95	exe	Tone Sequence Incorrect
96	exe	Mod. Autocal Failure			
97	-	-			
98	exe	Direct Doppler Limited			
99	exe	Insufficient Points			
100	exe	Carrier Outside Profile			

TABLE 3-1-4 GPIB ERRORS

Error		Descriptive text	Error		Descriptive text
No.	Type		No.	Type	
101	-	-	106	cmd	Data Expected
102	cmd	Mnemonic Fault	107	cmd	Illegal Data
103	cmd	Block Definition	108	cmd	Terminator Expected
104	cmd	Block Size	109	cmd	GET Error
105	cmd	Numeric Syntax	110	cmd	EOM Error
111	exe	Illegal Modulation Mode	116	qye	Unterminated
112	exe	No Such Monitor Mode	117	qye	Interrupted
113	exe	Cannot Monitor	118	qye	Deadlock
114	exe	Instrument Mode Wrong	119	cmd	Missing Quote
115	cmd	Lost Data After Comma	120	cmd	Terminator Expected
121	exe	String Length	126	exe	Illegal Seq Tones Mode
122	exe	Illegal Tone Character	127	exe	Overflow
123	exe	Illegal Duration Char	128	cmd	Data Too Long
124	exe	Illegal Standard	129	exe	Voltage Type Error
125	exe	Illegal Save Destination	130	exe	Sweep Not Possible
131	exe	Unknown Cal Point	136	exe	Unknown Freq. Standard.
132	exe	Unknown RF Band	137	exe	User Data Locked
133	exe	Unknown Instrument Mode	138	exe	Trigger Unknown
134	exe	User Data Checksum	139	exe	Illegal Tones Operation
135	qye	Query Lost after arb. char	140	cmd	Error in Char Data
141	exe	Wrong RF units	146	exe	Wrong Family For Command
142	cmd	Data Unknown	147	exe	Not Suitable For Hopping
143	exe	Negative Value Illegal	148	exe	Hopping Sequence Full
144	exe	Illegal Modulation Mode	149	-	-
145	exe	Unavailable Mod Source	150	exe	Wrong LF Units
151	-	-	156	exe	Text Tone Util. Selected
152	-	-	157	exe	Illegal Sequence Char.
153	-	-	158	exe	Point not in Profile
154	exe	Unknown Waveform ROM Type	159	exe	Unkown External Box Type
155	exe	IQ Mode Parameter Unkown	160	-	-

TABLE 3-1-5 FATAL ERRORS

Error		Descriptive text	Error		Descriptive text
No.	Type		No.	Type	
171	exe	Main RAM Faulty	176	-	-
172	exe	Main PROM Faulty	177	-	-
173	exe	Microwave Board Error	178	-	-
174	exe	Attenuator Type Unknown	179	-	-
175	exe	Wrong Attenuator fitted	180	-	-

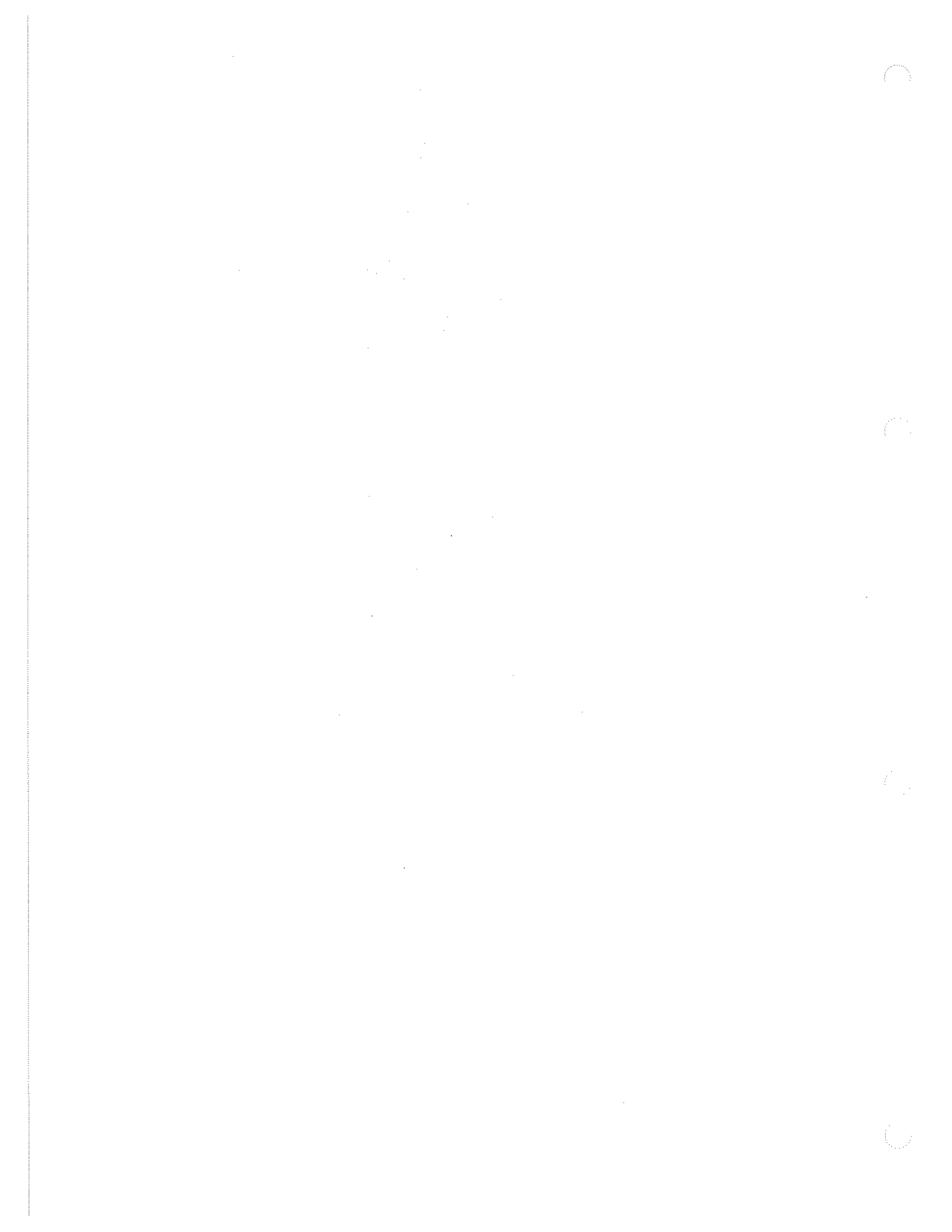

Chapter 3-2

GPIB OPERATION

CONTENTS

	PAGE
INTRODUCTION	3-2-2
GPIB FUNCTIONS.....	3-2-2
DEVICE LISTENING ELEMENTS	3-2-3
DEVICE TALKING ELEMENTS.....	3-2-3
PROGRAMMING.....	3-2-4
Program messages.....	3-2-4
Compound headers.....	3-2-4
Program data.....	3-2-5
Message exchange protocol.....	3-2-5
Remote/local operation	3-2-5
Common commands and queries (IEEE 488.2)	3-2-6
DEVICE DEPENDENT COMMANDS.....	3-2-8
DEFAULT SETTINGS	3-2-8
INSTRUMENT MODE.....	3-2-10
CARRIER FREQUENCY	3-2-10
RF LEVEL.....	3-2-11
MODULATION MODE.....	3-2-14
MODULATION CONTROL.....	3-2-15
DIGITAL MODULATION.....	3-2-16
VECTOR MODULATION.....	3-2-26
FREQUENCY MODULATION.....	3-2-29
PHASE MODULATION.....	3-2-30
AMPLITUDE MODULATION.....	3-2-31
WIDEBAND FM	3-2-32
PULSE MODULATION	3-2-33
MODULATION FREQUENCY.....	3-2-34
CTCSS TONES EDIT.....	3-2-36
SEQUENTIAL TONES.....	3-2-37
LF CONTROL	3-2-41
LF GENERATOR FREQUENCY	3-2-42
LF GENERATOR LEVEL.....	3-2-43
MEMORY - STORE	3-2-44
MEMORY - RECALL	3-2-44
MEMORY - ERASE	3-2-44
SWEEP OPERATION.....	3-2-44
SWEEP MODE/TYPE	3-2-48
SWEEP CONTROL	3-2-49
MISCELLANEOUS COMMANDS	3-2-51
THE STATUS BYTE.....	3-2-54
STATUS DATA STRUCTURE - REGISTER MODEL.....	3-2-55
STANDARD EVENT REGISTERS.....	3-2-57
HARDWARE EVENT REGISTERS.....	3-2-58
COUPLING EVENT REGISTERS	3-2-59
INSTRUMENT EVENT REGISTERS	3-2-60
QUEUE FLAG DETAILS	3-2-61
STATUS BYTE WHEN READ BY *STB?	3-2-62
STATUS BYTE WHEN READ BY SERIAL POLL	3-2-63
SUMMARY OF STATUS REPORTING COMMANDS AND QUERIES	3-2-64

LIST OF TABLES

Table 3-2-1 INSTRUMENT DEFAULT SETTINGS.....	3-2-8
--	-------

INTRODUCTION

The 2050 Series signal generators can be operated remotely from a personal computer fitted with a GPIB interface card or a dedicated GPIB controller. All functions can be controlled by coded messages sent over the interface bus via the 24 way socket on the rear panel of the instrument. IEEE Standard 488.2 (1987) is implemented, which defines the protocols and syntax of commands. The 2050 Series commands are compatible with 2030 Series signal generators.

The instrument can function either as a talker or a listener. In the listen mode, it will respond to IEEE 488.2 common commands and queries and device-specific commands and queries. These allow various device functions to be controlled and operating parameters to be set. In the talk mode, device status information and parameter settings can be read from the instrument.

For full information on the IEEE protocols and syntax the IEEE 488.2 Standard should be consulted.

GPIB FUNCTIONS

The IEEE 488.1 interface functions offered by 2050 Series are as follows:

Source handshake (SH1)	complete capability.
Acceptor handshake (AH1)	complete capability.
Talker (T6)	basic talker, serial poll, unaddress if MLA.
Listener (L4)	basic listener, unaddress if MTA.
Service Request (SR1)	complete capability.
Remote/Local (RL1)	complete capability.
Device clear (DC1)	complete capability.
Device trigger (DT1)	complete capability.
Parallel Poll (PP0)	no capability.
Controller (C0)	no capability.
Tri-state drivers (E2)	as opposed to open collector drivers.

DEVICE LISTENING ELEMENTS

The following is a list of the device listening elements (as defined in the IEEE 488.2 standard) which are used in the 2050 Series of signal generators:

- <PROGRAM MESSAGE>
- <PROGRAM MESSAGE TERMINATOR>
- <PROGRAM MESSAGE UNIT>
- <PROGRAM MESSAGE UNIT SEPARATOR>
- <COMMAND MESSAGE UNIT>
- <QUERY MESSAGE UNIT>
- <COMPOUND COMMAND PROGRAM HEADER>
- <COMPOUND QUERY PROGRAM HEADER>
- <PROGRAM HEADER SEPARATOR>
- <PROGRAM DATA>
- <PROGRAM DATA SEPARATOR>
- <DECIMAL NUMERIC PROGRAM DATA>
- <CHARACTER PROGRAM DATA>
- <SUFFIX PROGRAM DATA>
- <STRING PROGRAM DATA>
- <ARBITRARY BLOCK PROGRAM DATA>

DEVICE TALKING ELEMENTS

The following is a list of the device talking elements (as defined in the IEEE 488.2 standard) which are used in the 2050 Series of signal generators:

- <RESPONSE MESSAGE>
- <RESPONSE MESSAGE TERMINATOR>
- <RESPONSE MESSAGE UNIT>
- <RESPONSE MESSAGE UNIT SEPARATOR>
- <COMPOUND RESPONSE HEADER>
- <RESPONSE HEADER SEPARATOR>
- <RESPONSE DATA>
- <RESPONSE DATA SEPARATOR>
- <NR1 NUMERIC RESPONSE DATA>
- <NR2 NUMERIC RESPONSE DATA>
- <ARBITRARY ASCII RESPONSE DATA>
- <CHARACTER RESPONSE DATA>
- <STRING RESPONSE DATA>
- <DEFINITE LENGTH ARBITRARY BLOCK RESPONSE DATA>

PROGRAMMING

Program messages

A message consists of one or more message units. Message units are separated by a semi-colon (;). The whole message is ended by the Program Message Terminator (or End Of Message) defined as one of the following:

- (1) <newline> (ASCII 10 - often known as 'line feed') or
- (2) <newline> + END (the EOI line is asserted as well) or
- (3) + END (EOI is asserted in the last data byte of the message)

Note ...

A response message is always terminated by <EOM> consisting of <newline> + END.

A message unit consists of a mnemonic header which may be followed by data. If data follows, then it must be separated from its header by at least one space

<header><SPACE><data>
e.g. RFLV:INC 6.0 dB

Spaces may be freely inserted in a message to improve readability, except within a header or within data.

A header may be a command or a query. A query has a '?' as its final character and causes the generation of a response message which will be read by the controller. Common commands and queries (defined in IEEE 488.2) begin with a '*'.

Upper and lower case characters are considered equivalent (i.e. FM fm Fm fM are all interpreted by the 2050 Series in the same way).

Compound headers

The 2050 Series implements compound headers which allow a complex set of commands to be built up from a small set of basic elements in a 'tree and branch' structure. The elements of a compound header are separated by a colon (:). Spaces are not allowed within a header.

Special rules apply when more than one compound header is used in one message. When the separator ';' is encountered, all headers except the trailing element of the previous header in the message are assumed to precede the following header, for example:

AM:DEPTH 30PCT;ON

is equivalent to the two commands:

AM:DEPTH 30PCT
and AM:ON

This does not apply to common commands (*RST etc.). The rule may be overridden by preceding a header with a colon, for example:

AM:ON::FM:ON

Most main functions have a short form of header which may be used for clarity and brevity in simple messages, for example:

CFRQ 1.25GHZ is the same as CFRQ:VALUE 1.25GHZ

Program data

Data can take many forms, as follows:

Decimal Numeric Data is a flexible numeric format which encompasses integer, fixed point and floating point (mantissa and exponent) representations. Data is rounded to a resolution appropriate to the function. Decimal data can, in most cases, be followed by the appropriate units. If no units are present, the specified default units are assumed.

Character Data is an alphanumeric word.

String Data consists of a number of 7-bit ASCII characters enclosed in quotes, either a pair of single ('ASCII 39') or double ("ASCII 34") quotes may be used.

Block Data is used by *PUD and allows a number of 8-bit bytes to be transferred. For further information see the Service Manual.

Some commands can accept Multiple Data items which are separated by commas, for example MODE FM,AM.

Message exchange protocol

The controller should not attempt to read a response until it has sent the entire query message (terminated by EOM). Also, it should not start to send a new message until it has read the entire response (terminated by EOM). The query message may contain more than one query message unit, but only one response message (containing several response message units) is generated.

Failure to follow the protocol will generate a query error:

UNTERMINATED (error 116) occurs when the controller attempts to read a response without having sent a query.

INTERRUPTED (error 117) occurs when the controller starts to send a new message before having read the response to a preceding query.

DEADLOCK (error 118) can only occur if the input and output buffers are both filled by the controller having sent an extra long Message containing several query message units.

The 2050 Series have input buffer stores of 256 characters and an output buffer of two response message units.

Remote/local operation

When the 2050 Series Signal Generator is addressed by the controller it will enter its remote mode and the screen will have only one key legend, *[LOCAL]*. Pressing this key returns the unit to normal manual operation, unless Local Lockout has been asserted by the controller.

Common commands and queries (IEEE 488.2)

The IEEE 488.2 standard defines a set of common commands and queries which implement common system functions.

Common command and query mnemonics are preceded by an asterisk (*) to distinguish them from device dependent data such as instrument programming strings. The following common commands and queries are implemented in the 2050 Series:

Mnemonic	Name and Description
*IDN?	Identification Query. Returns an arbitrary ASCII response comprising four data fields in the format: <Manufacturer>,<type number>,<serial number>,<firmware version number><EOM>. Example: IFR,2051,123456789,2.001<EOM>
*OPT?	Option Identification Query. Returns an arbitrary ASCII response containing a data field for each fitted option in the format: <option a>,<option d>, ... ,<option n><EOM> Example: SECOND OSCILLATOR,PULSE MODULATION,+19 dBm OUTPUT<EOM> If no options are fitted, ASCII '0' is returned
Note...	Because an Arbitrary ASCII Response ends with the Response Message Terminator (<EOM>) either *IDN? or *OPT? must be the last Query Message Unit in a Program Message.
*RST	Reset Command. Sets the instrument functions to the factory default power up state. The default settings appear in Table 3-2-1.
*TST?	Self Test Query. Returns a '0' when the GPIB interface and processor are operating.
*OPC	Operation Complete Command. Sets the Operation Complete bit in the Standard Event Status Register when execution of the preceding operation is complete.
*OPC?	Operation Complete Query. Returns a '1' when the preceding operation has been completed.
*WAI	Wait to Continue Command. Inhibits execution of an overlapped command until the execution of the preceding operation has been completed.
*TRG	Trigger Command. Equivalent to Group Execute Trigger.

- *PUD <block> Protected User Data Command. Sets the Protected User Data, accepts Definite Block Data when enabled. This command is covered in further detail in the Service Manual.
- *PUD? Protected User Data Query. Returns the User Data as a Definite Block Response.
- Example: #221Inventory Number 1234
- *STB? Read Status Byte Query. Returns the value of the Status Byte as an nr1 number (0-255).
- *SRE <nrf> Service Request Enable Command. Sets the Service Request Enable Register.
- *SRE? Service Request Enable Query. Returns the value of the Service Request Enable Register as nr1.
- *ESR? Standard Event Status Register Query. Returns the value of the Status Event Status Register as nr1.
- *ESE <nrf> Standard Event Status Enable Command. Sets the Standard Event Enable Register.
- *ESE? Standard Event Status Enable Query. Returns the value of the Standard Event Status Enable Register as nr1.
- *CLS Clear Status Command. Clears all the Status Event registers and clears the Error Queue. Does not affect the Enable Registers.

Note...

The IEEE 488.2 Device Clear function only affects the GPIB functions. The input and output buffers are cleared and the instrument put into a state to accept new Messages. It no longer puts the instrument functions into a defined state, this is now performed by the *RST common command.

DEVICE DEPENDENT COMMANDS

The following list describes the features of the device dependent mnemonics for the 2050 Series signal generators together with simple examples of their use within each major section (Carrier frequency, RF level, etc.) the root mnemonic is listed first followed by the lower level mnemonics. Each group is followed by a list of requirements for data type and suffix.

In addition to the normal listen commands the 2050 Series accept query commands which cause the instrument to prepare a message which will be sent to the controller when the instrument is next addressed to talk. For each query an example of a response is given. Where responses are similar for a group of queries not all are listed. Some queries can produce more than one type of response - an example of each is usually given.

In the list which follows, the abbreviations <char>, <nrf> and <str> have the following meanings:

<char> = Character Program Data
<nrf> = Decimal Numeric Program Data
<str> = String Program Data

Where the data format is Decimal Numeric Program Data, the value may be expressed as a signed or unsigned number in any of the following formats:

nr1: Decimal integer, e.g. 1234 or -567
nr2: Floating point number, e.g. 1.234 or -56.789
nr3: Floating point number with exponent, e.g. 1.2345E5 or -12.47E-8

DEFAULT SETTINGS

These are the settings assigned to instrument functions in the following cases:

- (i) Power-up to factory default settings.
- (ii) Execution of *RST command.
- (iii) Recall Full Store 50.

The instrument functions set to the factory default power-up state by the reset command (*RST) are as shown in Table 3-2-1.

TABLE 3-2-1 INSTRUMENT DEFAULT SETTINGS

Instrument mode	:	Normal
Carrier frequency	:	(Maximum available) 1.35 GHz/2.7 GHz/5.4 GHz
Step	:	1 kHz
RF level	:	-144 dBm
Step	:	1 dB
Status	:	ON
Modulation mode	:	Single FM , modulation enabled

TABLE 3-2-1 INSTRUMENT DEFAULT SETTINGS (continued)

Modulations:	FM1	:	0 Hz, Int F4, ON
	FM2	:	0 Hz, Ext 1 ALC, ON
	Φ M1	:	0 rad, Int F4, ON
	Φ M2	:	0 rad, Ext 1 ALC, ON
	AM1	:	0%, Int F4, ON
	AM2	:	0%, Ext 2 ALC, ON
	WBFM	:	(Minimum setting), AC coupled, ON
Steps:	Δ FM	:	1 kHz, Δ Φ M 0.1 rad, Δ AM 1%
Modulation source:	IntF1	:	300 Hz sine
	IntF2	:	400 Hz sine
	IntF3	:	500 Hz sine
	IntF4	:	1 kHz sine
	IntF5	:	3 kHz sine
	IntF6	:	6 kHz sine
Steps:		:	1 kHz
LF:	Mode	:	Monitor, mod source
LF generator:	Frequency	:	1 kHz sine, step 1 kHz
	Level	:	100 μ V
	Step	:	1 dB
	Status	:	ON
Sweep:			
	Type:	:	RF level
	Mode:	:	Single internal
RF level sweep :			
	Start:	:	-144 dBm
	Stop:	:	10 dBm
	Steps:	:	100
	Time:	:	50 ms
	Markers:	:	2, 4, 6, 8, 10 dBm, disabled
Carrier freq sweep			
	Start:	:	100 MHz
	Stop:	:	(Maximum available)
	Steps:	:	250
	Time:	:	50 ms
	Markers:	:	200, 400, 600, 800, 1000 MHz, disabled
Mod source freq:			
	Start:	:	0.1 Hz
	Stop:	:	500 kHz
	Steps:	:	10,000
	Time:	:	500 ms
	Markers:	:	100, 20, 30, 400, 500 kHz
Sequential tones:			
	Mode:	:	No modulation selected
	Standard:	:	CCIR
	Sequence:	:	16 Tone Fs
	Duration:	:	All normal
	Frequency offset:	:	0
	Extended duration:	:	500 ms
	Repeat tone:	:	E
	Start delay:	:	200 ms

INSTRUMENT MODE

IMODE Select instrument mode

Data type : Character Program Data (either NORMAL for signal generator operation or SWEEPER for swept operation)

Allowed suffices : None

Default suffix : None

Example: IMODE NORMAL

CARRIER FREQUENCY

CFRQ Set Carrier Frequency (short form)

:VALUE Set Carrier Frequency

:INC Set Carrier Frequency step

Data type : Decimal Numeric Program Data

Allowed suffices : Any one of: GHZ, MHZ, KHZ or HZ

Default suffix : HZ

:UP Go UP one step

:DN Go DOWN one step

:RET Return to original setting

:XFER Transfer current value to be the new setting

Data type : None

Allowed suffices : None

Default suffix : None

:PHASE Adjust Phase of Carrier in steps of $\pi/128$ radians (approximately 1.4°) over a range of ± 255 steps

Data type : Decimal Numeric Program Data

Allowed suffices : None

Default suffix : None

Examples: CFRQ:VALUE 1.23MHZ;INC 10KHZ
CFRQ:UP;XFER

CFRQ? Prepares message containing information on Carrier Frequency setting in the following format:

:CFRQ:VALUE <nr2>; INC <nr2>

Example: :CFRQ:VALUE 1000000000.0;INC 25000.0

RF LEVEL

RFLV Set RF output level (short form)
:VALUE Set RF output level

Data type : Decimal Numeric Program Data
Allowed suffices : Any one of: DBM, DBV, DBMV, DBUV, V, MV or UV
Default suffix : dBm unless changed by UNITS command

:INC Set RF level step (dB)

Data type : Decimal Numeric Program Data
Allowed suffices : DB only
Default suffix : DB

:UP Go UP one step
:DN Go DOWN one step
:RETN Return to original setting
:XFER Transfer current value to be the new setting
:ON Turn RF output ON
:OFF Turn RF output OFF

Data type : None
Allowed suffices : None
Default suffix : None

:TYPE Selects EMF or PD for voltage related units

Data type : Character Program Data (EMF or PD)
Allowed suffices : None
Default suffix : None

:UNITS Select default RF level units.

Data type : Character Program Data (DBM, DBV, DBMV, DBUV, V, MV or UV)
Allowed suffices : None
Default suffix : None

Examples: RFLV:VALUE -27.3DBM;ON
RFLV:TYPE PD;VALUE 1.23UV

RFLV (continued)

:OFFS [not used alone]
:VALUE Set Offset of current band

Data type : Decimal Numeric Program Data
Allowed suffices : DB only
Default suffix : DB

:ON Turn ON offset of current band
:OFF Turn OFF offset of current band
:ENABLE Enable Offsets
:DISABLE Disable Offsets
:SAVE Store Offsets in memory

Data type : None
Allowed suffices : None
Default suffix : None

Example: RFLV:OFFS:VALUE -0.2DB;ON;ENABLE

RFLV?

Prepares message containing information on RF Level setting in the following format:

:RFLV:UNITS <unit>;TYPE <type>;VALUE <nr2>;INC <nr2>;<status>

where: <unit> is character program data defining the default RF level units (DBM, DBV, DBMV, DBUV, V, MV or UV), <type> is character program data indicating EMF or PD and <status> is a program mnemonic indicating whether the RF output is ON or OFF.

Examples: :RFLV:UNITS DBM;VALUE -103.5;INC 2.0;ON
:RFLV:UNITS DBV;TYPE EMF;VALUE -83.2;INC 0.5;ON

RFLV:OFFS?

Prepares message containing information on RF Level offsets in the following format:

:CFRQ:VALUE <nr2>;:RFLV:OFFS:VALUE <nr2>;<status>;<activity>

where: <status> is a program mnemonic indicating whether the RF offset is ON or OFF and <activity> is a program mnemonic indicating whether the offset mode is enabled or disabled.

Example: :CFRQ:VALUE 500000000.0;;:RFLV:OFFS:VALUE -0.4;ON;ENABLE

RFLV (continued)

RFLV

:HYST [not used alone]
:ENABLE Enable Extended Hysteresis mode
:DISABLE Disable Extended Hysteresis mode

Data type : None
Allowed suffices : None
Default suffix : None

:RFLV:HYST? Responds with status as follows:

:RFLV:HYST:ENABLE
or **:RFLV:HYST:DISABLE**

RFLV

:LIMIT Set RF output level limit (short form)
:VALUE Set RF output level limit.

Data type : Decimal Numeric Program Data
Allowed suffices : Any one of DBM, DBV, DBMV, DBUV, V, MV or UV
Default suffix : dBm unless changed by UNITS command (see above).

:ENABLE Enable RF output level limit
:DISABLE Disable RF output level limit
:SAVE Save RF output level limit to memory

Data type : None
Allowed suffices : None
Default suffix : None

RFLV:LIMIT? Prepares message containing information on RF level setting in the following format:

:RFLV:UNITS <unit>;TYPE <type>;LIMIT:VALUE<nr2>;<status>

where: <unit> is character program data defining the default RF level units (DBM, DBV, DBMV, DBUV, V, MV or UV), <type> is character program data indicating EMF or PD and <status> is a program mnemonic indicating whether the RF level limit is enabled or disabled.

Examples: **:RFLV:UNITS DBM;LIMIT:VALUE -10.2;ENABLE**
:RFLV:UNITS V;TYPE PD;LIMIT:VALUE 0.224;DISABLE

MODULATION MODE

MODE Set modulation mode

Data type : Character Program Data (valid combinations of AM, AM1, AM2, FM, FM1, FM2, PM, PM1, PM2, WBFM or PULSE, see Table below)
Allowed suffices : None
Default suffix : None

Examples: MODE AM, FM
MODE FM1, FM2
MODE DIGITAL

VALID MODE COMBINATIONS TABLE

Digital Vector	Single	Composite	Dual	Dual Composite
Digital Vector	AM1	AM1,AM2	AM1,FM1	AM1,AM2,FM1,FM2
	FM1	FM1,FM2	AM1,PM1	AM1,AM2,PM1,PM2
	PM1	PM1,PM2	AM1,WBFM	AM1,AM2,WBFM
	WBFM		PULSE,FM1	PULSE,FM1,FM2
	PULSE		PULSE,PM1	PULSE,PM1,PM2
			PULSE,WBFM	

Note...

At any time the '1' may be omitted, for example FM is equivalent to FM1. Order is not important, for example AM,FM is equivalent to FM,AM.

For instruments without pulse modulation (Option 002) fitted, select Low Intermodulation mode by using character data type PULSE.

MODE? Prepares message containing information on Modulation Mode in the following format:

:MODE:<mode>

where: <mode> is character program data indicating the modulation mode settings.

Example: :MODE FM1, FM2
:MODE VECTOR

MODULATION CONTROL

MOD

:ON
:OFF

[not used alone]
Turn modulation globally ON
Turn modulation globally OFF

Examples: MOD:ON
MOD:OFF

MOD?

Prepares message containing information on Modulation Control in the following format:

:MOD:<status>

where: <status> is a program mnemonic indicating whether the Modulation is globally ON or OFF.

Example: :MOD:ON

DIGITAL MODULATION

MODE Set digital modulation mode (in addition to existing modulation mode commands)

Data type : Character Program Data
Allowed suffices : None
Default suffix : None

Example: MODE DIGITAL

MODE? Prepares message containing information on modulation mode in the following format:

:MODE <mode>

where: <mode> is character program data indicating the modulation mode setting.

Example: :MODE DIGITAL

DIGITAL [not used alone]
:MODOPT [not used alone]
:SBAND Select sideband control

Data type : Character Program Data (any one of: UPPER, LOWER, AUTO)
Allowed suffices : None
Default suffix : None

:IF Select IF control

Data type : Character Program Data (any one of: MHZ120, MHZ132, MHZ160, MHZ176, AUTO)
Allowed suffices : None
Default suffix : None

:MODPOL Select modulation polarity control

Data type : Character Program Data (either NORMAL or INVERSE)
Allowed suffices : None
Default suffix : None

:ENVELOPE Select external envelope input control

Data type : Character Program Data (either DISABLED or ENABLED)
Allowed suffices : None
Default suffix : None

:CONFIG [not used alone]
:MIXER Select mixer control

Data type : Character Program Data (either INTERNAL or EXTERNAL)
Allowed suffices : None
Default suffix : None

DIGITAL (continued)

:CONFIG

:IQ Select IQ output enable control
Data type : Character Program Data (either DISABLED or ENABLED)
Allowed suffices : None
Default suffix : None

:PULSE Select pulse input control
Data type : Character Program Data (either ENABLED or DISABLED)
Allowed suffices : None
Default suffix : None

:FADING

[not used alone]
:CTRL Select fading control
Data type : Character Program Data (any one of: DISABLED, RAYLEIGH, RICIAN)
Allowed suffices : None
Default suffix : None

:SPEED Set doppler speed
Data type : Decimal Numeric Program Data
Allowed suffices : Any one of GHz, MHz, kHz, Hz
Default suffix : Hz

:DIR_DOPP Set direct doppler path
Data type : Decimal Numeric Program Data
Allowed suffices : Any one of: GHz, MHz, kHz, Hz
Default suffix : Hz

:RATIO Set path ratio (direct to scattered) - Rayleigh Fading only
Data type : Decimal Numeric Program Data
Allowed suffices : DB only
Default suffix : DB

:ERROR

[not used alone]
:ENABLE Enable IQ modulator errors
:DISABLE Disable IQ modulator errors
Data type : None
Allowed suffices : None
Default suffix : None

:SKEW

:VALUE Set IQ skew error (short form)
Set IQ skew error
Data type : Decimal Numeric Program Data
Allowed suffices : DEG
Default suffix : DEG

DIGITAL (continued)

SKEW

:ON Turn on IQ skew error
:OFF Turn off IQ skew error

Data type : None
Allowed suffices : None
Default suffix : None

:GAIN Set IQ gain imbalance error (short form)
:VALUE Set IQ gain imbalance error

Data type : Decimal Numeric Program Data
Allowed suffices : DB only
Default suffix : DB

:ON Turn on IQ gain imbalance error
:OFF Turn off IQ gain imbalance error

Data type : None
Allowed suffices : None
Default suffix : None

:LEAK Set carrier leakage error (short form)
:VALUE Set carrier leakage error

Data type : Decimal Numeric Program Data
Allowed suffices : PCT
Default suffix : PCT

:ON Turn on IQ carrier leakage error
:OFF Turn off IQ carrier leakage error

Data type : None
Allowed suffices : None
Default suffix : None

:SYSTEM [not used alone]
:FORMAT Select modulation type

Data type : Character Program Data (any one of: QAM4, QAM16, QAM64, QAM256, BPSK, QPSK, PSK8, O_BPSK, O_QPSK, O_PSK8, D_BPSK, D_QPSK, D_PSK8, FSK2, FSK4, GMSK, TOQPSK, T_TONES)
Allowed suffices : None
Default suffix : None

:FILTER Select filter type

Data type : Character Program Data (any one of: R_R_COS, R_COS, GAUSS)
Allowed suffices : None
Default suffix : None

DIGITAL (continued)

:SYSTEM

:SYM_RATE Set symbol rate

Data type : Decimal Numeric Program Data
Allowed suffices : Any one of: GHz, MHz, kHz, Hz
Default suffix : Hz

:ALPHA Set filter alpha

Data type : Decimal Numeric Program Data
Allowed suffices : None
Default suffix : None

:THREE_DB Set filter 3 dB

Data type : Decimal Numeric Program Data
Allowed suffices : Any one of: GHz, MHz, kHz, Hz
Default suffix : Hz

:DEVN Set FSK deviation

Data type : Decimal Numeric Program Data
Allowed suffices : Any one of: GHz, MHz, kHz, Hz
Default suffix : Hz

:SELECT Select an IQ system

Data type : Character Program Data (any one of: NADC, PDC, TETRA, Q_APCO25, ERMES, POC512, POC1200, POC2400, POC4800, CITY512, CITY1200, CITY2400, CITY4800, MOBITEX, MC9, MD24N, MD36N, MD48N, MD80N, MD96N, MD160N, MD24W, MD36W, MD48W, MD80W, MD96W, MD100W, MD120W, MD192W, TFTS, DSRR4, DSRR16, CDPD, GSM, INMAR_M, VDR, USER1, USER2, USER3, USER4, USER5)
Allowed suffices : None
Default suffix : None

:STO Store setup to user defined system

Data type : Character Program Data (any one of: USER1, USER2, USER3, USER4, USER5)
Allowed suffices : None
Default suffix : None

:EXT_SER [not used alone]

:DATAPOL Select external serial data and specify the data polarity

Data type : Character Program Data (either NORMAL or INVERSE)
Allowed suffices : None
Default suffix : None

:BITSTAT Select external serial data and specify the bit clock status

Data type : Character Program Data (either INTERNAL or EXTERNAL)
Allowed suffices : None
Default suffix : None

DIGITAL (continued)

- :EXT_SER**
:BITPOL Select external serial data and specify the bit clock polarity
Data type : Character Program Data (either POS_EDGE or NEG_EDGE)
Allowed suffices : None
Default suffix : None
- :SYMSTAT** Select external serial data and specify the symbol clock status
Data type : Character Program Data (either INTERNAL or EXTERNAL)
Allowed suffices : None
Default suffix : None
- :SYMPOL** Select external serial data and specify the symbol clock polarity
Data type : Character Program Data (either POS_EDGE or NEG_EDGE)
Allowed suffices : None
Default suffix : None
- :EXT_PAR** [not used alone]
:DATAPOL Select external parallel data and specify the data polarity
Data type : Character Program Data (either NORMAL or INVERSE)
Allowed suffices : None
Default suffix : None
- :EXT_PAR**
:SYMSTAT Select external parallel data and specify the symbol clock status
Data type : Character Program Data (either INTERNAL or EXTERNAL)
Allowed suffices : None
Default suffix : None
- :SYMPOL** Select external parallel data and specify the symbol clock polarity
Data type : Character Program Data (either POS_EDGE or NEG_EDGE)
Allowed suffices : None
Default suffix : None
- :INT_OS** [not used alone]
:DATAPOL Select internal "all-zeros" data and specify the data polarity
Data type : Character Program Data (either NORMAL or INVERSE)
Allowed suffices : None
Default suffix : None
- :CLOCK** Select internal "all-zeros" and specify the clock source
Data type : Character Program Data (any one of: INT_SYM, EXT_SYM, EXT_BIT)
Allowed suffices : None
Default suffix : None

DIGITAL (continued)

- :INT_0S**
:CLOCKPOL Select internal "all-zeros" and specify the clock polarity
Data type : Character Program Data (either POS_EDGE or NEG_EDGE)
Allowed suffices : None
Default suffix : None
- :INT_1S** [not used alone]
:DATAPOL Select internal "all-ones" data and specify the data polarity
Data type : Character Program Data (either NORMAL or INVERSE)
Allowed suffices : None
Default suffix : None
- :INT_1S**
:CLOCK Select internal "all-ones" and specify the clock source
Data type : Character Program Data (any one of: INT_SYM, EXT_SYM, EXT_BIT)
Allowed suffices : None
Default suffix : None
- :CLOCKPOL** Select internal "all-ones" and specify the clock polarity
Data type : Character Program Data (either POS_EDGE or NEG_EDGE)
Allowed suffices : None
Default suffix : None
- :PRBS**
:VALUE Select internal "prbs" data and specify the "n" value
Select internal "prbs" data and specify the "n" value
Data type : Decimal Numeric Program Data
Allowed suffices : None
Default suffix : None
- :DATAPOL** Select internal "prbs" data and specify the data polarity
Data type : Character Program Data (either NORMAL or INVERSE)
Allowed suffices : None
Default suffix : None
- :CLOCK** Select internal "prbs" data and specify the clock source
Data type : Character Program Data (any one of: INT_SYM, EXT_SYM, EXT_BIT)
Allowed suffices : None
Default suffix : None
- :CLOCKPOL** Select internal "prbs" data and specify the clock polarity
Data type : Character Program Data (either POS_EDGE or NEG_EDGE)
Allowed suffices : None
Default suffix : None

DIGITAL (continued)

:T_TONES [not used alone]

:FREQ Specify the test tone frequency setting

Data type : Decimal Numeric Program Data
Allowed suffices : Any one of: GHZ, MHZ, KHZ, HZ
Default suffix : Hz

:I_AMP Specify the test tone I amplitude setting

Data type : Decimal Numeric Program Data
Allowed suffices : V only
Default suffix : V

:I_DC Specify the test tone I DC-offset setting

Data type : Decimal Numeric Program Data
Allowed suffices : V only
Default suffix : V

:Q_AMP Specify the test tone Q amplitude setting

Data type : Decimal Numeric Program Data
Allowed suffices : V only
Default suffix : V

:Q_DC Specify the test tone Q DC-offset setting

Data type : Decimal Numeric Program Data
Allowed suffices : V only
Default suffix : V

:ANGLE Specify the test tone IQ angle setting

Data type : Decimal Numeric Program Data
Allowed suffices : DEG
Default suffix : DEG

:CAL Execute IQ Autocal

Data type : None
Allowed suffices : None
Default suffix : None

:MODOPT? Prepares message containing information on DIGITAL modulation control setting in the following format:

:DIGITAL:MODOPT:SBAND<status>;IF<status>;MODPOL<status>;ENVELOPE<status>

where: <status> is character program data for the specified mnemonic.

Example: **:DIGITAL:MODOPT:SBAND AUTO;IF MHZ120;MODPOL INVERSE;ENVELOPE DISABLED**

DIGITAL (continued)

:CONFIG?

Prepares message containing information on DIGITAL modulation setting in the following format:

:DIGITAL:CONFIG:MIXER<status>;IQ<status>;PULSE<status>

where: <status> is character program data for the specified mnemonic.

Example: **:DIGITAL:CONFIG:MIXER EXTERNAL;IQ DISABLED;PULSE ENABLED**

:FADING?

Prepares message containing information on DIGITAL modulation fading setting in the following format:

:DIGITAL:FADING:CTRL<status>;SPEED <nr2>;DIR_DOPP <nr2>;RATIO <nr2>

where: <status> is character program data for the specified mnemonic.

Example: **:DIGITAL:FADING:CTRL RAYLEIGH;SPEED 52;DIR_DOPP 0;RATIO 12**

:ERROR?

Prepares message containing information on the IQ error control in the following format:

:DIGITAL:ERROR:<status>

where: <status> is a program mnemonic indicating whether the IQ errors are globally ENABLE or DISABLE.

Example: **:DIGITAL:ERROR:ENABLE**

:SKEW?

Prepares message containing information on the IQ skew error setting in the following format:

:DIGITAL:SKEW:VALUE <nr2>;<status>

where: <status> is a program mnemonic indicating whether the IQ skew error is ON or OFF.

Example: **:DIGITAL:SKEW:VALUE 10.1; OFF**

:GAIN?

Prepares message containing information on the IQ gain imbalance error setting in the following format:

:DIGITAL:GAIN:VALUE <nr2>; <status>

where: <status> is a program mnemonic indicating whether the IQ gain imbalance error is ON or OFF.

Example: **:DIGITAL:GAIN:VALUE -27; ON**

DIGITAL (continued)

:LEAK?

Prepares message containing information on the carrier leakage error setting in the following format:

`:DIGITAL:LEAK:VALUE <nr2>; <status>`

where: <status> is a program mnemonic indicating whether the carrier leakage error is ON or OFF.

Example: `:DIGITAL:LEAK:VALUE 0.0; OFF`

:SYSTEM?

Prepares message containing information on the modulation system setup in one of the following formats:

`AL:SYSTEM:FORMAT<status>;FILTER<status>;
SYM_RATE <nr2>;ALPHA <nr2>`

`:DIGITAL:SYSTEM:FORMAT<status>;FILTER<status>;
SYM_RATE <nr2>;THREE_DB<status>`

where: <status> is character program data for the specified mnemonic.

Examples: `:DIGITAL:SYSTEM:FORMAT QAM256;FILTER R_R_COS;
SYM_RATE 24300.0; ALPHA 0.45`

`:DIGITAL:SYSTEM:FORMAT BPSK; FILTER GAUSS;
SYM_RATE 6000.0;THREE_DB 1200`

DIGITAL?

Prepares message containing information on the data and timing selected in one of the following formats:

`:DIGITAL:EXT_SER:DATAPOL<status>;BITSTAT<status>;
BITPOL<status>; SYMSTAT<status>;SYMPOL<status>`

`:DIGITAL:EXT_PAR:DATAPOL<status>;SYMSTAT<status>;
SYMPOL<status>`

`:DIGITAL:INT_0S:DATAPOL<status>;CLOCK<status>;
CLOCKPOL<status>`

`:DIGITAL:INT_1S:DATAPOL<status>;CLOCK<status>;
CLOCKPOL<status>`

where: <status> is character program data for the specified mnemonic.

Examples: `:DIGITAL:EXT_PAR:DATAPOL INVERSE;SYMSTAT
EXTERNAL;SYMPOL NEG_EDGE`

`:DIGITAL:PRBS:VALUE 6;DATAPOL NORMAL;CLOCK INT_SYM;
CLOCKPOL POS_EDGE`

DIGITAL:T_TONES:FREQ? Prepares message containing information on the test tone frequency setting in the following format:

DIGITAL:T_TONES:FREQ <nr2>

Example: :DIGITAL:T_TONES:FREQ 1000

:T_TONES:I_AMP? Prepares message containing information on the test tone I amplitude setting in the following format:

:DIGITAL:T_TONES:I_AMP <nr2>

Example: :DIGITAL:T_TONES:I_AMP 2.763

:T_TONES:I_DC? Prepares message containing information on the test tone I DC-offset setting in the following format:

:DIGITAL:T_TONES:I_DC <nr2>

Example: :DIGITAL:T_TONES:I_DC -0.423

:T_TONES:Q_AMP? Prepares message containing information on the test tone Q amplitude setting in the following format:

:DIGITAL:T_TONES:Q_AMP <nr2>

Example: :DIGITAL:T_TONES:Q_AMP 0.500

:T_TONES:Q_DC? Prepares message containing information on the test tone Q DC-offset setting in the following format:

:DIGITAL:T_TONES:Q_DC <nr2>

Example: :DIGITAL:T_TONES:Q_DC 2.000

:T_TONES:ANGLE? Prepares message containing information on the test tone IQ angle setting in the following format:

:DIGITAL:T_TONES:ANGLE<nr2>

Example: :DIGITAL:T_TONES:ANGLE 263.7

VECTOR MODULATION

MODE Set vector modulation mode (in addition to existing modulation mode commands).

Data type : Character Program Data
Allowed suffices : None
Default suffix : None

Example: MODE VECTOR

MODE? Prepares message containing information on modulation mode in the following format:

:MODE <mode>

where: <mode> is character program data indicating the modulation mode setting.

Example: MODE VECTOR

:MODPOL Select modulation polarity control

Data type : Character Program Data (either NORMAL or INVERSE)
Allowed suffices : None
Default suffix : None

:ENVELOPE Select external envelope input control

Data type : Character Program Data (either DISABLED or ENABLED)
Allowed suffices : None
Default suffix : None

:CONFIG [not used alone]

:MIXER Select mixer control

Data type : Character Program Data (either INTERNAL or EXTERNAL)
Allowed suffices : None
Default suffix : None

:IQ Select IQ input impedance

Data type : Character Program Data (either OHMS50 or OHMS300)
Allowed suffices : None
Default suffix : None

:PULSE Select pulse input control

Data type : Character Program Data (either ENABLED or DISABLED)
Allowed suffices : None
Default suffix : None

VECTOR (continued)

- :FADING** [not used alone]
:CTRL Select fading type
- Data type : Character Program Data (any one of: DISABLED, RAYLEIGH, RICIAN)
Allowed suffices : None
Default suffix : None
- :SPEED** Set doppler speed
- Data type : Decimal Numeric Program Data
Allowed suffices : Any one of GHz, MHz, kHz, Hz
Default suffix : Hz
- :DIR_DOPP** Set direct doppler path
- Data type : Decimal Numeric Program Data
Allowed suffices : Any one of: GHz, MHz, kHz, Hz
Default suffix : Hz
- :RATIO** Set path ratio (direct to scattered) - Rayleigh Fading only
- Data type : Decimal Numeric Program Data
Allowed suffices : DB only
Default suffix : DB
- :MODOPT?** Prepares message containing information on VECTOR modulation control setting in the following format:
- :VECTOR:MODOPT:SBAND<status>;IF<status>;MODPOL<status>;ENVELOPE<status>**
- where: <status> is character program data for the specified mnemonic.
- Example:** **:VECTOR:MODOPT:SBAND LOWER;IF MHZ176;MODPOL NORMAL;ENVELOPE ENABLED**
- :CONFIG?** Prepares message containing information on VECTOR modulation setting in the following format:
- :VECTOR:CONFIG:MIXER<status>;IQ<status>;PULSE<status>**
- where: <status> is character program data for the specified mnemonic.
- Example:** **:VECTOR:CONFIG:MIXER EXTERNAL;IQ OHMS50;PULSE DISABLED**
- :FADING?** Prepares message containing information on VECTOR modulation fading settings in the following format:
- :VECTOR:FADING:CTRL<status>;SPEED<nr2>;DIR_DOPP <nr2>; RATIO <nr2>**
- where: <status> is character program data for the specified mnemonic.
- Example:** **:VECTOR:FADING:RICIAN;SPEED 100;DIR_DOPP 200;RATIO 25**

VECTOR (continued)

:CAL

Execute IQ Autocal

Data type : None
Allowed suffices : None
Default suffix : None

FREQUENCY MODULATION

FM or FM1 or FM2

:DEVN

:INC

Set FM deviation (short form)

Set FM deviation

Set FM step size

Data type : Decimal Numeric Program Data

Allowed suffices : Any one of: GHZ, MHZ, KHZ or HZ

Default suffix : HZ

:<src>

Select modulation source where <src> is any one of: INTF1, INTF2, INTF3, INTF4, INTF5, INTF6, EXT1DC, EXT1AC, EXT1ALC, EXT2DC, EXT2AC or EXT2ALC

:ON

Turn FM ON (locally)

:OFF

Turn FM OFF (locally)

:UP

Go UP one step

:DN

Go DOWN one step

:RETN

Return to original setting

:XFER

Transfer current value to be the new setting

DCFMNL

Perform DC FM/WBFM null operation

Data type : None

Allowed suffices : None

Default suffix : None

Examples:

FM:DEVN 25KHZ;INTF4;ON

FM1:DEVN 15KHZ;INC 1KHZ;EXT1DC

DCFMNL

FM? or FM1? or FM2?

Prepares message containing information on FM setting in one of the following formats:

:FM:DEVN <nr2>;<src>;<status>;INC <nr2>

:FM1:DEVN <nr2>;<src>;<status>;INC <nr2>

:FM2:DEVN <nr2>;<src>;<status>;INC <nr2>

where: <src> is a program mnemonic representing the source of the modulation signal and <status> is a program mnemonic indicating whether the modulation is locally ON or OFF

Example: :FM1:DEVN 25000.0;INTF1;ON;INC 1000.0

PHASE MODULATION

PM or PM1 or PM2 Set Phase deviation (short form)
:DEVN Set Phase deviation
:INC Set Phase Modulation step size

Data type : Decimal Numeric Program Data
Allowed suffices : RAD or RADS
Default suffix : RAD

:<src> Select modulation source where <src> is any one of: INTF1, INTF2, INTF3, INTF4, INTF5, INTF6, EXT1DC, EXT1AC, EXT1ALC, EXT2DC, EXT2AC or EXT2ALC

:ON Turn PM ON (local)
:OFF Turn PM OFF (local)
:UP Go UP one step
:DN Go DOWN one step
:RETN Return to original setting
:XFER Transfer current value to be the new setting

Data type : None
Allowed suffices : None
Default suffix : None

Examples: PM:DEVN 2.5RAD;INTF4;ON
PM1:DEVN 1.5RAD;INC 0.1RAD;EXT1AC

PM? or PM1? or PM2? Prepares message containing information on Phase Modulation setting in one of the following formats:

:PM:DEVN <nr2>;<src>;<status>;INC <nr2>
:PM1:DEVN <nr2>;<src>;<status>;INC <nr2>
:PM2:DEVN <nr2>;<src>;<status>;INC <nr2>

where <src> is a program mnemonic representing the source of the modulation signal and <status> is a program mnemonic indicating whether the modulation is locally ON or OFF

Example: :PM2:DEVN 2.30;INTF4;OFF;INC 0.05

AMPLITUDE MODULATION

AM or AM1 or AM2 Set AM Depth (short form)
:DEPTH Set AM Depth
:INC Set AM step size

Data type : Decimal Numeric Program Data
Allowed suffices : PCT
Default suffix : PCT

:<src> Select modulation source where <src> is any one of: INTF1, INTF2, INTF3, INTF4, INTF5, INTF6, EXT1DC, EXT1AC, EXT1ALC, EXT2DC, EXT2AC or EXT2ALC

:ON Turn AM ON (local)
:OFF Turn AM OFF (local)
:UP Go UP one step
:DN Go DOWN one step
:RETN Return to original setting
:XFER Transfer current value to be the new setting

Data type : None
Allowed suffices : None
Default suffix : None

Examples: AM:DEPTH 30PCT;INTF4;ON
AM1:DEPTH 40PCT;EXT1DC;ON

AM? or AM1? or AM2? Prepares message containing information on Amplitude Modulation setting in one of the following formats:

:AM:DEPTH <nr2>;<src>;<status>;INC <nr2>
:AM1:DEPTH <nr2>;<src>;<status>;INC <nr2>
:AM2:DEPTH <nr2>;<src>;<status>;INC <nr2>

where <src> is a program mnemonic representing the source of the modulation signal and <status> is a program mnemonic indicating whether the modulation is locally ON or OFF

Example: :AM1:DEPTH 56.6;INTF3;ON;INC 5.0

WIDEBAND FM

WBFM Set WBFM deviation (short form)
:DEVN Set WBFM deviation

Data type : Decimal Numeric Program Data
Allowed suffices : Any one of: GHZ, MHZ, KHZ or HZ
Default suffix : HZ

:ON Turn WBFM ON (local)
:OFF Turn WBFM OFF (local)
:AC Select AC coupling
:DC Select DC coupling

Data type : None
Allowed suffices : None
Default suffix : None

DCFMNL Perform DC FM/WBFM null operation

Examples: WBFM:DEVN 10MHZ;ON;AC
WBFM:DEVN 13MHZ;ON;DC;:DCFMNL

WBFM? Prepares message containing information on Wideband Frequency Modulation setting in the following format:

:WBFM:DEVN <nr2>;<coupling>;<status>

where <coupling> is a program mnemonic indicating AC or DC coupling of the modulation signal and <status> is a program mnemonic indicating whether the modulation is locally ON or OFF

Example: :WBFM:DEVN 500000.0;AC;ON

PULSE MODULATION

PULSE [not used alone]
:ON Turn Pulse modulation ON
:OFF Turn Pulse modulation OFF and select Low Intermodulation
:CAL:ENABLE Enable CW Burst Suppression mode
:DISABLE Disable CW Burst Suppression mode

Data type : None
Allowed suffices : None
Default suffix : None

Examples: PULSE:ON
PULSE:OFF
PULSE:CAL:DISABLE

PULSE? Prepares message containing information on Pulse Modulation setting in the following format:

:PULSE:<status>

where: <status> is a program mnemonic indicating whether the modulation is ON or OFF

Examples: :PULSE:ON
:PULSE:OFF

PULSE:CAL? Prepares message containing information on CW Burst Suppression mode in the following format:

:PULSE:CAL:<status>

where: <status> is a program mnemonic indicating whether the CW burst suppression mode is ENABLED or DISABLED

Example: :PULSE:CAL:ENABLE

MODULATION FREQUENCY

INTF1 or INTF2 or INTF3 or INTF4 or INTF5 or INTF6 Set modulation oscillator frequency (short form)

:FREQ Set modulation oscillator frequency
:INC Set modulation oscillator frequency step size

Data type : Decimal Numeric Program Data
Allowed suffices : Any one of: GHZ, MHZ, KHZ or HZ
Default suffix : HZ

:SIN Select sinusoidal waveform
:TRI Select triangle waveform
:SQU Select square waveform
:UP Go UP one step
:DN Go DOWN one step
:RETN Return to original setting
:XFER Transfer current value to be the new setting

Data type : None
Allowed suffices : None
Default suffix : None

:PHASE Adjust phase of modulation oscillator

Data type : Decimal Numeric Program Data
Allowed suffices : DEG
Default suffix : DEG

:CTC1 Select tone number (0 to 15) from Continuous Tone Group 1
:CTC2 Select tone number (0 to 15) from Continuous Tone Group 2
:USER Select tone number (0 to 15) from Continuous Tone USER group
:TEMP Select tone number (0 to 15) from Continuous Tone TEMP group

Data type : Decimal Numeric Program Data
Allowed suffices : None
Default suffix : None

Examples: INTF1:FREQ 1.5KHZ;SIN
INTF1:CTC1 3

INTF1, etc. (continued)

**INTF1? or INTF2? or INTF3? or
INTF4? or INTF5? or INTF6?** Prepares message containing information on modulation
oscillator setting in one of the following formats:

```
:INTF1:FREQ <nr2>;INC <nr2>;<waveform>  
:INTF6:<standard> <nr1>
```

where: <waveform> is a program mnemonic (SIN or TRI)
indicating the waveform shape and <standard> is a
program mnemonic (CTC1, CTC2, USER or TEMP)
indicating the continuous tone signalling standard
selected.

Examples: :INTF2:FREQ 440.0;INC 100.0;SIN
 :INTF3:CTC1 5

CTCSS TONES EDIT

CTONES [not used alone]
:EDIT [not used alone]
:TNUM Select tone number 0-15

Data type : Decimal Numeric Program Data
Allowed suffices : None
Default suffix : None

:TFRQ Set tone frequency

Data type : Decimal Numeric Program Data
Allowed suffices : Any one of: GHZ, MHZ, KHZ or HZ
Default suffix : HZ

:LOAD Copy Standard to TEMP for editing

Data type : Character Program Data (any one of: CTC1, CTC2 or USER)
Allowed suffices : None
Default suffix : None

:SAVE Save TEMP to USER after editing for non-volatile storage (if required)

Data type : None
Allowed suffices : None
Default suffix : None

CTONES? [not used alone]

CTONES:EDIT? Prepares message containing information on the current tone number being edited and its frequency in the following format:

`:CTONES:EDIT:TNUM <nr1>;TFRQ <nr2>`

Example: `:CTONES:EDIT:TNUM 5;TFRQ 202.8`

SEQUENTIAL TONES

SEQT	[not used alone]
:SEQ	Set Tone sequence
	Data type : String Program Data consisting of up to 16 characters from 0 to 9 and A to F between string delimiters (eg. "123C5" or '123C5'). For DTMF E and F are not allowed and are replaced by * and #.
	Allowed suffices : None
	Default suffix : None
:DUR	Set Duration Mask
	Data type : String Program Data consisting of up to 15 characters "-" or "E" between string delimiters (eg. "---E-" or '---E-')
	Allowed suffices : None
	Default suffix : None
:SEND	Send Sequence <i>n</i> times where <i>n</i> has the value 1 to 9 indicating the number of tone sequences to be sent.
	Data type : Decimal Numeric Program Data
	Allowed suffices : None
	Default suffix : None
:STOP	Stop sending sequence.
	Data type : None
	Allowed suffices : None
	Default suffix : None
:MODE	[not used alone]
:STD	Select Tones standard
	Data type : Character Program Data (any one of: CCIR, EURO, DZVEI, ZVEI1, ZVEI2, EEA, EIA, NATEL, TEMP, USER1, USER2 or DTMF).
	Allowed suffices : None
	Default suffix : None
:MOD	Select Modulation Channel
	Data type : Character Program Data (any one of: AM1, AM2, FM1, FM2, PM1, PM2, TOTAL_AM, TOTAL_FM, TOTAL_PM or NO_TONES)
	Allowed suffices : None
	Default suffix : None

SEQT (continued)

:PARAM [not used alone]
:EXTD Set the duration of the Extended tone.
:SDLY Set Starting Delay

Data type : Decimal Numeric Program Data
Allowed suffices : MS
Default suffix : MS

:SHFT Set Frequency Shift (up to $\pm 10.0\%$)

Data type : Decimal Numeric Program Data
Allowed suffices : PCT
Default suffix : PCT

:RPTT Select Repeat Tone

Data type : String Program Data (any one of 0 to 9 or A to F between strings delimiters (eg. "E" or 'E')).
Allowed suffices : None
Default suffix : None

:TDUR Set DTMF Tone duration
:TGAP Set DTMF inter-element gap

Data type : Decimal Numeric Program Data
Allowed suffices : MS
Default suffix : MS

:EDIT [not used alone]
:TNUM Select Number of Tone to Edit

Data type : Decimal Numeric Program Data
Allowed suffices : None
Default suffix : None

:TFRQ Set Tone Frequency of tone selected by TNUM

Data type : Decimal Numeric Program Data
Allowed suffices : Any one of: GHZ, MHZ, KHZ or HZ
Default suffix : HZ

:TDUR Set Normal Tone Duration
:TGAP Set Inter-element Gap

Data type : Decimal Numeric Program Data
Allowed suffices : MS
Default suffix : MS

:LOAD Load a Standard to TEMP for editing

Data type : Character Program Data (any one of: CCIR, EURO, DZVEI, ZVEI1, ZVEI2, EEA, EIA, NATEL, USER1 or USER2)
Allowed suffices : None
Default suffix : None

SEQT:EDIT (continued)

:SAVE Copy TEMP to USER1 or USER2

Data type : Character Program Data (either USER1 or USER2)
Allowed suffices : None
Default suffix : None

Examples: SEQT:SEQ "12245B7";DUR "----E--"
SEQT:MODE STD CCIR;MOD TOTAL_FM
SEQT:PARAM:EXTD 200MS;SHFT 0.5PCT
SEQT:EDIT:TNUM 3;TFRQ 1342.7HZ;SAVE USER1

SEQT?

Prepares message containing information on the signalling sequence and duration settings in the following format:

:SEQT:SEQ <toneseq>;DUR <durseq>

where: <toneseq> is string program data defining the tone sequence and <durseq> is string program data defining the duration sequence.

Examples: :SEQT:SEQ "12245B7";DUR "----E--"
:SEQT:SEQ "12345*#9" (DTMF ONLY)

SEQT:MODE?

Prepares message containing information on the signalling standard and the modulation channel selected in the following format:

:SEQT:MODE:STD <standard>;MOD <modchannel>

where: <standard> is a program mnemonic defining the tone standard and <modchannel> is character program data defining the modulation channel allocated to tone signalling.

Example: :SEQT:MODE:STD ZVEI;MOD TOTAL_FM

SEQT:PARAM?

Prepares message containing information on signalling parameter settings in the following format:

:SEQT:PARAM:EXTD <nr1>;SHFT <nr2>;RPTT <rpt>;SDLY <nr1>

where: <rpt> is string program data defining the tone number used to represent the repeat tone.

Examples: :SEQT:PARAM:EXTD 200;SHFT -1.6;RPTT "E";SDLY 300
:SEQT:PARAM:SDLY 30;TDUR 100;TGAP 75 (DTMF ONLY)

SEQT:EDIT?

Prepares message containing information on signalling editing in the following format:

:SEQT:EDIT:TNUM <nr1>;TFREQ <nr2>;TDUR <nr1>;TGAP <nr1>

Example: :SEQT:EDIT:TNUM 3;TFREQ 1342.7;TDUR 40;TGAP 0

LF CONTROL

LF [not used alone]
:ON Turn LF output ON
:OFF Turn LF output OFF
:GEN Select LF Generator

Data type : None
Allowed suffices : None
Default suffix : None

:MON Select source monitor mode

Data type : Character Program Data (any one of: AM1S, AM2S, AMD, ANG1S, ANG2S, ANGD or OFF, where AM represents Amplitude Modulation, ANG represents Angular Modulation, the suffix 'S' indicates Source and 'D' indicates Drive)
Allowed suffices : None
Default suffix : None

Examples: LF:MON FM;ON
LF:MON ANGD
LF:GEN

LF? Prepares message containing information on the LF operation in one of the following formats depending on which LF mode is currently in use:

:LF:GEN;<status>
:LF:MON <source>;<status>

where: <source> is character program data representing the source being monitored and <status> is a program mnemonic indicating whether the output is ON or OFF.

Examples: :LF:GEN;ON
:LF:MON AM1S;OFF

LF GENERATOR FREQUENCY

LFGF Set LF Generator frequency (short form)
:VALUE Set LF Generator frequency
:INC Set LF Generator frequency step

Data type : Decimal Numeric Program Data
Allowed suffices : Any one of: GHZ, MHZ, KHZ or HZ
Default suffix : HZ

:UP Go UP one step
:DN Go DOWN one step
:RETN Return to original setting
:XFER Transfer current value to be the new setting
:SIN Select sinusoidal waveform
:TRI Select triangle waveform
:SQU Select square waveform

Data type : None
Allowed suffices : None
Default suffix : None

Example: LFGF:VALUE 25KHZ;INC 500HZ

LFGF? Prepares message containing information on LF Generator Frequency setting in the following format:

:LFGF:VALUE <nr2>;INC <nr2>

Example: :LFGF:VALUE 25067.8;INC 500.0

LF GENERATOR LEVEL

LFGL Set LF Generator level (short form)
:VALUE Set LF Generator level

Data type : Decimal Numeric Program Data
Allowed suffices : V, MV, UV, DBMV
Default suffix : V

:INC Set LF Generator level step

Data type : Decimal Numeric Program Data
Allowed suffices : DB
Default suffix : DB

:UP Go UP one step

:DN Go DOWN one step

:RETN Return to original setting

:XFER Transfer current value to be the new setting

Data type : None
Allowed suffices : None
Default suffix : None

:UNITS Select default LF level units

Data type : Character Program Data (DBM, DBV, DBMV, V, MV, or UV)
Allowed suffices : None
Default suffix : None

Examples: LFGL:VALUE 75.6MV;INC 20DB
LFGL:UP

LFGL? Prepares the message containing information on LF Generator Level setting in the following format:

:LFGL:UNITS<unit>;VALUE<nr2>;INC<nr2>

where: <unit> is character programmed data defining the default LF level units (DBM, DBV, DBMV, V, MV or UV).

Example: :LFGL:UNITS MV;VALUE 125.8;INC 1.0

MEMORY - STORE

STO [not used alone]
:FULL Full Store 0-49
:PART Partial Store 0-49
:CFRQ Carrier Freq Store 0-99
:SEQT Sequential Tones Store 0-19
:SWEEP Sweep Store 0-19

Data type : Decimal Numeric Program Data
Allowed suffices : None
Default suffix : None

Examples: :STO:FULL 17
:STO:CFRQ 83

MEMORY - RECALL

RCL [not used alone]
:FULL Recall Full 0-49
:FXCF Recall Full 0-49 (without carrier frequency)
:PART Recall Partial 0-49
:PXCF Recall Partial 0-49 (without carrier frequency)
:CFRQ Recall Carrier Freq 0-99
:SEQT Recall Sequential Tones Sequence 0-19
:SWEEP Recall Sweep 0-19

Data type : Decimal Numeric Program Data
Allowed suffices : None
Default suffix : None

Examples: :RCL:FULL 15
:RCL:CFRQ 75

MEMORY - ERASE

ERASE [not used alone]
:FULL Erase all Full Stores
:PART Erase all Partial Stores
:CFRQ Erase all Carrier Freq Stores
:SEQT Erase all Sequential Tones Stores
:SWEEP Erase all Sweep Stores
:ALL Erase all Stores

Data type : None
Allowed suffices : None
Default suffix : None

Examples: :ERASE:FULL 12
:ERASE:ALL

SWEEP OPERATION

IMODE

Select Instrument Mode

Data type : Character Program Data (either NORMAL for signal generator operation or SWEEPER for swept operation)
Allowed suffices : None
Default suffix : None

Example: IMODE SWEEPER

SWEEP

[not used alone]

:MKRON
:MKROFF

Enable Sweep Markers
Disable sweep Markers

Data type : None
Allowed suffices : None
Default suffix : None

Examples: SWEEP:CFRQ:START 75MHZ;STOP 150MHZ;STEP 100;TIME 10MS
SWEEP:RFLV:START -56DBM;STOP -12DBM;STEP 440;TIME 25MS
SWEEP:CFRQ:MKRNUM 1;VALUE 83MHZ;MKRON

:CFRQ

[not used alone]

:<cmd>

Select Carrier Frequency sweep parameter entry where <cmd> is replaced by one of the commands (START, STOP, STEP, TIME, MKRNUM, MKRON, MKROFF or VALUE)

:RFLV

[not used alone]

:<cmd>

Select RF Level sweep parameter entry where <cmd> is replaced by one of the commands (START, STOP, STEP, TIME, MKRNUM, MKRON, MKROFF or VALUE)

:LFGF

[not used alone]

:<cmd>

Select LF Generator Frequency sweep parameter entry where <cmd> is replaced by one of the commands (START, STOP, STEP, TIME, MKRNUM, MKRON, MKROFF or VALUE)

:LFGL

[not used alone]

:<cmd>

Select LF Generator Level sweep parameter entry where <cmd> is replaced by one of the commands (START, STOP, STEP, TIME, MKRNUM, MKRON, MKROFF or VALUE)

:INTF

[not used alone]

:<cmd>

Select Internal Modulation Oscillator Frequency sweep parameter entry where <cmd> is replaced by one of the commands (START, STOP, STEP, TIME, MKRNUM, MKRON, MKROFF or VALUE)

HOP

[not used alone]

:<cmd>

Select Frequency Hopping sweep parameter entry where <cmd> is replaced by TIME.

SWEEP (continued)

:START Select start value of the parameter to be swept.
:STOP Select stop value of the parameter to be swept.

Data type : As used for the parameter
Allowed suffices : As used for the parameter
Default suffix : As used for the parameter

:STEP Select number of steps in the sweep.

Data type : Decimal Numeric Program Data
Allowed suffices : None
Default suffix : None

:TIME Select time per sweep step

Data type : Decimal Numeric Program Data
Allowed suffices : MS
Default suffix : MS

:MKRNUM Select marker

Data type : Decimal Numeric Program Data
Allowed suffices : None
Default suffix : None

:MKROFF Turn Current Marker OFF
:MKRON Turn Current Marker ON

Data type : None
Allowed suffices : None
Default suffix : None

:VALUE Set Value of Current Marker

Data type : Decimal Numeric Program Data
Allowed suffices : As used for the parameter
Default suffix : As used for the parameter

SWEEP?

Prepares message containing information on Sweep Mode, Type and Marker status in the following format:

`:SWEEP:MODE <mode>;TYPE <type>;<status>`

where: <mode> is a program mnemonic representing the sweep mode selected, <type> is a program mnemonic representing the sweep type selected and <status> is a program mnemonic indicating whether the Marker output is ON or OFF.

Sample responses: `:SWEEP:MODE CONT;TYPE CFRQ;MKROFF`
`:SWEEP:TYPE HOP:MODE SNGL`

SWEEP? (continued)

:CFRQ?

Prepares message containing information on Carrier Frequency Sweep settings in the following format:

```
:SWEEP:START <nr2>;STOP <nr2>;STEP <nr1>;TIME <nr1>;  
MKRNUM <nr1>;<status>;VALUE <nr2>
```

where: <status> is a program mnemonic indicating whether the selected Marker is ON or OFF.

Sample response: :SWEEP:START 1230000.0;STOP 1330000.0;STEP 100;
TIME 20;MKRNUM 2;MKRON;VALUE 1240000.0

:RFLV?

Prepares message containing information on RF Level Sweep settings in the following format:

```
:SWEEP:START <nr2>;STOP <nr2>;STEP <nr1>;TIME <nr1>;  
MKRNUM <nr1>;<status>;VALUE <nr2>
```

where: <status> is a program mnemonic indicating whether the selected Marker is ON or OFF.

Sample response: :SWEEP:START -107.0;STOP -27.0;STEP 80;TIME 50;
MKRNUM 2;MKRON;VALUE -97.0

:LFGF?

Prepares message containing information on LF Generator Frequency Sweep settings in the following format:

```
:SWEEP:START <nr2>;STOP <nr2>;STEP <nr1>;TIME <nr1>;  
MKRNUM <nr1>;<status>;VALUE <nr2>
```

where: <status> is a program mnemonic indicating whether the selected Marker is ON or OFF.

Sample response: :SWEEP:START 300.0;STOP 3000.0;STEP 2700;TIME 1;
MKRNUM 1;MKRON;VALUE 400.0

:LFGL?

Prepares message containing information on LF Generator Level Sweep settings in the following format:

```
:SWEEP:LFGL:START <nr2>;STOP <nr2>;STEP <nr1>;TIME <nr1>;  
MKRNUM <nr1>;<status>;VALUE <nr2>
```

where: <status> is a program mnemonic indicating whether the selected Marker is ON or OFF.

Sample response: :SWEEP:LFGL:START 1.0;STOP 120.0;STEP 120;TIME 10;
MKRNUM 2;MKRON;VALUE 5.0

SWEEP? (continued)

:INTF?

Prepares message containing information on Modulation Oscillator Frequency Sweep settings in the following format:

```
:SWEEP:INTF:START <nr2>;STOP <nr2>;STEP <nr1>;TIME <nr1>;  
MKRNUM <nr1>;<status>;VALUE <nr2>
```

where: <status> is a program mnemonic indicating whether the selected Marker is ON or OFF.

Sample response: :SWEEP:INTF:START 270.0;STOP 3300.0;STEP 500;TIME 1;
MKRNUM 4;MKRON;VALUE 2900.0

:HOP?

Prepares message containing information on Frequency Hopping Sweep in the following format:

```
:SWEEP:HOP:TIME<nr1>
```

SWEEP MODE/TYPE

SWEEP

:MODE

[not used alone]

Select Mode of operation for Sweep generator (single shot, continuous or externally triggered)

Data type : Character Program Data (any one of SNGL, CONT or EXT)
Allowed suffices : None
Default suffix : None

SWEEP (continued)

:TYPE Select Type of Sweep (Carrier Frequency, RF Level, LF Generator Frequency, LF Generator Level, Internal Modulation Oscillator Frequency or Off)

Data type : Character Program Data (any one of: OFF, CFRQ, RFLV, LFGF, LFGL, INTF1, INTF2, INTF3, INTF4, INTF5, INTF6, HOP or OFF)

Allowed suffices : None

Default suffix : None

Examples: :SWEEP:MODE SNGL;TYPE CFRQ
:SWEEP:MODE CONT;TYPE INTF4

SWEEP?

Prepares message containing information on Sweep Mode, Type and Marker status in the following format:

:SWEEP:MODE <mode>;TYPE <type>;<status>

where: <mode> is a program mnemonic representing the sweep mode selected, <Type> is a program mnemonic representing the sweep type selected and <status> is a program mnemonic indicating whether the Marker output is ON or OFF.

Examples: :SWEEP:MODE CONT;TYPE CFRQ;MKROFF
:SWEEP:TYPE HOP:MODE SNGL

SWEEP CONTROL

SWEEP

:GO	[not used alone] Commence Sweep
:CALC	Initiate Pre-calculation
:HALT	Pause Sweep
:CONT	Continue Sweep
:RESET	Reset sweep to Start Value
:XFER	Transfer Paused Value to Main Parameter
:UP	Go UP one sweep step while paused
:DN	Go DOWN one sweep step while paused

Data type : None

Allowed suffices : None

Default suffix : None

Examples: SWEEP:GO
SWEEP:RESET

FREQUENCY HOPPING

HOPSEQ

Enter frequency hopping sequence

Data type : Decimal Numeric Program data (can be multiple)
Allowed suffices : None
Default suffix : None

Examples: HOPSEQ 56, 72, 0, 4, 99, 72
HOPSEQ 255, 0, 4, 17, 23, 64, 72

HOPSEQ?

Returns a value 0-1024 indicating the number of steps in the Frequency Hopping Sequence.

MISCELLANEOUS COMMANDS

- IMODE** Select Instrument Mode
- Data type : Character Program Data (either NORMAL for signal generator operation or SWEEPER for swept operation)
Allowed suffices : None
Default suffix : None
- RPPR** Reset reverse power protection trip
- Data type : None
Allowed suffices : None
Default suffix : None
- FSTD** Select internal or external frequency standard
- Data type : Character program data (any one of INT0, INT1, INT5, INT10, EXT1, EXT5 or EXT10)
Allowed suffices : None
Default suffix : None
- Examples: FSTD INT10
FSTD EXT5
- FSTD?** Prepares message containing information on frequency standard selection in the format:
- :FSTD <char>
- Example: :FSTD EXT10
- BLANK** Blank or unblank various parts of the display. The number sent after the command determines the action to be taken as follows:
- 0 blank or unblank the Carrier Frequency display
 - 1 blank or unblank the RF Level display
 - 2 blank or unblank the Modulation Frequency display
 - 3 blank or unblank the Modulation display
 - 4 blank all displays
- Data type : Decimal Numeric Program Data (any one of 0, 1, 2, 3 or 4)
Allowed suffices : None
Default suffix : None
- Examples: BLANK 0
BLANK 4
- BACKL** [not used alone]
:ON Backlighting On
:OFF Backlighting Off
- Data type : None
Allowed suffices : None
Default suffix : None
- Examples: BACKL:ON
BACKL:OFF

TIME?

Prepares message containing information on current real time clock time setting in the format:

<HH:MM>

where: <HH:MM> is string program data representing the time in hours and minutes using the 24 hour clock notation.

Example: "17:55"

DATE?

Prepares message containing information on current real time clock date setting in the format:

<YYYY-MM-DD>

where: <YYYY-MM-DD> is string program data representing the date in ISO notation (year number, month number, day number).

Example: "1990-04-01"

OPER?

Prepares message containing information on total operating hours in the following format:

<nr2>

Example: 1453.0

ELAPSED?

Prepares message containing information on elapsed operating hours since last reset in the following format:

<nr2>

Example: 454.5

ERROR?

Prepares message containing the number of the next error in the error queue in the following format:

<nr1>

The numeric value returned is either that of the next error number or 0 if the queue is empty or 255 if the queue is full

Example: 37

DEVTRG

Set Device Trigger Function (action on receipt of *TRG)

Data type : Character Program Data (any one of: SEQT, FLSWP, SSSWP or VOID)

Allowed suffices : None
Default suffix : None

EXTTRG

Set External Trigger Function (action on Low signal being applied to External Trigger Socket).

Data type : Character Program Data (any one of: SEQT, FLSWP, SSSWP, MEMUP, MEMDN or VOID)
Allowed suffices : None
Default suffix : None

Examples: DEVTRG SEQT
EXTTRG MEMUP

KLOCK

Disables keyboard entry except RPP Reset and Go to Local

Data type : None
Allowed suffices : None
Default suffix : None

KUNLOCK

Enables keyboard entry

Data type : None
Allowed suffices : None
Default suffix : None

THE STATUS BYTE

The Status Byte provides information about events and conditions within the instrument. It may be read by a conventional Serial Poll or its value obtained as a response to the *STB? query. Bits 0 to 5 and bit 7 are each single bit Summary Messages which may be of two types (or not used at all).

- (i) Query Status - a '1' indicates that an associated Queue is non-empty and has data available to be read.
- (ii) Status Register Summary - reports the occurrence of an enabled event monitored by a Status Register Structure.

The Service Request Enable Register determines which of the bits can generate an SRQ, this register may be set by *SRE or read by *SRE?. If the bitwise -AND of the Status Byte and the Enable Register is non-zero the Flag Master Summary Status (<mss>) is True. Bit 6 of the Status byte value read by *STB? holds <mss>. However bit 6 of the Status Byte when Serial Polled is the Request For Service bit used to determine which device on the Bus has asserted SRQ, and is cleared by a Serial Poll.

The IEEE 488.2 Standard defines bit 4 as Message Available (<mav>), the Queue Summary for the Output Buffer, indicating whether any part of a Response Messages is available to be read. Bit 5 is the Event Summary Bit (<esb>), the Summary Message from the Standard Event Status Register.

In 2050 series, bit 7 is a Queue Summary for the Error Queue. Bits 1, 2, and 3 are Status summaries for the Instrument Status, Coupling Status and Hardware Status Registers. Bit 0 is unused.

STATUS DATA STRUCTURE - REGISTER MODEL

Below is a generalised model of the Register Set which funnels the monitored data into a single summary bit to set the appropriate bit in the Status Byte.

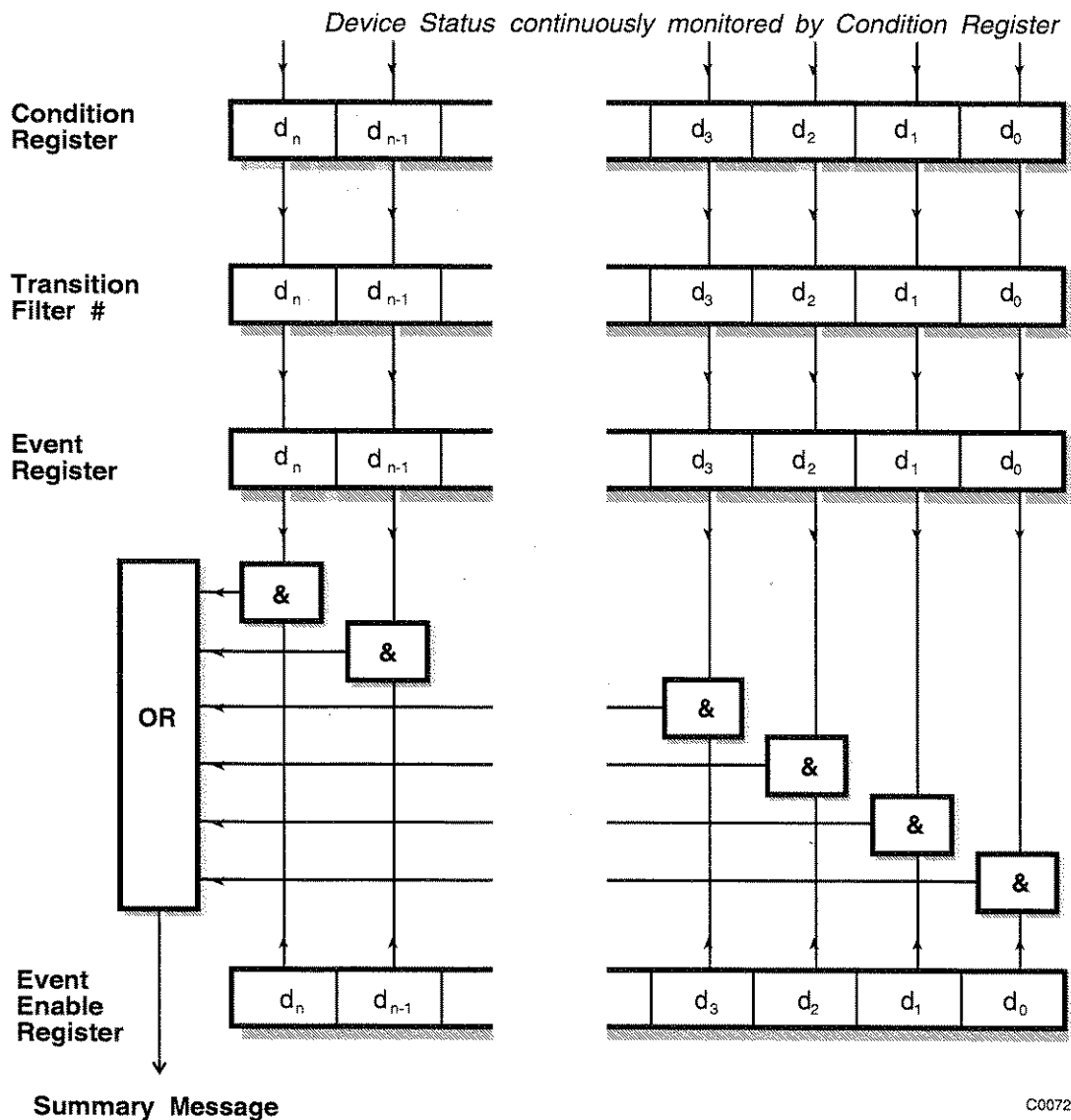

Notes...

The Device Status is continuously monitored by the Condition Register. If a Query to read a Condition Register is provided, the Response represents the Status of the instrument at the moment the Response is generated. A Condition Register cannot be written to.

The Transition Filter determines which transition of the Condition Register data bits will set the corresponding bit in the Event Register. Either positive-going, negative-going or both transitions can set bits in an Event Register. But in the 2050 series the Transition Filters are pre-set as either Positive or Negative, as described in the following pages.

The bits in an Event Register are "latched". Once set they remain set, regardless of subsequent changes in the associated condition bit until the Event Register is cleared by being read or by the *CLS common command. Once cleared, an Event Register bit will only be set again if the appropriate change in the Condition bit occurs.

The Event Enable Register may be both written to and read from. It is bitwise AND-ed with the Event Register and if the result is non-zero the Summary Message is true, otherwise the Summary Message is false. Enable Registers are not affected by *CLS but are however clear at power-on.

STANDARD EVENT REGISTERS

This Register is defined by IEEE 488.2 and each bit has the meaning shown below:-

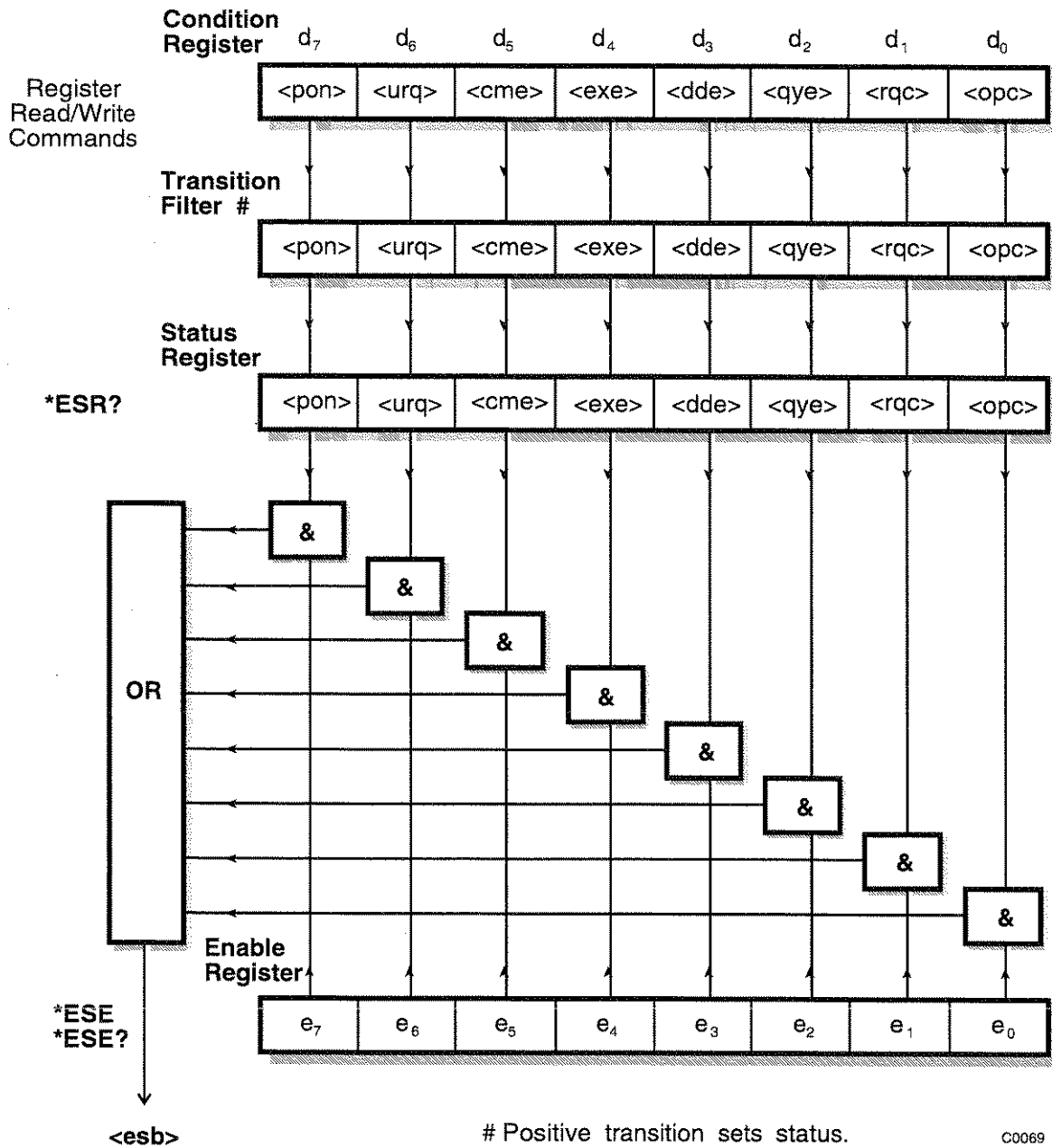

- $\langle \text{pon} \rangle$ power on
- $\langle \text{urq} \rangle$ user request - used by screen edit facility
- $\langle \text{cme} \rangle$ command error
- $\langle \text{exe} \rangle$ execution error
- $\langle \text{dde} \rangle$ device dependent error
- $\langle \text{qye} \rangle$ query error
- $\langle \text{rqc} \rangle$ request control - not implemented in this product
- $\langle \text{opc} \rangle$ operation complete - set in response to the *OPC command for synchronisation.
- $\langle \text{esb} \rangle$ standard event register summary bit

HARDWARE EVENT REGISTERS

This is a device dependant Register and the bits have meanings as shown in the list at the bottom of the page.

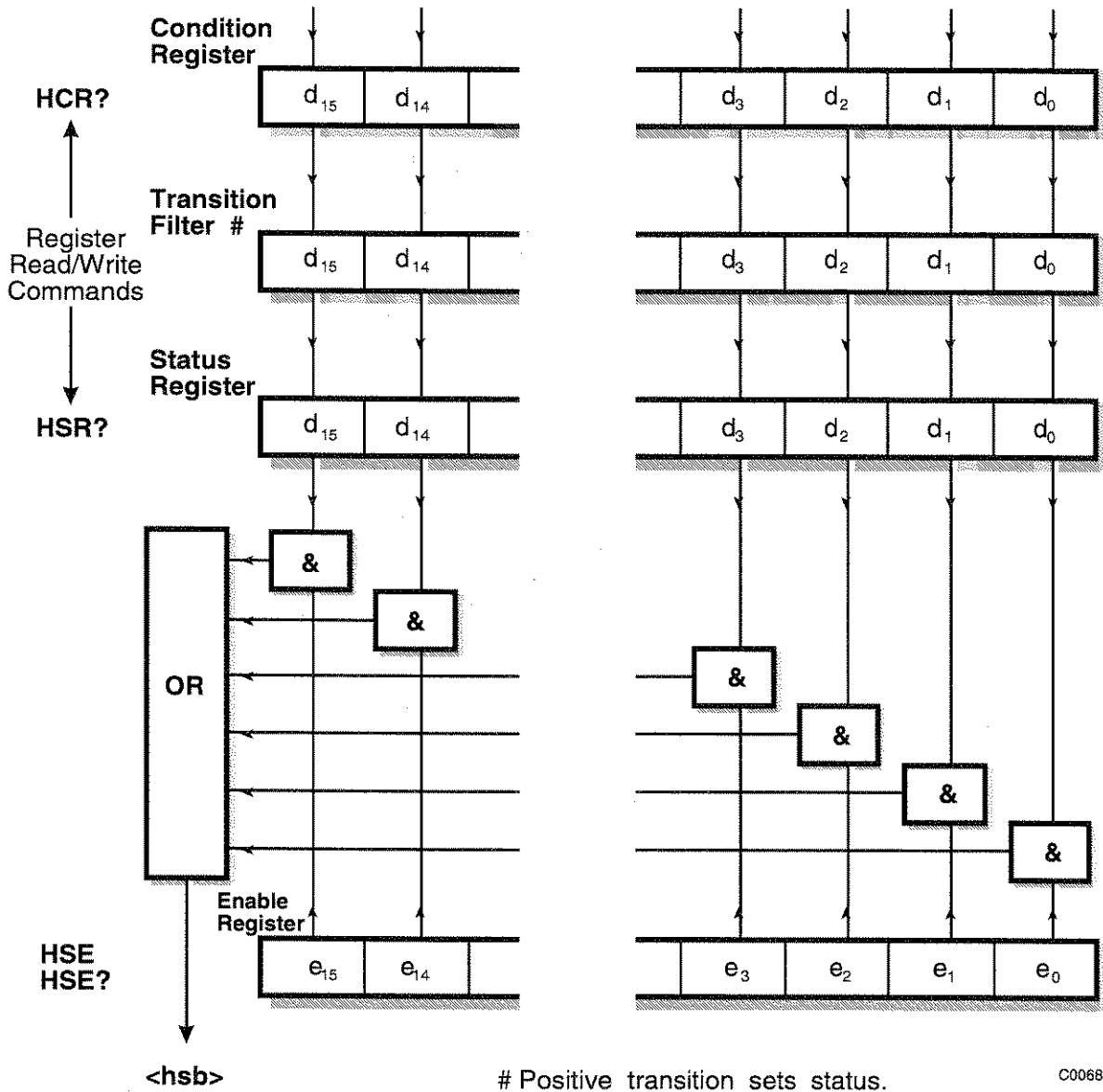

- d_0 reverse power protection tripped
- d_1 fractional-n system out-of-lock
- d_2 vcxo out-of-lock
- d_3 frequency standard missing
- d_4 external mod 1 alc loop signal too low
- d_5 external mod 1 alc loop signal too high
- d_6 external mod 2 alc loop signal too low
- d_7 external mod 2 alc loop signal too high

- d_8 IF loop out of lock
- d_9 not used
- d_{10} 16/26 reference too high
- d_{11} 16/26 reference too low
- d_{12} IQ modulator calibration required
- d_{13} not used
- d_{14} RF level uncalibrated
- d_{15} Extended hysteresis

<hsb> hardware event register summary bit

COUPLING EVENT REGISTERS

This is a device dependant Register and the bits have meanings as shown in the list at the bottom of the page.

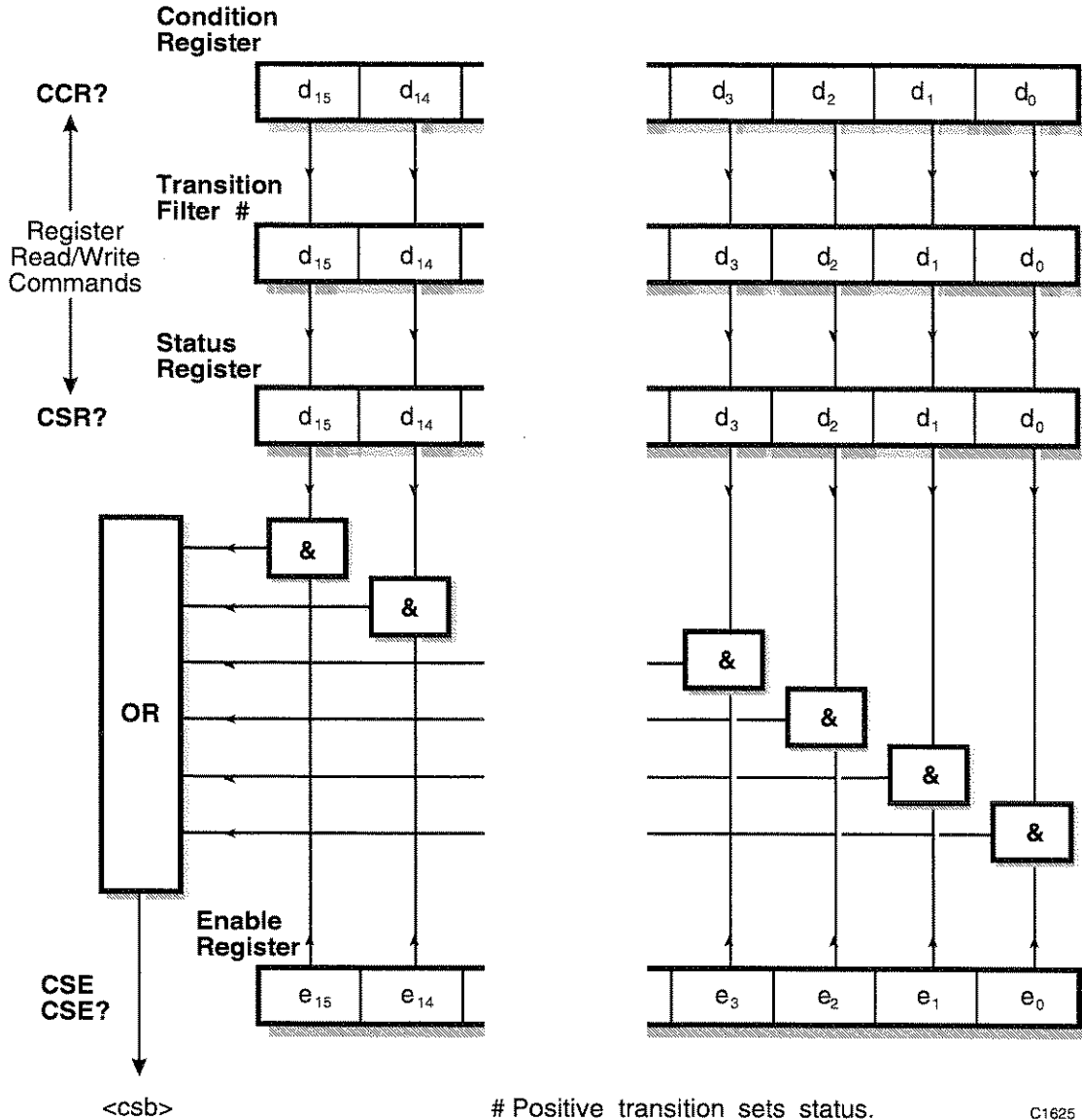

- d⁰ rf level restricted by requested am
 - d¹ fm restricted by requested carrier frequency
 - d² widebandfm restricted by requested carrier frequency
 - d³ am2 depth restricted by requested am1 depth
 - d⁴ fm2 deviation restricted by requested fm1 deviation
 - d⁵ pm2 deviation restricted by requested pm1 deviation
 - d⁶ number of sweep steps restricted by other parameters
 - d⁷ carrier restricted by modulation mode
 - d⁸ rf level restricted by modulation mode
- <csb> coupling event register summary bit

INSTRUMENT EVENT REGISTERS

This is a device dependant Register and the bits have meanings as shown in the list at the bottom of the page.

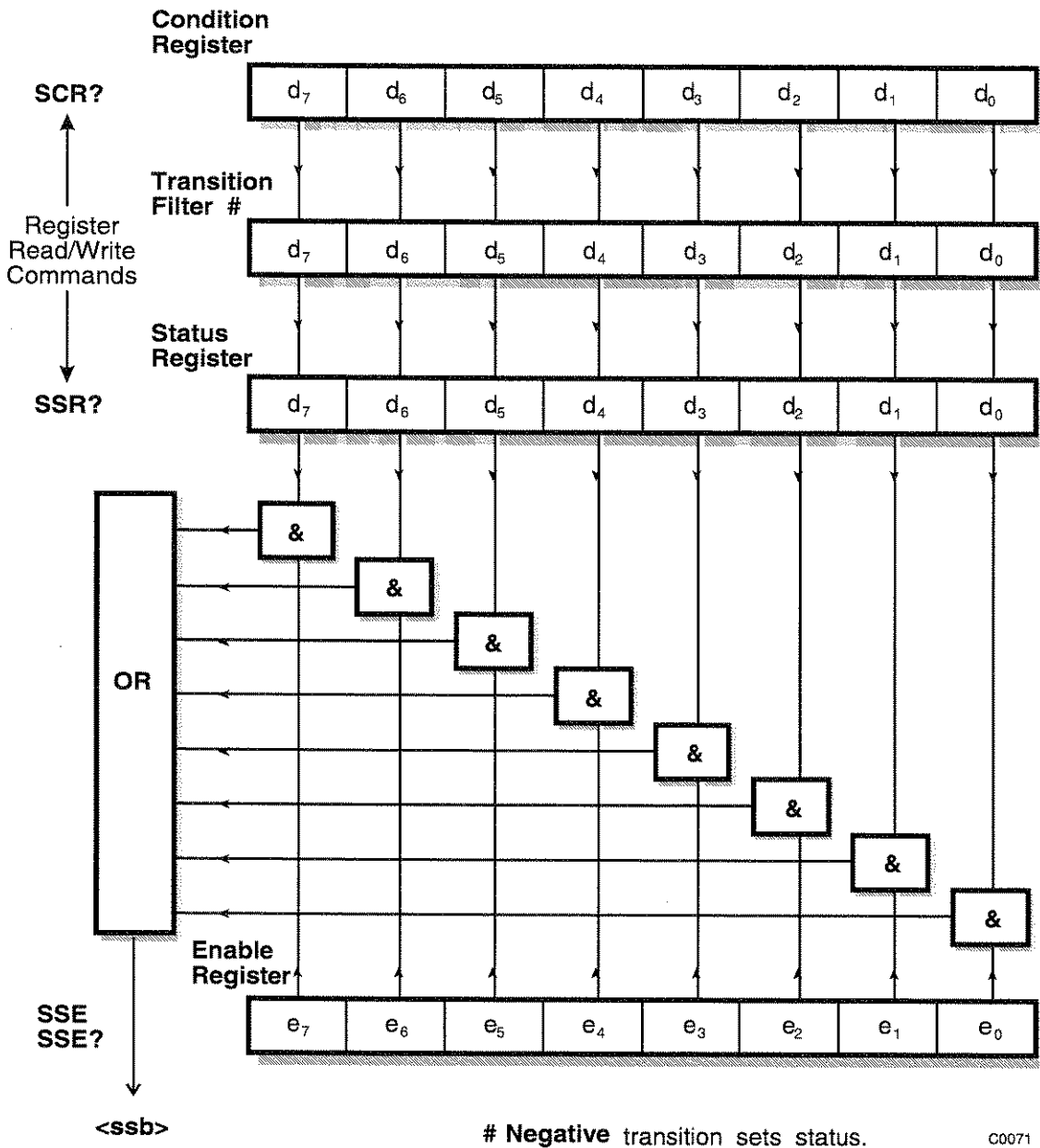

	<u>Condition (*SCR?)</u>	<u>Event Status (*SSR?)</u>
d ⁰	sweep in progress	end of sweep
d ¹	sending tones	tones sent
d ²	selfcal in progress	selfcal completed
d ³	dc fm null in progress	dc fm null completed
d ⁴	not used	not used
d ⁵	not used	not used
d ⁶	not used	not used
d ⁷	not used	not used
<ssb>	instrument event register summary bit	

QUEUE FLAG DETAILS

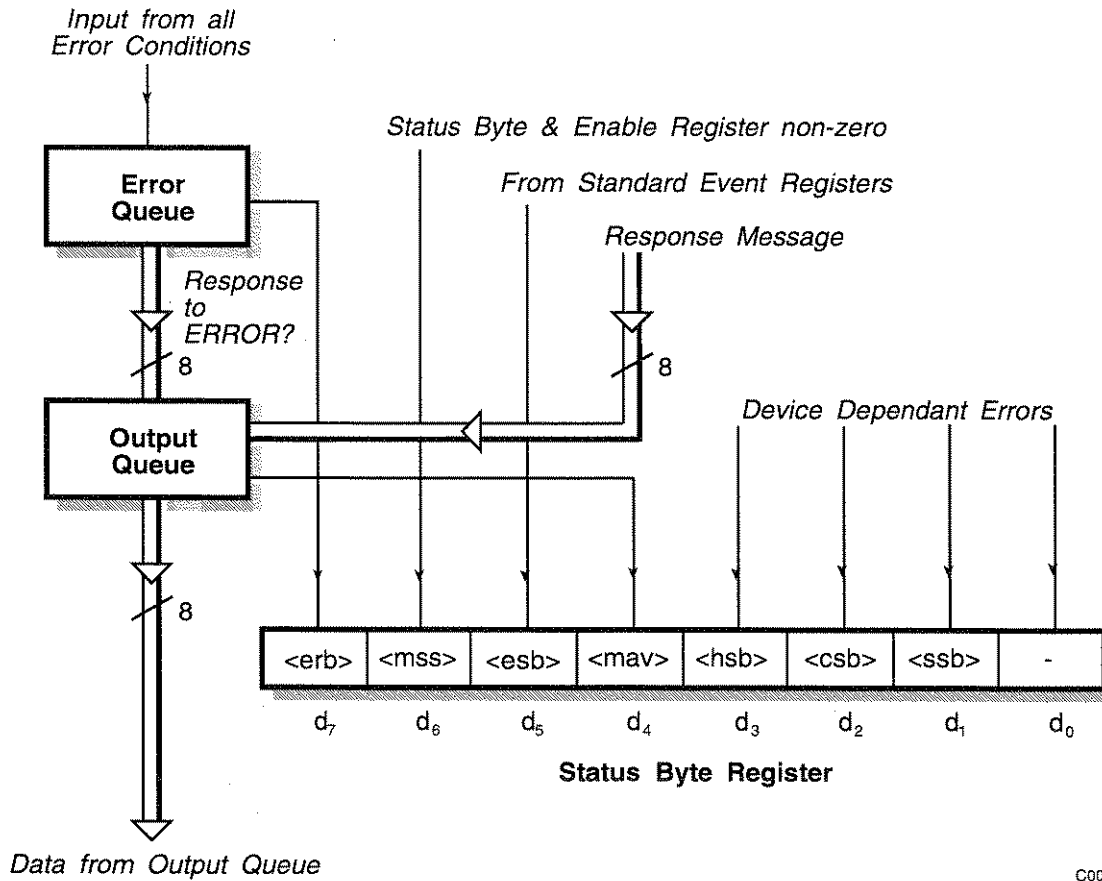

C0075

The <mav> status bit is set when one or more bytes are available to be read from the Output Queue.

The <erb> status bit is set when one or more errors are present in the Error Queue. The ERROR? query will place a nr1 response message in the Output Queue representing the Error at the head of the queue, if the queue is empty then this message will be 0.

STATUS BYTE WHEN READ BY *STB?

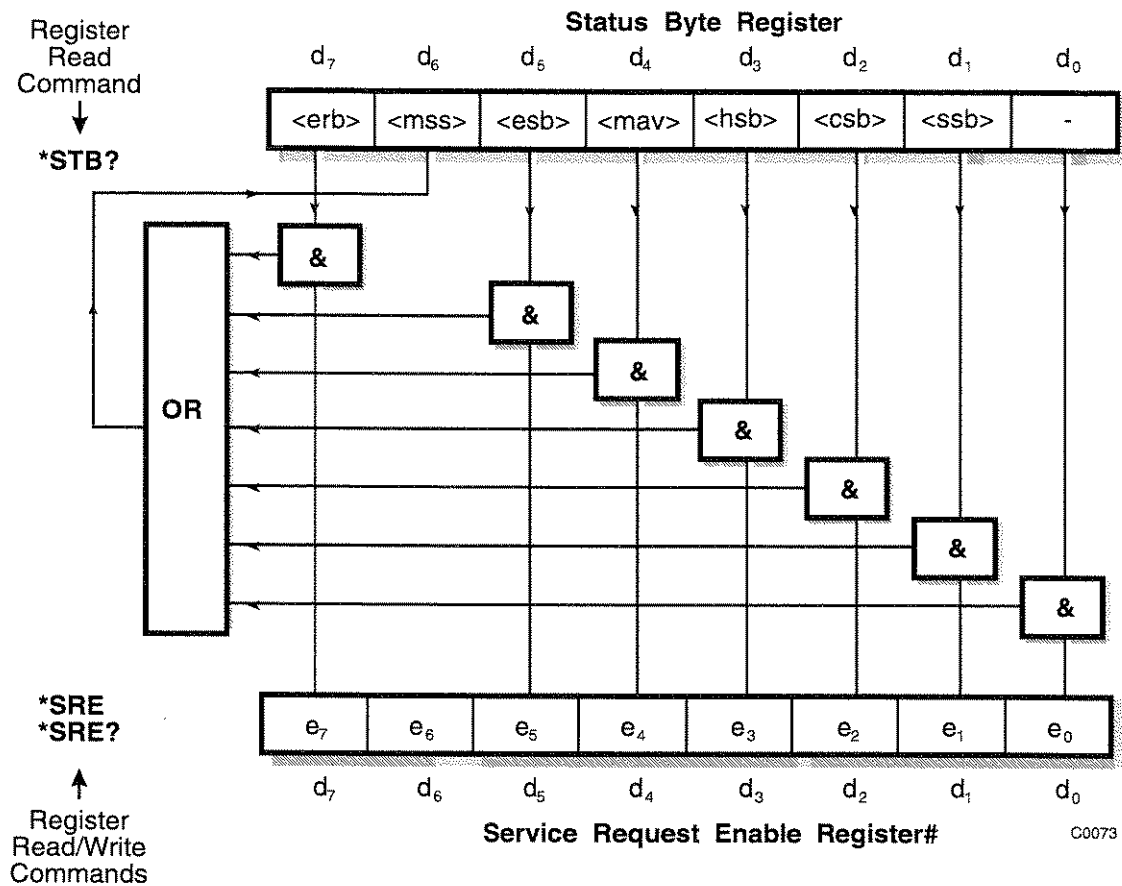

Bit 6 in this register ignores data sent by *SRE and always returns 0 in response to *SRE?

<rqs>, <esb> and <mav> are defined in IEEE 488.2

<erb> is a device defined queue summary bit indicating that the error queue is non-empty.

<mss> is true when (Status Byte) AND (Enable register) > 0.

<esb> is the standard event register summary bit.

<mav> is 'message available' indicating that the output queue is non-empty.

<hsb> is 'hardware status' summary bit

<csb> is 'coupling status' summary bit

<ssb> is 'instrument status' summary bit

Note...

The Status Byte Register is Not cleared by the *STB? query.

STATUS BYTE WHEN READ BY SERIAL POLL

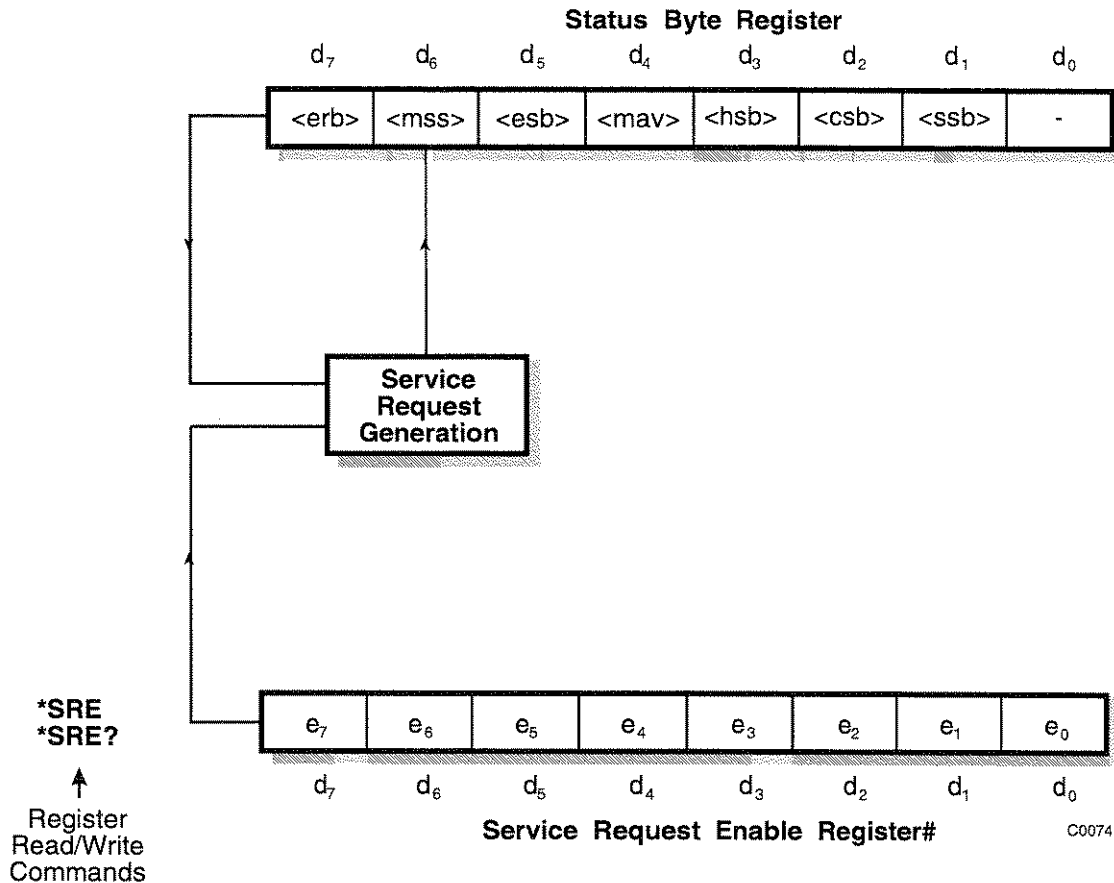

Bit 6 in this register ignores data sent by *SRE and always returns 0 in response to *SRE?

<erb> is a device defined queue summary bit indicating that the error queue is non-empty.

<rqs> is set by a request for service and is cleared by the poll.

<esb> is the standard event register summary bit.

<mav> is 'message available' indicating that the output queue is non-empty.

<hsb> is 'hardware status' summary bit

<csb> is 'coupling status' summary bit

<ssb> is 'instrument status' summary bit

<rqs>, <esb> and <mav> are defined in IEEE 488.2

<rqs> (request for service) will produce an SRQ at the controller. It is set by a change to either the Status Byte or the Service Enable Register that results in a New Reason for Service. It is cleared when <mss> goes FALSE (i.e. no reason for service) or by Serial Poll.

SUMMARY OF STATUS REPORTING COMMANDS AND QUERIES

*CLS	Clears Status Registers and the Error Queue
*ESE<nrf>	Writes to Standard Event Enable Register
*ESE?	Reads from Standard Event Enable Register
*ESR?	Reads from Standard Event Status Register
*SRE<nrf>	Writes to Service Request Enable Register
*SRE?	Reads from Service Request Enable Register
*STB?	Reads from Status Byte Register
CCR?	Reads from Coupling Condition Register
CSE<nrf>	Writes to Coupling Status Enable Register
CSE?	Reads from Coupling Status Enable Register
CSR?	Reads from Coupling Status Register
HCR?	Reads from Hardware Condition Register
HSE<nrf>	Writes to Hardware Status Enable Register
HSE?	Reads from Hardware Status Enable Register
HSR?	Reads from Hardware Status Register
SCR?	Reads from Instrument Condition Register
SSE<nrf>	Writes to Instrument State Enable Register
SSE?	Reads from Instrument State Enable Register
SSR?	Reads from Instrument State Status Register
<nrf>	Decimal Numeric Program Data

All of the above queries respond with a nr1 numeric format.

Chapter 4-1

BRIEF TECHNICAL DESCRIPTION

INTRODUCTION

The 2050 series signal generators cover a wide range of frequencies from 10 kHz to 1.35 GHz (2050), 10 kHz to 2.7 GHz (2051) and 10 kHz to 5.4 GHz (2052). Output levels from -144 or -138 dBm to +13 dBm are available. The simplified block schematic diagram for the instrument is shown in Fig. 4-1.

MODULATION

The carrier frequency can be frequency, phase or amplitude modulated from internal or external modulation sources. A maximum of four modulation channels can be made available by the use of the internal oscillator and a second optional internal oscillator together with two external modulation signals applied to the EXT MOD 1 INPUT and EXT MOD 2 INPUT connectors on the front panel.

In vector modulation IQ modulation is provided from 10 MHz up to 2.7 GHz by frequency conversion of 1 of 4 IFs to the required output frequency. In digital modulation a vector modulated RF carrier is generated from data inputs.

FREQUENCY GENERATION

Four voltage controlled oscillators (VCOs) covering the frequency range 675 to 1350 MHz are phase locked to a 10 MHz oven controlled crystal oscillator using a fractional-N synthesizer system. Additional frequency coverage is achieved by means of frequency division or multiplication. Low frequencies are generated by a beat frequency oscillator (BFO) system.

DISPLAY

The display is a high definition dot matrix liquid crystal panel with backlighting to cater for variations in ambient light conditions. The display can be adjusted for both contrast and brightness.

CONTROL

The 2050 series are menu driven instruments. Main menus are displayed by the use of hard keys, and parameters are changed by means of soft keys which change as the menu changes. Internal control of the instruments is achieved by a microprocessor which receives data from the various controls and sends instructions via an internal 8-bit data bus to the signal processing circuits.

The instruments can also be controlled by the built in general purpose interface bus (GPIB). This facility enables the instruments to be used both as manually operated bench mounted instruments or as part of a fully automated test system.

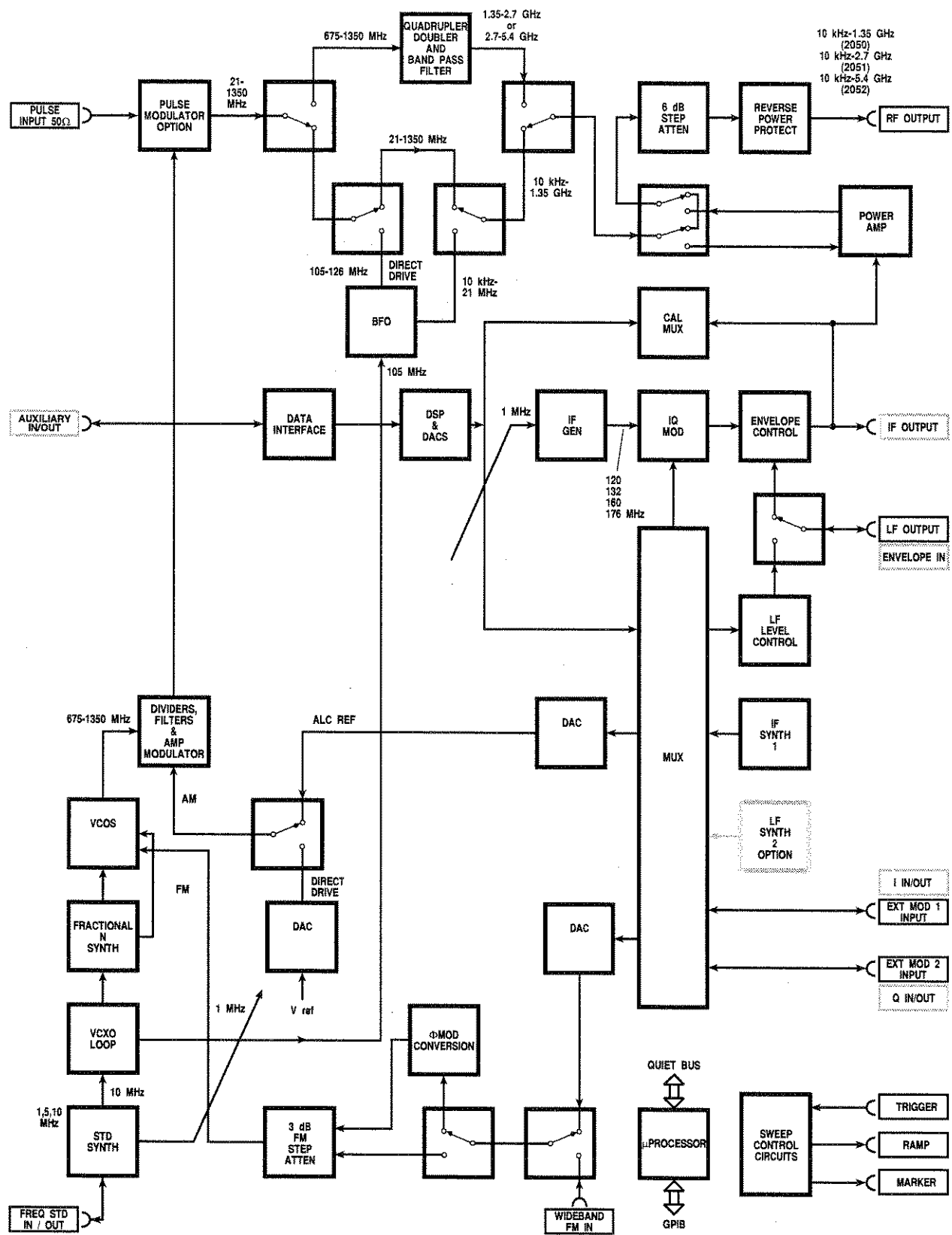

Fig. 4-1-1 Block schematic diagram

Chapter 5-1

ACCEPTANCE TESTING

CONTENTS

	PAGE
INTRODUCTION	5-1-3
RECOMMENDED TEST EQUIPMENT	5-1-3
TEST PROCEDURES	5-1-4
RF OUTPUT	5-1-4
ALC linearity	5-1-5
Attenuator accuracy	5-1-6
Alternative attenuator functional check	5-1-7
CARRIER FREQUENCY ACCURACY	5-1-8
MODULATION OSCILLATOR	5-1-9
Modulation oscillator frequencies	5-1-9
Modulation oscillator distortion	5-1-10
LF OUTPUT	5-1-11
Level accuracy	5-1-11
Frequency response	5-1-12
EXTERNAL MODULATION	5-1-13
Mod ALC on flatness	5-1-13
Modulation ALC distortion	5-1-14
INTERNAL AM DEPTH AND DISTORTION	5-1-15
AM scale shape	5-1-16
Phase modulation on AM	5-1-16
EXTERNAL AM	5-1-17
INTERNAL FM DEVIATION	5-1-18
FM attenuator	5-1-18
FM scale shape	5-1-19
EXTERNAL FM	5-1-20
CARRIER FREQUENCY OFFSET	5-1-22
INTERNAL PHASE MODULATION	5-1-23
Internal phase modulation flatness	5-1-23
SPECTRAL PURITY	5-1-25
Residual FM	5-1-25
Carrier harmonics	5-1-26
Carrier sub-harmonics (2051 and 2052 only)	5-1-26
Non-harmonics	5-1-27
SSB phase noise	5-1-28
DIGITAL MODULATION MODE	5-1-28
IQ outputs	5-1-29
Level accuracy	5-1-31
Modulation accuracy	5-1-34
Burst control	5-1-39
VECTOR MODULATION MODE	5-1-40
Vector input impedance	5-1-40
DC vector accuracy	5-1-41
Vector bandwidth	5-1-42
ENVELOPE CONTROL	5-1-43
Linearity	5-1-43
On/off ratio	5-1-44
Envelope delay	5-1-45
IF OUTPUT	5-1-46
LAST COMPLETE CHECK DATE	5-1-47
CALIBRATION DUE DATE	5-1-47
REAL TIME CLOCK BATTERY	5-1-47

LIST OF TABLES

Table 5-1-1	Recommended test equipment	5-1-3
Table 5-1-2	Frequency settings for output levels	5-1-5
Table 5-1-3	Attenuator frequency settings	5-1-7
Table 5-1-4	Carrier frequencies.....	5-1-8
Table 5-1-5	Modulation oscillator frequencies	5-1-9
Table 5-1-6	Distortion frequency settings	5-1-10
Table 5-1-7	Level accuracy output levels.....	5-1-12
Table 5-1-8	Frequency response test frequencies.....	5-1-12
Table 5-1-9	External modulation frequencies	5-1-14
Table 5-1-10	AM depth and distortion frequencies.....	5-1-16
Table 5-1-11	AM depths	5-1-16
Table 5-1-12	External AM test frequencies	5-1-17
Table 5-1-13	FM attenuator deviations	5-1-18
Table 5-1-14	FM scale shape deviations	5-1-19
Table 5-1-15	External FM response frequencies.....	5-1-21
Table 5-1-16	Modulation source frequencies.....	5-1-24
Table 5-1-17	Carrier harmonic frequencies.....	5-1-26
Table 5-1-18	Carrier sub-harmonic frequencies.....	5-1-27
Table 5-1-19	Carrier non-harmonic frequencies	5-1-27
Table 5-1-20	Calculating level accuracy in digital modulation mode.....	5-1-32
Table 5-1-21	Vector bandwidth settings	5-1-42

LIST OF FIGURES

Fig. 5-1-1	RF output test set-up	5-1-5
Fig. 5-1-2	Attenuator accuracy test set-up	5-1-6
Fig. 5-1-3	Carrier frequency accuracy test set-up	5-1-8
Fig. 5-1-4	Modulation oscillator frequencies test set-up.....	5-1-9
Fig. 5-1-5	Modulation oscillator distortion test set-up.....	5-1-10
Fig. 5-1-6	Level accuracy test set-up	5-1-11
Fig. 5-1-7	External modulation test set-up.....	5-1-13
Fig. 5-1-8	Modulation ALC distortion test set-up	5-1-14
Fig. 5-1-9	Internal AM depth and distortion test set-up.....	5-1-15
Fig. 5-1-10	External AM test set-up.....	5-1-17
Fig. 5-1-11	External FM test set-up	5-1-20
Fig. 5-1-12	Residual FM test set-up.....	5-1-25
Fig. 5-1-13	Carrier harmonics test set-up.....	5-1-26
Fig. 5-1-14	SSB phase noise test set-up.....	5-1-28
Fig. 5-1-15	IQ output test set-up	5-1-29
Fig. 5-1-16	8PSK constellation	5-1-29
Fig. 5-1-17	OQPSK constellation	5-1-30
Fig. 5-1-18	16 QAM constellation	5-1-30
Fig. 5-1-19	Level accuracy test set-up	5-1-33
Fig. 5-1-20	Spectrum analyzer trace for a carrier leak waveform.....	5-1-35
Fig. 5-1-21	Spectrum analyzer trace for signal compression waveform.....	5-1-36
Fig. 5-1-22	Spectrum analyzer trace for IQ channel balance waveform.....	5-1-37
Fig. 5-1-23	Channel frequency response test set-up	5-1-37
Fig. 5-1-24	Burst control test set-up	5-1-39
Fig. 5-1-25	Linearity test set-up.....	5-1-43
Fig. 5-1-26	Envelope delay test set-up.....	5-1-45
Fig. 5-1-27	IF output level test set-up	5-1-46

INTRODUCTION

Test procedures described in this chapter may be simplified and of restricted range compared with those that relate to the generally more comprehensive factory test facilities which are necessary to demonstrate complete compliance with the specifications.

Performance limits quoted are for guidance and should not be taken as guaranteed performance specifications unless they are also quoted under 'Performance Data' in Chapter 1.

When making tests to verify that the instrument meets the stated performance limits, always allow for the uncertainty of the test equipment.

For those signal generators with options fitted, the appendixes at the end of this Chapter and the Annexes at the end of this manual must be referred to.

RECOMMENDED TEST EQUIPMENT

The test equipment recommended for acceptance testing is shown in Table 5-1-1. Alternative equipment may be used provided it complies with the stated minimum specification.

TABLE 5-1-1 RECOMMENDED TEST EQUIPMENT

Description	Minimum specification	Example
Power meter	± 0.1 dB from 10 kHz to 5.4 GHz	IFR [†] 6960B and 6910 or 6912 sensor
Measuring receiver	0 dBm to -127 dBm; 2.5 to 1300 MHz	HP8902A and 11722A sensor and 11793A down converter#
Signal generator	8 dBm from 32.5 MHz to 5.4 GHz	IFR [†] 2032
Frequency counter	10 Hz to 5.4 GHz	ETP 535B or IFR [†] 2440
Audio analyzer	Capable of measuring THD below 0.03% from 50 Hz to 20 kHz. Capable of measuring 0.5 mV $\pm 3\%$ and levels at 10 Hz	HP8903B or Rhode & Schwarz UPA3
Digital multimeter	DC to 500 kHz, 1 mV to 5 V Resistance measurement capability	Datron 1061A
Modulation meter	AM, FM and Φ M. 1.5 MHz to 1 GHz. Accuracy better than 1.1%. Modulation freqs from 30 Hz to 50 kHz. Capable of measuring Residual FM less than 7 Hz.	IFR [†] 2305 plus distortion option*
Spectrum analyzer	10 kHz to 16.2 GHz Dynamic range greater than 80 dB Capable of measuring less than -70 dBm.	IFR [†] 2386
Break-out box		IFR [†] 44991-144
Function generator	DC to 10 MHz sine ± 0.6 dB flatness	HP3325B

[†]IFR Ltd was previously known as Marconi Instruments Ltd

* The distortion option of the 2305 Modulation Meter allows modulation distortion tests to be carried out with greater ease. If a 2305 with a distortion option is not available, the Audio Analyzer may be connected to the Modulation Meter LF output and set to measure distortion.

If receiver and down converter are not available, an alternative procedure to ensure attenuator pad accuracy using a power meter is given.

TEST PROCEDURES

Before each test, it is recommended that the UUT is reset to its switch-on conditions which are as follows:

Carrier freq	1.35 GHz (2050), 2.7 GHz (2051), 5.4 GHz (2052)
RF level	-144 dBm
FM	0 Hz ON
Single modulation mode	
Modulation	ENABLED

RF OUTPUT

SPECIFICATION	
Level range:	-127 dBm to +13 dBm (usable to -144 dBm)
Accuracy:	<p style="text-align: center;">(2050, 2051 and 2052)</p> <p>±0.85 dB from 10 kHz to 1.35 GHz at levels >-127 dBm ±0.50 dB from 10 kHz to 1.35 GHz at levels >0 dBm</p> <p style="text-align: center;">(2051 and 2052)</p> <p>±1.0 dB from 1.35 GHz to 2.7 GHz at levels >-127 dBm ±0.7 dB from 1.35 GHz to 2.7 GHz at levels >0 dBm</p> <p style="text-align: center;">(2052 only)</p> <p>±1.5 dB from 2.7 GHz to 5.4 GHz at levels >-100 dBm ±1.5 dB from 2.7 GHz to 5.4 GHz at levels >-50 dBm ±1.0 dB from 2.7 GHz to 5.4 GHz at levels >0 dBm</p>

TEST EQUIPMENT		
Description	Minimum specification	Example
RF power meter	±0.1 dB from 30 kHz to 2.7 GHz	IFR 6960B and 6910 or 6912 sensor
Measuring receiver	0 dBm to -127 dBm; 2.5 MHz to 1300 MHz	HP 8902A and 11722A sensor and 11793A down converter
Signal generator	8 dBm from 32.5 MHz to 5.4 GHz	IFR 2032

TEST PROCEDURES

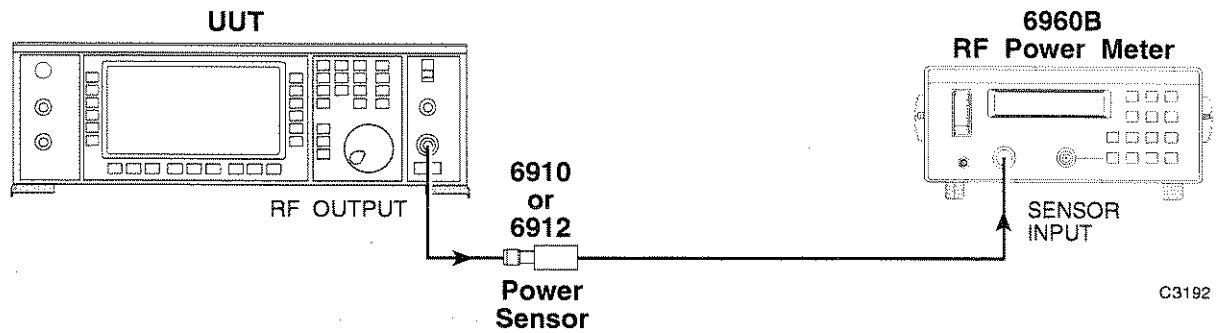

Fig. 5-1-1 RF output test set-up

- (1) Connect the test equipment as shown in Fig. 5-1-1.
- (2) Set the UUT to [RF Level] 0 dBm [Carrier Freq.] 30 kHz.
- (3) Check that the output level is within specification at the frequencies shown in Table 5-1-2.

When checking a 2052 signal generator, the 6912 sensor must be replaced with 6910 sensor for frequencies above 2700 MHz.

- (4) Set the UUT RF output to 7 dBm and repeat (3) above.
- (5) Set the UUT RF output to 13 dBm and repeat (3) above.

TABLE 5-1-2 FREQUENCY SETTINGS FOR OUTPUT LEVELS

		FREQUENCY (MHz)			
(2050/1/2)	1125	2025	2925	4425	
	0.03	1275	2175	3075	
	0.1	1350	2325	3225	
	75	2475	3375	4875	
225	(2051/2)	2625	3525	5025	
375	1351	2700	3675	5175	
525	1425		3825	5325	
675	1575	(2052)	3975	5400	
825	1725	2701	4125		
975	1875	2775	4275		

ALC linearity

- (1) Connect the test equipment as shown in Fig. 5-1-1.
- (2) Set the UUT to [RF Level] 0 dBm [Carrier Freq.] 2.5 MHz.
- (3) Increment the RF output of the UUT in 1 dB steps up to 12 dBm and in 0.1 dB steps up to 13 dBm, measuring the RF level at each step. Check that the RF output level variation is within ± 0.1 dB.
- (4) Set the UUT carrier frequency to 500 MHz and repeat (3) above.

- (5) Set the UUT carrier frequency to 2.7 GHz and repeat (3) above.
- (6) Replace the 6912 sensor with the 6910 sensor, set the UUT carrier frequency to 5.4 GHz and repeat (3) above.

Attenuator accuracy

The following test will confirm that the attenuator performs to the published performance specification. In the event of the receiver/down converter not being available, an alternative method to functionally test the attenuator is also suggested (see 'Alternative attenuator functional check' below).

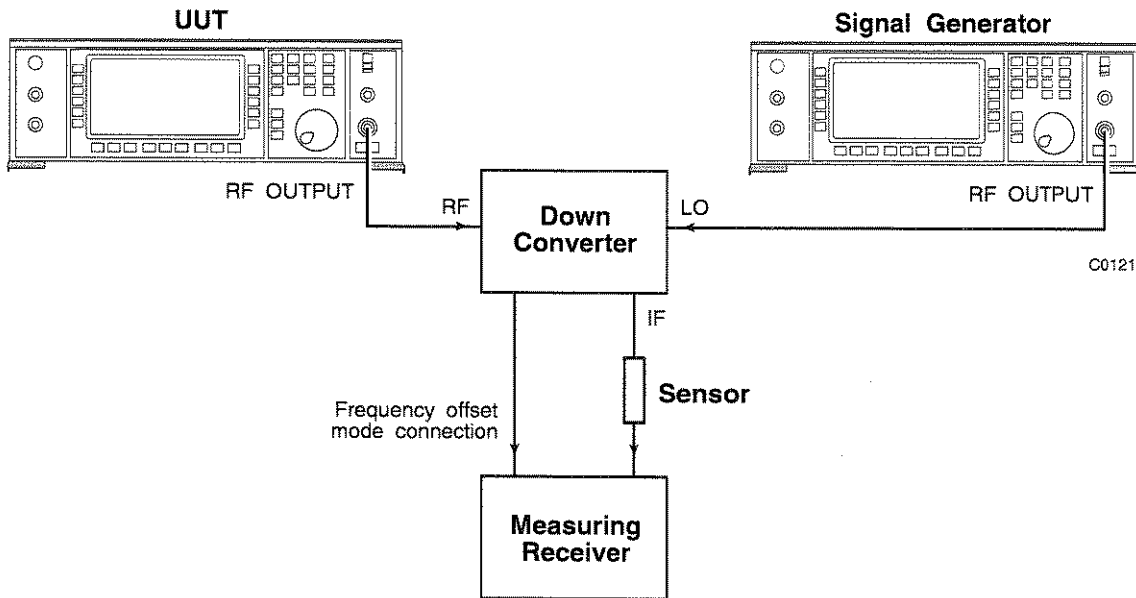

Fig. 5-1-2 Attenuator accuracy test set-up

- (1) Connect the test equipment as shown in Fig. 5-1-2.
- (2) Set the UUT to [RF Level] 0 dBm [Carrier Freq.] 2.5 MHz.
- (3) Tune the receiver to 2.5 MHz and measure the RF level.
- (4) Set the UUT to [RF Level] -6.1 dBm and measure the RF level.
- (5) Decrement the output of the UUT in 6 dB steps down to an RF level of -120.1 dBm measuring the RF level at each step. Check that the measured level is within specification.
- (6) Repeat (2) to (5) at the frequencies given in Table 5-1-3.
- (7) Set the local oscillator to +8 dBm at the frequencies indicated in brackets in Table 5-1-3.

TABLE 5-1-3 ATTENUATOR FREQUENCY SETTINGS

Frequency (MHz)		
2050/1/2	*2051/2	**2052
2.5	1725 (1662)	2775 (2712)
31	2700 (2637)	4125 (4062)
325		5400 (5337)
1125		
1275		

*At frequencies above 1300 MHz the down converter will automatically be enabled.
**At frequencies above 2700 MHz it is only necessary to test down to -96.1 dBm (determined by 8902 accuracy).

The frequency of the local oscillator will have to be entered on the receiver followed by the test frequency. This will automatically set the receiver to the required IF frequency.

Alternative attenuator functional check

- (1) Connect the test equipment as shown in Fig. 5-1-1.
- (2) Set the UUT to [*Carrier Freq.*] 1.35 GHz [*RF Level*] 13 dBm.
- (3) Set a reference on the power meter.
- (4) Using the latch poke facility on the UUT, select each attenuator pad individually as follows:

[UTIL] [*Utils. Menu 2*] [*Latch Data*] 95 [enter]
[*Decimal/Binary*]

The binary latch data will now appear in the bottom right-hand side of the display.

- (5) By using the [*Toggle Bit*] and the [*Cursor Left*] [*Cursor Right*] soft keys, select each attenuator pad in turn which should give the nominal readings on the power meter in the following sequence:

-24 dB -36 dB -6 dB -12 dB -24 dB -36 dB

Note that no software correction is applied to the attenuator when performing this test.

CARRIER FREQUENCY ACCURACY

SPECIFICATION	
Frequency range:	10 kHz to 1.35 GHz (2050) 10 kHz to 2.7 GHz (2051) 10 kHz to 5.4 GHz (2052)
Accuracy:	Determined by the frequency standard accuracy
Resolution:	0.1 Hz

TEST EQUIPMENT		
Description	Minimum specification	Example
Frequency counter	10 kHz to 5.4 GHz	ETP 535B or IFR 2440

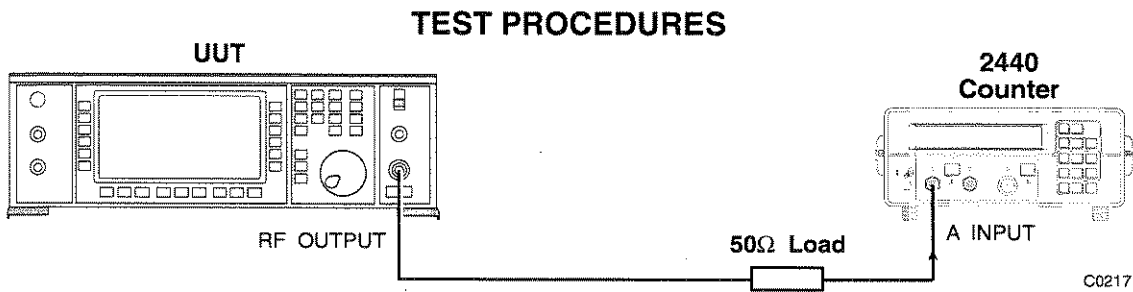

Fig. 5-1-3 Carrier frequency accuracy test set-up

- (1) Connect the test equipment as shown in Fig. 5-1-3.
- (2) Set the UUT to [RF Level] 0 dBm [Carrier Freq.] 10 kHz.
- (3) Referring to Table 5-1-4, check that the carrier frequencies can be selected correctly and are within specification. It will be necessary to disconnect the 50 ohm load and reconnect the UUT RF OUTPUT to the B input and C input where indicated.

TABLE 5-1-4 CARRIER FREQUENCIES

Carrier frequencies (Hz)			
(2050/1/2) A input	B input		(2052)
		805,306,368.0	2,700,001,000.0
		952,945,868.8	5,400,000,000.0
10,000.0	168,749,999.9	959,656,755.2	
4,226,750.0	337,499,999.9	1,134,139,801.6	
8,443,500.0	572,662,306.1	1,140,850,688.0	
12,660,250.0		1,145,324,612.2	
16,887,000.0	C input	1,348,888,166.4	
21,093,749.9			
21,039,750.0	674,999,999.9		
42,187,499.9	677,799,526.4	(2051/2)	
84,374,999.9	798,595,481.6	1,350,001,000.0	
		2,700,000,000.0	

MODULATION OSCILLATOR

SPECIFICATION	
Frequency range:	0.1 Hz to 500 kHz
Accuracy:	Equal to the frequency standard accuracy
Resolution:	0.1 Hz
Distortion:	Less than 0.1% THD at frequencies up to 20 kHz sine wave mode

TEST EQUIPMENT		
Description	Minimum specification	Example
Frequency counter	10 Hz to 500 kHz	ETP 535B or IFR 2440
Audio analyzer	Capable of measuring down to 0.03% THD from 100 Hz to 20 kHz	HP 8903B Rhode & Schwarz UPA 3

TEST PROCEDURES

Modulation oscillator frequencies

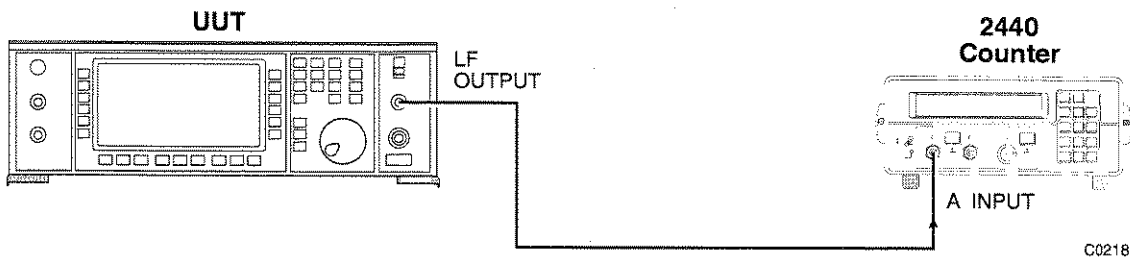

Fig. 5-1-4 Modulation oscillator frequencies test set-up

- (1) Connect the test equipment as shown in Fig. 5-1-4.
- (2) Set the UUT to [Source Freq: F4] 10 Hz.
- (3) Referring to Table 5-1-5, check that the oscillator frequencies can be selected correctly and are within specification.

TABLE 5-1-5 MODULATION OSCILLATOR FREQUENCIES

Modulation oscillator frequencies (Hz)	
10.00	279,620.20
139,810.10	500,000.00

Modulation oscillator distortion

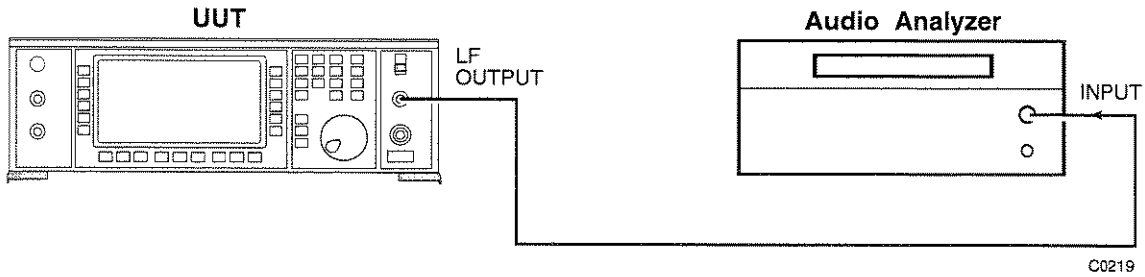

Fig. 5-1-5 Modulation oscillator distortion test set-up

- (1) Connect the test equipment as shown in Fig. 5-1-5.
- (2) Set the UUT to [Source Freq: F4] 100 Hz.
- (3) Check that the distortion measured on the audio analyzer at the frequencies indicated in Table 5-1-6 is less than 0.1%.

TABLE 5-1-6 DISTORTION FREQUENCY SETTINGS

Modulation oscillator frequencies

100 Hz	10 kHz
1 kHz	20 kHz

LF OUTPUT

SPECIFICATION	
Level accuracy:	±5% for levels above 50 mV ±10% for levels from 500 μV to 50 mV (With a load impedance >10 kΩ)
Frequency response:	Typically better than 1 dB from 0.1 Hz to 300 kHz

TEST EQUIPMENT		
Description	Minimum specification	Example
Digital multimeter	DC to 300 kHz, 1 mV to 5 V	Datron 1061A
Audio analyzer	Capable of measuring 0.5 mV ±3% and levels at 10 Hz	HP 8903B Rhode & Schwarz UPA3

TEST PROCEDURES

Level accuracy

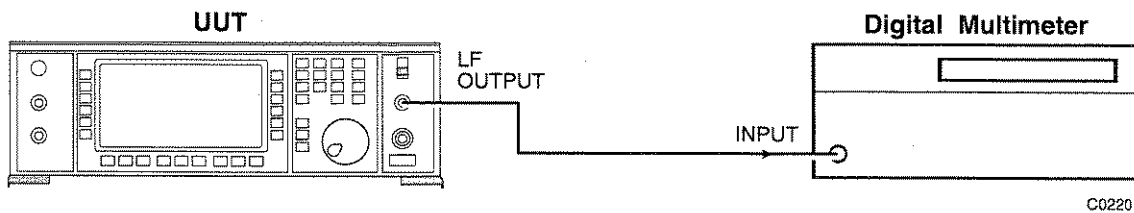

C0220

Fig. 5-1-6 Level accuracy test set-up

- (1) Connect the test equipment as shown in Fig. 5-1-6.
- (2) Set the UUT to give an LF output of 5 V at 1 kHz as follows:
[LF] [LF Gen] [LF Freq] 1 kHz [LF Level] 5 V
- (3) The level measured on the digital multimeter should read 5 V ±0.25 V.
- (4) Check the LF output of the UUT at the levels indicated in Table 5-1-7. Check that the measured levels are within specification.

TABLE 5-1-7 LEVEL ACCURACY OUTPUT LEVELS

LF output levels (V)		
5.0000	0.1000	0.0050
2.0000	0.0500	0.0020
1.0000	0.0200	0.0010
0.5000	0.0100	*0.0005
0.2000		

*For the last measurement it will be necessary to use the audio analyzer. Connect the test equipment as shown in Fig. 5-1-5.

Frequency response

- (1) Connect the test equipment as shown in Fig. 5-1-6.
- (2) Set the UUT to give an LF output of 1 V at 1 kHz on the first modulation oscillator (see 'Level accuracy' (2) above).
- (3) Reference this level on the digital voltmeter using the dB relative function.
- (4) Set the modulation oscillator to the frequencies given in Table 5-1-8 measuring the difference from the reference in (3) above which should be less than 1 dB.

TABLE 5-1-8 FREQUENCY RESPONSE TEST FREQUENCIES

Test frequencies		
*10 Hz	1 kHz ref	70 kHz
*30 Hz	10 kHz	100 kHz
*100 Hz	30 kHz	300 kHz

* For these measurements it will be necessary to use the audio analyzer. Connect the test equipment as shown in Fig. 5-1-5, referencing the audio analyzer at 1 kHz.

EXTERNAL MODULATION

SPECIFICATION	
	With ALC off, the modulation is calibrated for an input level of 1.0 V PD RMS
	With ALC on, the modulation is calibrated for input levels between 0.7 V and 1.4 V PD RMS
Distortion:	Less than 0.1% from 50 Hz to 20 kHz at 1 V RMS
Flatness:	Typical 1 dB bandwidth, 10 Hz to 500 kHz

TEST EQUIPMENT		
Description	Minimum specification	Example
Function generator	10 Hz to 500 kHz sine wave ± 0.6 dB flatness	HP 3325B
Digital multimeter	10 Hz to 500 kHz	Datron 1061A
Audio analyzer	Capable of measuring THD down to 0.03% from 50 Hz to 20 kHz	HP 8903B Rhode & Schwarz UPA3

Mod ALC on flatness

TEST PROCEDURES

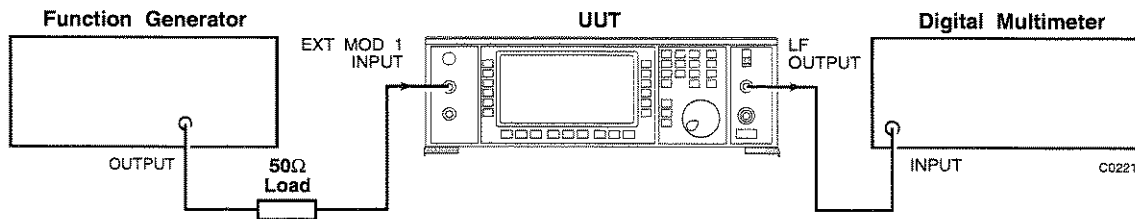

Fig. 5-1-7 External modulation test set-up

Mod input 1

- (1) Connect the test equipment as shown in Fig. 5-1-7.
- (2) Set the function generator to 1 V RMS sine wave output at a frequency of 1 kHz.
- (3) Set the UUT to EXT MOD 1 INPUT with ALC ON as follows:

[LF] [Mod Drive]
 [SIG GEN] [FM] 90 kHz [Select Source]
 [Select External] [Ext1 ALC Coupling] [SIG GEN]

- (4) Set the digital multimeter to read dB and measure and record this value.

- (5) Set the function generator to the frequencies given in Table 5-1-9 and measure the LF output relative to that reading taken in (4) above. The difference should be less than 1 dB.
- (6) Set the function generator to give 0.7 V output and repeat (4) and (5) above.
- (7) Set the function generator to give 1.4 V output and repeat (4) and (5) above.

Mod input 2

- (8) Connect the test equipment as in Fig. 5-1-7 except with the function generator output connected to EXT MOD 2 INPUT on the UUT.
- (9) Set the UUT to EXT MOD 2 INPUT with ALC ON as follows:

[Select source] [Ext2 ALC Coupling] [SIG GEN]

- (10) Reset the function generator as in (2) above and repeat (4) to (7) above.

TABLE 5-1-9 EXTERNAL MODULATION FREQUENCIES

External modulation frequencies			
10 Hz	50 Hz	20 kHz	200 kHz
20 Hz	1 kHz ref	100 kHz	500 kHz

Modulation ALC distortion

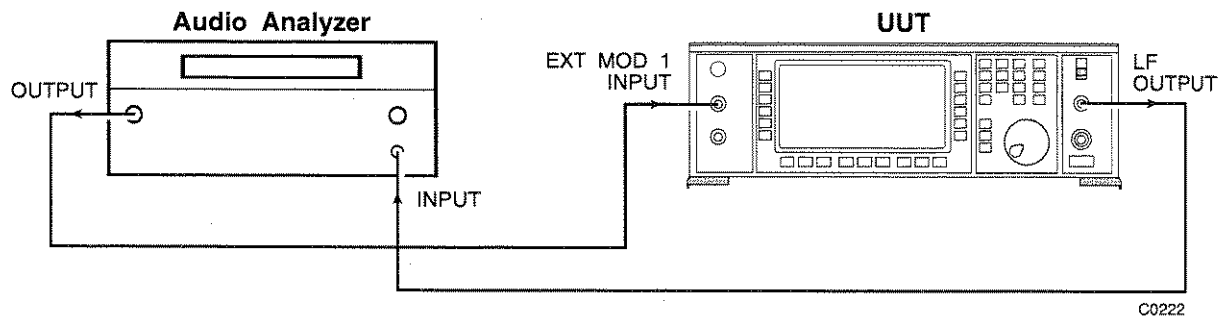

Fig. 5-1-8 Modulation ALC distortion test set-up

- (1) Connect the test equipment as shown in Fig. 5-1-8.
- (2) Set the UUT as in 'Mod input 1' (3) above.
- (3) Set the audio analyzer to give 1 V RMS output and monitor distortion.
- (4) Set the audio analyzer to 50 Hz, 1 kHz and 20 kHz measuring the distortion at each frequency which must be less than 0.1%.
- (5) Connect the test equipment as in Fig. 5-1-8 except with the output from the audio analyzer connected to EXT MOD 2 INPUT on the UUT and set the UUT as in 'Mod input 2' (9) above.
- (6) Repeat (4) above.

INTERNAL AM DEPTH AND DISTORTION

SPECIFICATION	
Range:	0 to 99% in 0.1% steps.
Accuracy:	For carrier frequencies up to 1 GHz, $\pm 4\%$ of setting $\pm 1\%$ depth. Usable to 1.35 GHz (2050), 2.7 GHz (2051), 5.4 GHz (2052).
Envelope distortion:	Less than 3% THD for AM depths up to 80% at 1 kHz modulation frequency. Less than 1% THD for AM depths up to 30% at 1 kHz modulation frequency.
Phase mod on AM:	Typically less than 0.1 rad at 30% depth on a 500 MHz carrier.

TEST EQUIPMENT		
Description	Minimum specification	Example
Modulation meter	1.5 MHz to 1 GHz. Accuracy: Better than 1.1%.	IFR 2305 + distortion option

TEST PROCEDURES

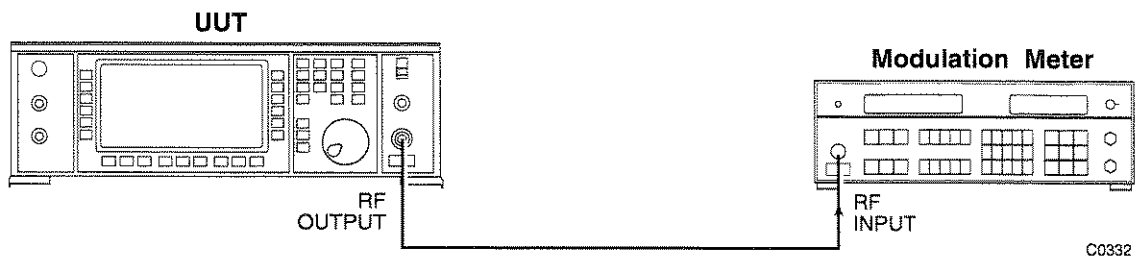

Fig. 5-1-9 Internal AM depth and distortion test set-up

- (1) Connect the test equipment as shown in Fig. 5-1-9.
- (2) Set the UUT to [RF Level] 0 dBm [Carrier Freq.] 1.5 MHz [AM] 30%.
- (3) Measure the AM depth and the envelope distortion on the modulation meter using the 50 Hz to 15 kHz filter setting at the frequencies shown in Table 5-1-10. Check that the measured AM depth and distortion are within specification.
- (4) Set the UUT to an AM depth of 80% and repeat (3) above.
- (5) Set the UUT to [RF Level] +7 dBm (+4 dBm for instruments fitted with Option 012) and repeat (3) and (4) above.

TABLE 5-1-10 AM DEPTH AND DISTORTION FREQUENCIES

Carrier frequencies (MHz)

1.5	400
31.0	500
43.0	850
200.0	1000

AM scale shape

- (1) Connect the test equipment as shown in Fig. 5-1-9.
- (2) Set the UUT to *[RF Level]* 0 dBm *[Carrier Freq.]* 100 MHz *[AM]* 1%.
- (3) Measure the AM on the modulation meter at the depths shown in Table 5-1-11. Check that the measured depths are within specification.

TABLE 5-1-11 AM DEPTHS

AM depth (%)

1	10	31	34	37	39.1	39.4	39.7	40	70
2	20	32	35	38	39.2	39.5	39.8	50	80
5	30	33	36	39	39.3	39.6	39.9	60	85

Phase modulation on AM

- (1) With the test equipment set up as in Fig. 5-1-9, set the UUT to *[Carrier Freq.]* 500 MHz *[RF Level]* 0 dBm *[AM]* 30%.
- (2) Measure the incidental phase modulation which should be typically less than 0.1 radian.

EXTERNAL AM

SPECIFICATION	
Accuracy:	With ALC OFF the modulation is calibrated for an input level of 1.0 V PD RMS sine wave.
Bandwidth:	±1 dB, DC to 30 kHz relative to 1 kHz Typically ±1 dB DC to 50 kHz, relative to 1 kHz.

TEST EQUIPMENT		
Description	Minimum specification	Example
Modulation meter	Modulation frequencies from 30 Hz to 50 kHz.	IFR 2305
Function generator	DC to 50 kHz.	HP3325B
Power meter	Capable of measuring levels at 400 MHz.	IFR 6960B and 6912 sensor

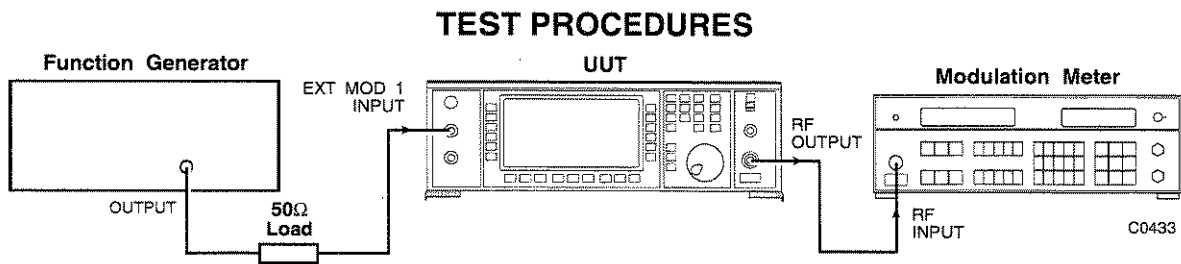

Fig. 5-1-10 External AM test set-up

- (1) Connect the test equipment as shown in Fig. 5-1-10.
- (2) Set the UUT to [RF Level] +7 dBm (+4 dBm for instruments fitted with Option 012) [Carrier Freq.] 400 MHz [AM] 80%. Then select EXT MOD 1 INPUT, DC coupled as follows:

[Select Source] [Select External] [Ext1 DC Coupling]
[SIG GEN]

- (3) Set the function generator to give 1 V RMS at 1 kHz sine wave.
- (4) With the modulation meter set to measure AM, set a reference using the relative function.
- (5) Set the function generator to the frequencies shown in Table 5-1-12 and measure the change in external AM response which should be less than 1 dB with respect to 1 kHz.

TABLE 5-1-12 EXTERNAL AM TEST FREQUENCIES

Modulation frequency		
100 Hz	1 kHz	30 kHz
300 Hz	10 kHz	50 kHz

INTERNAL FM DEVIATION

SPECIFICATION	
Range:	1 MHz max for frequencies up to 21.09375 MHz. Up to 1% of carrier frequency for carrier frequencies above 21.09375 MHz.
Resolution:	3 digits.
Accuracy:	±5% of indication ±10 Hz at 1 kHz rate internal modulation source.
Distortion:	Less than 3% at maximum deviation for modulation frequencies up to 20 kHz.

TEST EQUIPMENT		
Description	Minimum specification	Example
Modulation meter	Minimum frequency 20 MHz	IFR 2305 + distortion option

TEST PROCEDURES

- (1) Connect the test equipment as shown in Fig. 5-1-9.
- (2) Set the UUT to [*Carrier Freq.*] 21 MHz [*RF Level*] 0 dBm [*FM Devn.*] 210 kHz. Measure the FM deviation on the modulation meter.
- (3) Set up a carrier frequency step on the UUT of 1 MHz as follows:
[Δ] [*Set Steps*] [*Carrier Step*] 1 MHz [SIG GEN]
- (4) Set up an FM deviation of 500 kHz and increment the carrier frequency up to 42 MHz using the '↑' key, measuring the deviation and distortion on the modulation meter at each step. (Note that the deviation will automatically be limited to 1% of the carrier frequency for each step.) Check that the measured deviations are within specification.

FM attenuator

- (1) With the test equipment connected as in Fig. 5-1-9, set the UUT to [*Carrier Freq.*] 31.64 MHz [*RF Level*] 0dBm [*FM Devn.*] 1,260 Hz.
- (2) Measure the FM on the modulation meter at the deviations indicated in Table 5-1-13. Check that the measured deviations are within specification.

TABLE 5-1-13 FM ATTENUATOR DEVIATIONS

Deviation (kHz)		
1.26	79	224
20	159	316

FM scale shape

- (1) With the test equipment connected as in Fig. 5-1-9, set the UUT to [*Carrier Freq.*] 31.64 MHz [*RF Level*] 0 dBm [*FM Devn.*] 224 kHz.
- (2) Referring to Table 5-1-14, measure the FM on the modulation meter at the deviations indicated.

TABLE 5-1-14 FM SCALE SHAPE DEVIATIONS

Deviation (kHz)		
224	256	289
228	261	293
233	265	298
238	270	302
242	275	307
247	279	312
252	284	316

EXTERNAL FM

SPECIFICATION	
Accuracy:	With ALC OFF the modulation is calibrated for an input level of 1.0 V PD RMS sine wave.
±1 dB bandwidth:	DC to 300 kHz. Typically 500 kHz.

TEST EQUIPMENT		
Description	Minimum specification	Example
Modulation meter	Modulation frequencies from 30 Hz to 50 kHz.	IFR 2305
Function generator	DC to 300 kHz sine wave.	HP3325B
Frequency counter	Up to 40 MHz.	ETP 535B or IFR 2440

TEST PROCEDURES

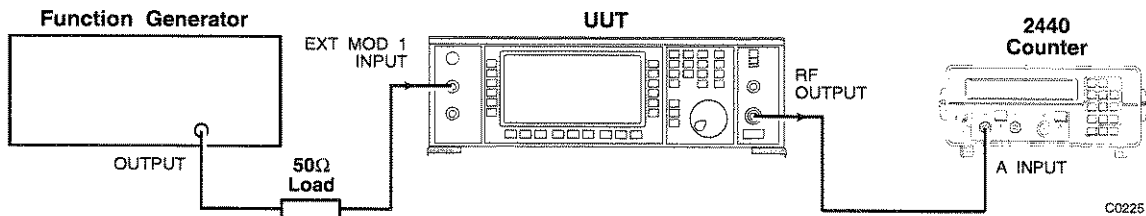

Fig. 5-1-11 External FM test set-up

- (1) Connect the test equipment as shown in Fig. 5-1-10.
- (2) Set the UUT to [Carrier Freq.] 35,468,750.1 Hz [RF Level] 0 dBm [FM Devn.] 40 kHz.

```
[UTIL] [Mod'n Mode] [Comp]
[SIG GEN] [Select Source] [Select External]
[Ext1 AC Coupling]
[SIG GEN] [FM2] [Select Source] [Ext2 AC Coupling]
[SIG GEN] 40 kHz [FM1] 40 kHz
```

The UUT will now produce FM when the external modulating source is applied to either modulation input.

- (3) Set the function generator to give 1 V RMS at 1 kHz sine wave.
- (4) With the modulation meter set to measure FM, set a reference using the relative function.

- (5) Set the function generator to the frequencies shown in Table 5-1-15 and measure the change in external FM response which should be less than 1 dB with respect to 1 kHz.
- (6) To measure the FM deviation at DC, it will be necessary to connect the test equipment as shown in Fig. 5-1-11 and DC couple the EXT MOD 1 INPUT as follows:

[Select Source] [Ext1 DC Coupling] [SIG GEN]

- (7) Using the DC offset facility on the function generator, set up a voltage of +1.4142 V (i.e. $\sqrt{2}$).
- (8) Measure and record the frequency indicated on the counter (F1).
- (9) Set the function generator to give a DC voltage of -1.4142 V.
- (10) Measure and record the frequency indicated on the counter (F2).
- (11) Calculate the FM deviation using the following formula:

$$\frac{F1-F2}{2} = \text{Measured dev} = FM1$$

- (12) It will now be necessary to reconnect the test equipment as shown in Fig. 5-1-10, reset the function generator to 1 kHz and measure the FM deviation on the modulation meter (FM2).
- (13) Using the following formula, calculate the change in response which should be less than 1 dB:

$$20 \log_{10} \frac{FM2}{FM1}$$

- (14) Transfer the function generator output to EXT MOD 2 INPUT on the UUT, select *[FM2]* and repeat (3) to (13) above.

TABLE 5-1-15 EXTERNAL FM RESPONSE FREQUENCIES

Modulating frequency (Hz)				
0	100	1,000	50,000	200,000
30	300	10,000	100,000	300,000

CARRIER FREQUENCY OFFSET

SPECIFICATION

In DC FM mode; less than $\pm(1 \text{ Hz} + 0.1\% \text{ of the set deviation})$

TEST EQUIPMENT

Description	Minimum specification	Example
Frequency counter	Up to 40 MHz.	ETP 535B or IFR 2440

TEST PROCEDURES

- (1) Connect the test equipment as shown in Fig. 5-1-3.
- (2) Short circuit the EXT MOD 1 INPUT.
- (3) Set the UUT to [*Carrier Freq.*] 1.35 GHz [*RF Level*] 0 dBm [*FM Devn.*] 13.5 MHz, then proceed as follows:
[Select Source] [Select External] [Ext1 AC Coupling] [SIG GEN]
- (4) Measure and record the carrier frequency on the counter.
- (5) Set the UUT to DC coupled EXT MOD 1 INPUT as follows:
[Select Source] [Ext1 DC Coupling] [DCFM Nulling] [SIG GEN]
- (6) Measure the change in carrier frequency (offset) which must be less than 13,501 Hz.
- (7) Change the settings of the UUT as follows:
[Select Source] [Ext2 AC Coupling] [SIG GEN]
- (8) Short circuit the EXT MOD 2 INPUT.
- (9) After a 10 second settling period, measure and record the carrier frequency on the counter.
- (10) Set the UUT to DC coupled EXT MOD 2 INPUT as follows:
[Select Source] [Ext2 DC Coupling] [DCFM Nulling] [SIG GEN]
- (11) Measure the change in carrier frequency (offset) which must be less than 13,501 Hz.

INTERNAL PHASE MODULATION

SPECIFICATION	
Range:	Up to 10 radians in 0.01 radian steps
Accuracy:	Better than $\pm 5\%$ at 1 kHz
Distortion:	Less than 3% at 1 kHz modulation rate
Bandwidth:	± 3 dB, 100 Hz to 10 kHz

TEST EQUIPMENT		
Description	Minimum specification	Example
Modulation meter	Minimum frequency 20 MHz	IFR 2305 + distortion option

TEST PROCEDURES

- (1) Connect the test equipment as shown in Fig. 5-1-9.
- (2) Set the UUT to [*Carrier Freq.*] 21,093,750.1 Hz [*RF Level*] 0 dBm [ΦM] 10 rad.
- (3) Measure the phase modulation on the modulation meter which should read 10 rad ± 0.5 rad.

Internal phase modulation flatness

- (1) Connect the test equipment as shown in Fig. 5-1-9.
- (2) Set the UUT to [*Carrier Freq.*] 21,093,750.1 Hz [*RF Level*] 0 dBm [ΦM] 10 rad [*Select Source: F4*] 1 kHz.
- (3) Set the modulation meter to measure FM with the 50 Hz - 15 kHz LF filter selected.
- (4) Measure the deviation on the modulation meter and calculate the phase modulation using the formula:

$$\Phi M = \frac{\text{FM dev (Hz)}}{\text{mod freq* (Hz)}}$$

- (5) Select the modulation source frequencies as shown in Table 5-1-16 using [*Select Source: F4*] on the UUT, then enter the frequency.
- (6) Measure the deviation on the modulation meter for each modulation frequency and calculate the phase modulation for each step using the formula in (4) above.

*No allowances need be made for the modulation frequency accuracy since it is derived from the crystal reference oscillator in the UUT.

- (7) Using the figure recorded in (4) as a reference, calculate the change in response at each modulation frequency using the formula:

$$20 \log_{10} \frac{\text{Figure recorded in (6)}}{\text{Figure recorded in (4)}}$$

The change in response should be less than 1 dB with respect to 1 kHz.

- (8) Reset the modulation frequency on the UUT to 1 kHz.
- (9) Using the modulation meter set to Φ M, select DIST and measure the distortion which must be less than 3%.

TABLE 5-1-16 MODULATION SOURCE FREQUENCIES

Modulating frequency (Hz)		
100	1,000	10,000
300	3,000	

SPECTRAL PURITY

SPECIFICATION	
For analog modulation and CW modes:	
Harmonically related signals for RF levels up to +7 dBm:	Less than -30 dBc for carrier frequencies up to 1 GHz. Less than -27 dBc for carrier frequencies up to 2.7 GHz (2051 and 2052). Less than -27 dBc for carrier frequencies up to 5.4 GHz (2052 only).
Sub-harmonics:	Less than -90 dBc for carrier frequencies up to 1.35 GHz. Less than -40 dBc for carrier frequencies up to 2.3 GHz (2051 and 2052). Less than -30 dBc for carrier frequencies up to 2.7 GHz (2051 and 2052). Less than -30 dBc for carrier frequencies up to 5.4 GHz (2052 only).
Non-harmonics:	Less than -70 dBc for carrier frequencies up to 2.7 GHz at offsets of 3 kHz or greater. Less than -64 dBc for carrier frequencies up to 5.4 GHz (2052 only).
Residual FM:	Less than 7 Hz RMS in a 0.3 to 3.4 kHz unweighted bandwidth at a 470 MHz carrier.

TEST EQUIPMENT		
Description	Minimum specification	Example
Modulation meter	Capable of measuring Residual FM less than 7 Hz	IFR 2305
Spectrum analyzer	10 kHz to 16.2 GHz frequency coverage	IFR 2386

Residual FM

TEST PROCEDURES

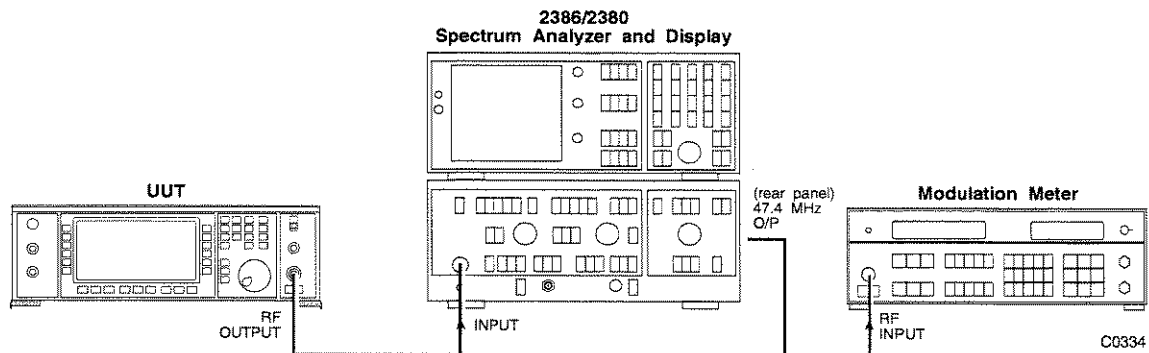

Fig. 5-1-12 Residual FM test set-up

- (1) Connect the test equipment as shown in Fig. 5-1-12.
- (2) Set the UUT to [Carrier Freq.] 470 MHz [RF Level] 0 dBm, modulation OFF.
- (3) Set the spectrum analyzer to 470 MHz zero span.
- (4) Measure the residual FM on the modulation meter in a 300 Hz to 3.4 kHz bandwidth, which must be less than 7 Hz.

Carrier harmonics

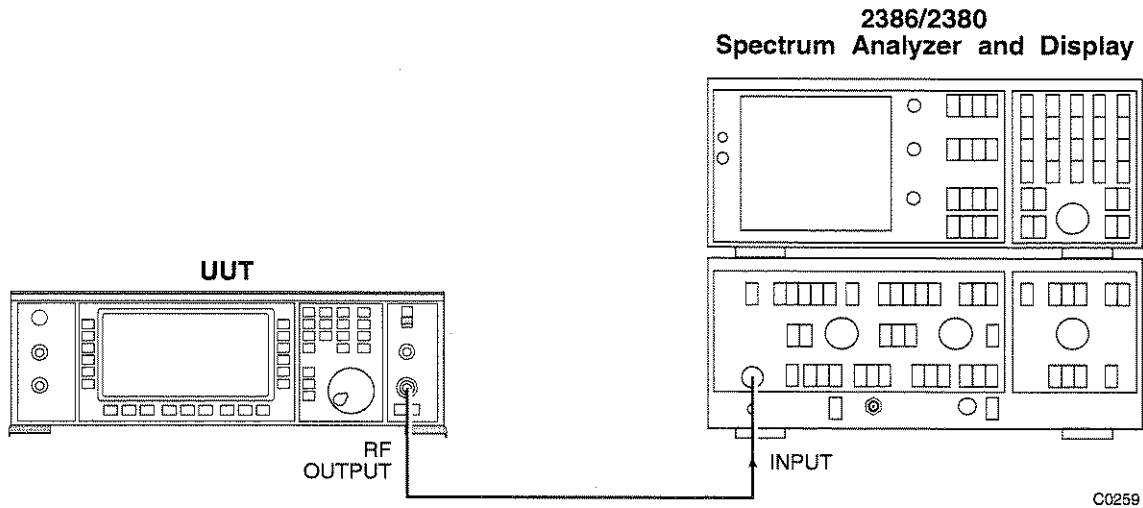

Fig. 5-1-13 Carrier harmonics test set-up

- (1) Connect the test equipment as shown in Fig. 5-1-13.
- (2) Set the UUT to [Carrier Freq.] 10 kHz [RF Level] 7 dBm.
- (3) On the spectrum analyzer measure the 2nd and 3rd harmonics of the carrier frequency which must be less than -30 dBc for carrier frequencies up to 1 GHz and less than -27 dBc for carrier frequencies above 1 GHz.
- (4) Set the UUT to the frequencies indicated in Table 5-1-17 and repeat (3) above.

TABLE 5-1-17 CARRIER HARMONIC FREQUENCIES

Carrier frequencies (Hz)			
(2050/1/2)			
10,000.0	42,187,500.1		
100,000.0	84,375,000.3	(2051/2)	(2052 only)
10,000,000.0	168,750,000.5	1,350,000,001.0	2,700,000,001.0
20,000,000.0	337,500,001.1	1,920,000,000.0	4,050,000,000.0
21,093,750.1	675,000,002.1	2,699,999,999.0	5,400,000,000.0

Carrier sub-harmonics (2051 and 2052 only)

- (1) Connect the test equipment as shown in Fig. 5-1-13.
- (2) Set the UUT to [RF Level] +13 dBm (+10 dBm for instruments fitted with Option 012) [Carrier Freq.] 1,350,100,000.0 Hz.
- (3) Referring to Table 5-1-18, measure the level of the sub-harmonics on the spectrum analyzer at the frequencies indicated. Check that the levels are within specification.

TABLE 5-1-18 CARRIER SUB-HARMONIC FREQUENCIES

UUT carrier	Spectrum analyzer frequency (Hz)	
(2051/2)		
1,350,100,000.0	675,050,000.0	2,025,150,000.0
1,500,000,000.0	750,000,000.0	2,250,000,000.0
2,000,000,000.0	1,000,000,000.0	3,000,000,000.0
2,299,999,990.0	1,149,999,995.0	3,449,999,985.0
2,300,000,010.0	1,150,000,005.0	3,450,000,015.0
2,649,000,000.0	1,324,500,000.0	3,973,500,000.0
2,700,000,000.0	1,350,000,000.0	4,050,000,000.0
	$\frac{fc}{4}$ and $\frac{3fc}{4}$	$\frac{fc}{2}$ and $\frac{5fc}{4}$
(2052)		
2,701,000,000.0	675,250,000.0	1,350,500,000.0
	2,025,750,000.0	3,376,250,000.0
3,375,000,000.0	843,750,000.0	1,687,500,000.0
	2,531,250,000.0	4,218,750,000.0
4,050,000,000.0	1,012,500,000.0	2,025,000,000.0
	3,037,500,000.0	5,062,500,000.0
4,725,000,000.0	1,181,250,000.0	2,362,500,000.0
	3,543,750,000.0	5,906,250,000.0
5,400,000,000.0	1,350,000,000.0	2,700,000,000.0
	4,050,000,000.0	6,750,000,000.0

Non-harmonics

- (1) Connect the test equipment as shown in Fig. 5-1-13.
- (2) Set the UUT to [RF Level] 0 dBm [Carrier Freq.] 10 kHz.
- (3) Set the spectrum analyzer to a span of 100 Hz, 10 Hz filter, and referring to Table 5-1-19, measure the level of the non-harmonics at the frequencies indicated ensuring that the levels measured are less than -70 dBc.

TABLE 5-1-19 CARRIER NON-HARMONIC FREQUENCIES

UUT carrier frequency (Hz)	Spectrum analyzer frequency (Hz)
(2050/1/2)	
10,000.0	104,867,600.0
1,000,000.0	105,857,600.0
20,000,000.0	124,857,600.0
21,093,749.0	125,951,349.0
200,000,000.0	104,867,600.0
1,350,000,000.0	1,348,322,280.0 & 1,351,677,720.0
(2051/2)	
2,700,000,000.0	2,500,000,000.0
(2052)	
5,400,000,000.0	5,200,000,000.0

SSB phase noise

SPECIFICATION	
SSB phase noise :	Less than -116 dBc /Hz (typically -122 dBc/Hz) at an offset of 20 kHz from a carrier frequency
Digital mode:	Less than -108 dBc/Hz at an offset of 20 kHz.

TEST EQUIPMENT		
Description	Minimum specification	Example
Phase noise measuring device	Capable of measuring phase noise of -116 dBc	IFR L262
Signal generator	SSB phase noise at least -116 dBc at 20 kHz offset from a 470 MHz carrier signal	IFR 2040
Spectrum analyzer	Capable of measuring 100 Hz to 100 kHz	IFR 2382

TEST PROCEDURES

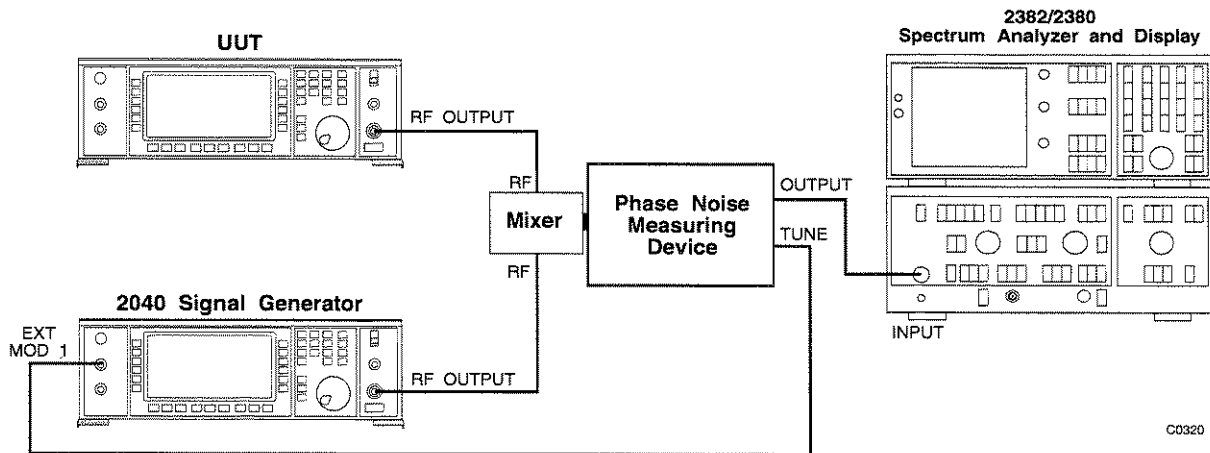

Fig. 5-1-14 SSB phase noise test set-up

- (1) Connect the test equipment as shown in Fig. 5-1-14.
- (2) Set the UUT to [Carrier Freq.] 470 MHz [RF Level] 7 dBm, modulation to OFF.
- (3) Using the phase noise measuring device, measure SSB phase noise at a 20 kHz offset which must be less than -116 dBc.
- (4) Set the UUT to provide +6 dBm in Digital Modulation Mode, Test Tones selected with the I and Q inputs set to 0 mV and DC offset set to 500 mV as follows:-

```
[RF Level] 6 dBm [UTIL][Mod'n. Mode][Digital][SIG GEN][Mod'n System]
[Select Mod. Type][Test Tones][EXIT]
[I Ampli.] 0 mV
[Q Ampli.] 0 mV
[I DC Offset] 500 mV
```

- (5) Using the phase noise measuring device, measure SSB phase noise at a 20 kHz offset, which must be less than -108 dBc.

DIGITAL MODULATION MODE

IQ outputs

Baseband IQ output signals are available on the front panel at a level of 0.5 V pk PD nominal into 50 Ω . The following test uses these outputs to provide an operational test of the drive signals for the IQ modulator in digital mode.

TEST EQUIPMENT		
Description	Minimum specification	Example
Oscilloscope	2 channel inputs with X-Y facility	Tektronix 2235

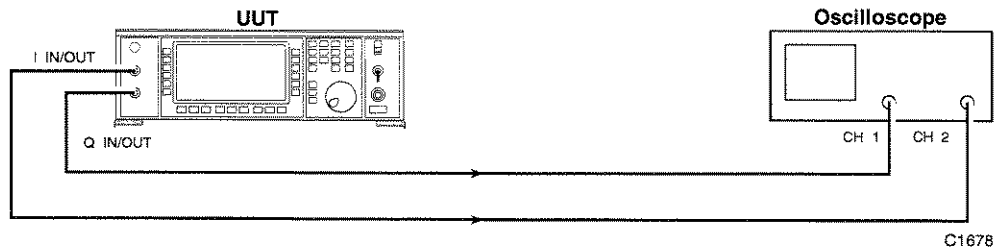

Fig. 5-1-15 IQ output test set-up

- (1) Connect the test equipment as shown in Fig. 5-1-15.
- (2) Set the UUT to Digital Modulation Mode, IQ output enabled, 8PSK modulation and a Nyquist filter as follows:-

```
[UTIL][Mod'n Mode][Digital][SIG GEN]
[Config. Select][IQ O/P Enable] [SIG GEN]
[Mod'n System][Select Mod. Type][PSK][8PSK]
[EXIT] [EXIT] [Filter Type][Nyquist][EXIT]
[SIG GEN]
```

- (3) Set the oscilloscope to X-Y, channel 1 and channel 2 sensitivities to 0.2 V/div, and check for 8 clearly defined points on the constellation as shown in Fig. 5-1-16.

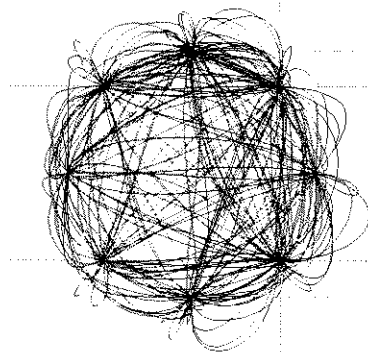

Fig. 5-1-16 8PSK constellation

- (4) Set the UUT to generate phase offset $\pi/4$ differential QPSK as follows:-

[Mod'n System][Select Mod. Type][PSK][Offset $\pi/4$ DQPSK]

- (5) Check for 8 clearly defined points on the constellation as shown in Fig. 5-1-17

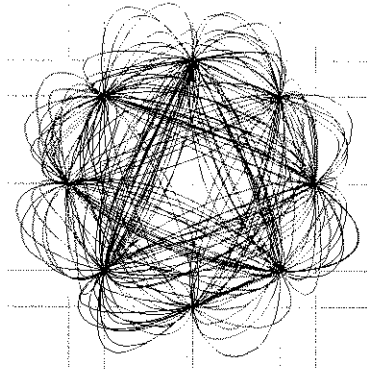

Fig. 5-1-17 $\pi/4$ DQPSK constellation

- (6) Set the UUT as follows:-

[EXIT][QAM][16 QAM]

- (7) Check for 16 clearly defined points on a 4 by 4 matrix corresponding to that shown in Fig. 5-1-18.

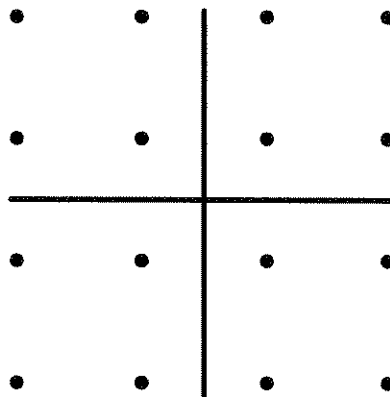

Fig. 5-1-18 16 QAM constellation

Level accuracy

Because of the presence of frequency conversion products in digital modulation mode, it is necessary to calibrate the RF levels on a spectrum analyzer. The first part of this process, steps (1) to (8), calibrates the spectrum analyzer against a power meter using CW only. Taking a photocopy of Table 5-1-20 will greatly assist when performing this procedure.

SPECIFICATION	
Level accuracy	± 1.5 dB for carrier frequencies to 2 GHz, ± 2 dB for carrier frequencies to 2.7 GHz at $23^\circ \pm 5^\circ\text{C}$. The temperature coefficient is ± 0.04 dB/ $^\circ\text{C}$

TEST EQUIPMENT		
Description	Minimum specification	Example
RF power meter	± 0.1 dB from 30 kHz to 2.7 GHz	IFR 6960B and 6912 Sensor
Spectrum analyzer	30 kHz to 2.7 GHz freq coverage	IFR 2383
Function generator	DC to 10 MHz freq coverage, ± 0.6 dB flatness	HP3325B

TEST PROCEDURES

- (1) Connect the test equipment as shown in Fig. 5-1-1.
 - (2) Set the UUT to CW mode (not digital or vector) then:
$$[RF\ Level] 0\ \text{dBm}\ [Carrier\ Freq.] 10\ \text{MHz}$$
 - (3) Measure and record the level in Table 5-1-20, column 2.
 - (4) Repeat at the frequencies listed in Table 5-1-20, column 1.
- Steps (5) to (9) which follow calibrate the spectrum analyzer.
- (5) Connect the test equipment as shown in Fig. 5-1-13.

TABLE 5-1 20 CALCULATING LEVEL ACCURACY IN DIGITAL MODULATION MODE

	1	2	3	4	5	6
	Carrier Frequency	Level measured on power meter (dBm)	Level measured on Spec. Anal. (dBm)	Difference (dB)	Level recorded on Spec. Anal. with UUT in digital mode (dBm)	Result (dBm)
	Example	-0.17	-0.24	+0.07	-0.38	-0.31
RF level 0 dBm	10 MHz 850 MHz 1750 MHz 2000 MHz 2700 MHz					
RF level +6 dBm	10 MHz 850 MHz 1750 MHz 2000 MHz 2700 MHz					

- (6) Reset the UUT to [Carrier Freq.] 10 MHz and set the spectrum analyzer as follows:-

Reference frequency	10 MHz
Reference level	10 dBm
Span/div	1 kHz

- (7) Using the peak find facility on the spectrum analyzer, record the level at each of the frequencies. Record this figure in Table 5-1-20, column 3.
- (8) Subtract the figures recorded in step (7) above from the figures recorded in step (5) and record this difference in Table 5-1-20, column 4.

Steps (9) to (15) which follow correlate the RF level accuracy in digital mode to the RF level accuracy in vector mode.

- (9) Enable an IQ self cal as follows:-

[UTIL]/[Mod'n Mode]/[Vector][SIG GEN]/[Carrier Freq.] 10 MHz [IQ Selfcal]

- (10) Connect the test equipment as shown in Fig. 5-1-19.

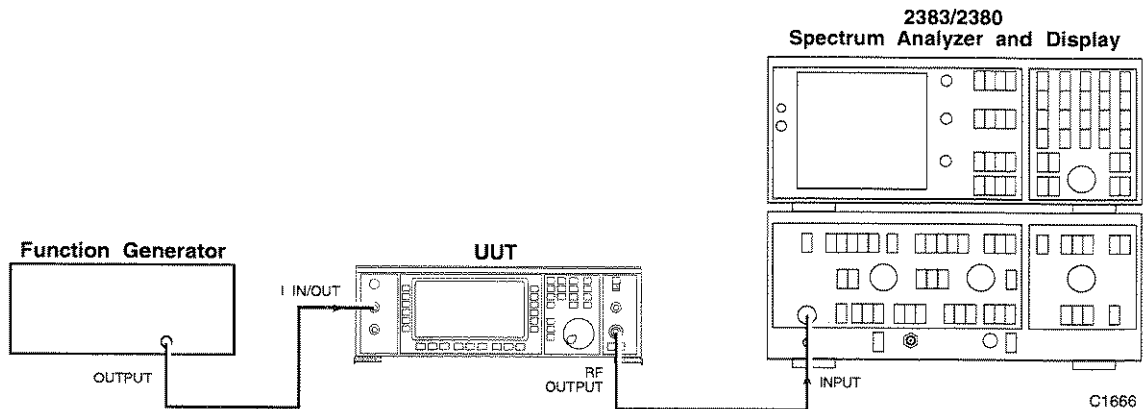

Fig. 5-1-19 Level accuracy test set-up

- (11) Set the function generator to give 0.5 V DC (into 50 Ω).
- (12) Record the level measured on the spectrum analyzer.
- (13) Disconnect the DC voltage from the I IN/OUT socket of the UUT.
- (14) Set the UUT to Digital Modulation Mode with Test Tones selected and the I, Q amplitude set to 0 mV and DC offset to 500 mV as follows:-

```
[UTIL][Digital][SIG GEN][Mod'n System][Select Mod. Type][Test
Tones][EXIT]
[I Ampli.] 0 mV
[Q Ampli.] 0 mV
[I DC Offset] 500 mV
```

- (15) Measure the level of the signal on the spectrum analyzer and compare this figure with that recorded in step (12) above. The difference must not be greater than 0.1 dB.

Having correlated the RF level accuracies in both digital and vector modes, the remainder of the RF level accuracy test is performed in digital mode only.

- (16) Set the UUT to [SIG GEN] and record the RF level values on the spectrum analyzer at each of the frequencies given in Table 5-1-20. Record these figures in column 5.
- (17) Add the figures recorded in column 5 with the difference figures recorded in column 4, and record the result in column 6.
- (18) Check the results ensuring that there are no errors greater than ± 1.5 dB at carrier frequencies up to 2 GHz, or greater than ± 2.0 dB at carrier frequencies up to 2.7 GHz (2051 and 2052 only).
- (19) Repeat steps (1) to (18) at an RF level of +6 dBm, resetting the UUT where necessary.

Modulation accuracy

SPECIFICATION

At the decision points with the envelope input at 1 V or disabled:
< 1.5% for PSK systems
< 1.5% for QAM systems
< 1.0% for NADC, PDC (EIA & RCR 27A methods)

TEST EQUIPMENT

Description	Minimum specification	Example
Spectrum analyzer	30 kHz to 2.7 GHz freq coverage	IFR 2383
DVM	AC volts measurement to 25 kHz	Datron 1061A

The RMS vector error is measured using DSP-generated test tones and calculated from the RSS of the following five errors:

1. Carrier leak
2. Signal compression
3. I/Q channel balance
4. Channel frequency response errors
5. DSP coding errors ($\pm 0.3\%$)

Establishing carrier leak

- (1) Connect the test equipment as shown in Fig. 5-1-13.
- (2) Set the UUT to a carrier of 11 MHz, an RF level of 0 dBm, in Digital Modulation Mode with Test Tones selected and the IQ angle set to 270° as follows:-

```
[Carrier Freq.] 11 MHz [RF Level] 0 dBm [UTIL][Mod'n Mode][Digital]
[SIG GEN]
[IQ Selfcal][Mod'n System][Select Mod. Type][Test Tones][EXIT]
[IQ Angle] 270 [enter]
```

- (3) Set the spectrum analyzer as follows:-

Reference frequency	11 MHz
Reference level	10 dBm
Span/div	5 kHz
Video averaging	4 sweeps

- (4) Using the markers 1 and 2 facility on the spectrum analyzer, measure the amplitude of the carrier leak relative to the upper sideband (see Fig. 5-1-20).

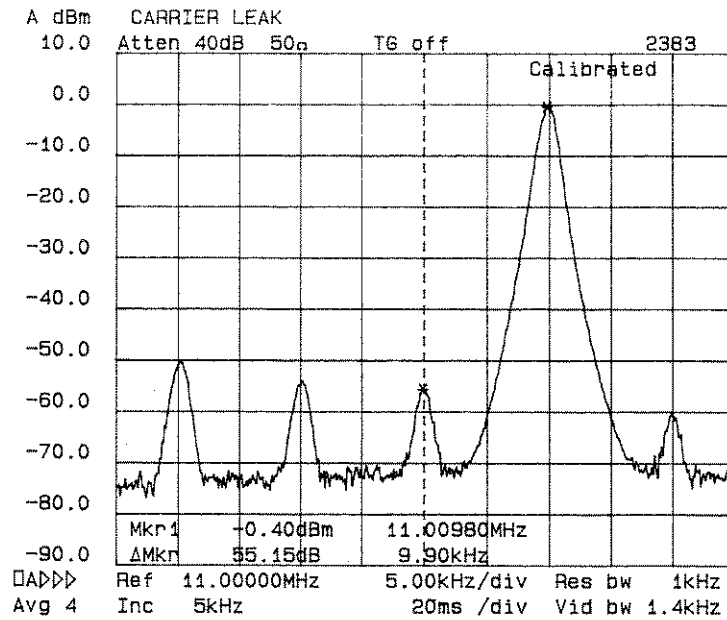

B4282

Fig. 5-1-20 Spectrum analyzer trace for carrier leak measurement

Carrier leak = _____ dBc (A)

Establishing signal compression

- (5) Set the UUT as follows:

[Q Ampli.] 0 mV [IQ Angle] 0 [enter]

- (6) Set the spectrum analyzer as follows:-

Span/div 10 kHz

- (7) Using the markers 1 and 2 facility on the spectrum analyzer, measure the amplitude of the 3rd order intermodulation products relative to the tone amplitudes. Take the worst case figure. See Fig. 5-1-21.

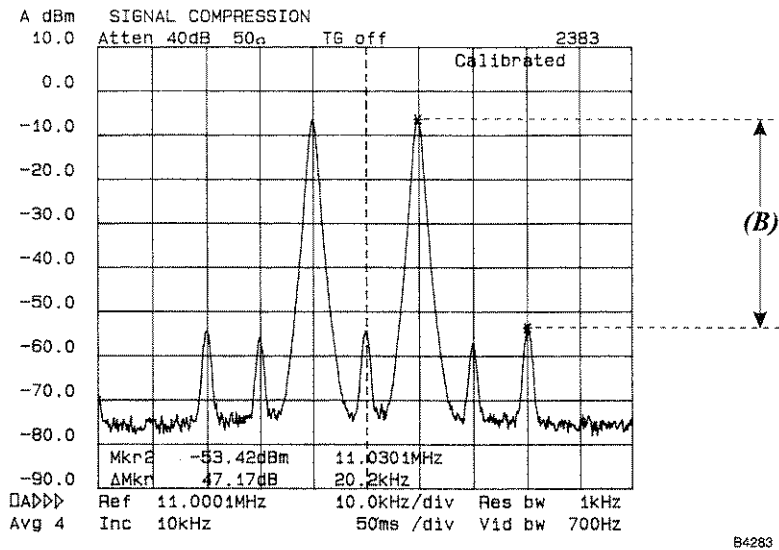

Fig. 5-1-21 Spectrum analyzer trace for signal compression measurement

Signal compression = _____ dBc (B)

Establishing IQ channel balance

- (8) Set the UUT as follows:

[Q Ampli.] 500 mV [IQ Angle] 270 [enter]

- (9) Set the spectrum analyzer as follows:-

Span/div 5 kHz

- (10) Using the markers 1 and 2 facility on the spectrum analyzer, measure the amplitude of the suppressed lower sideband relative to the upper sideband. See Fig. 5-1-22.

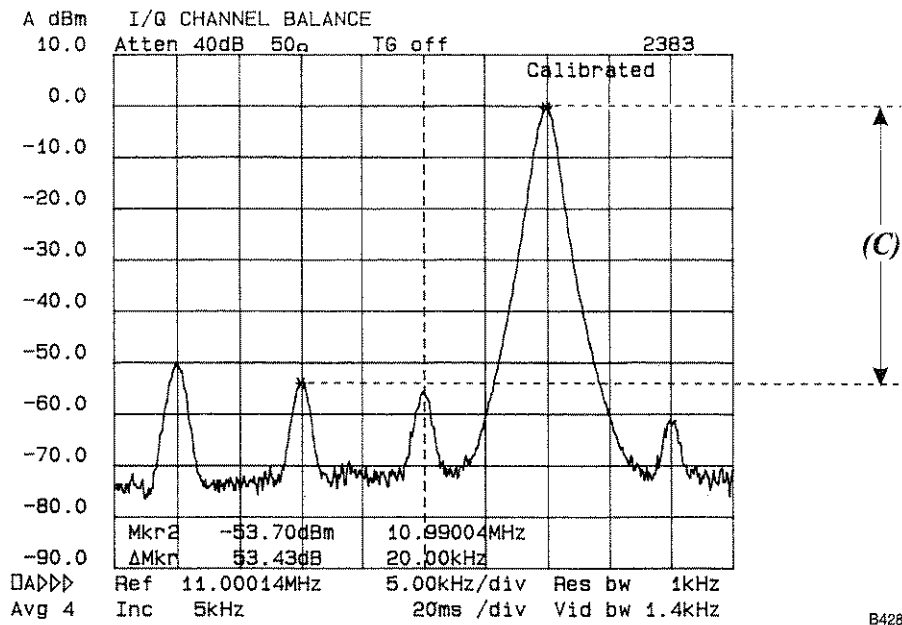

Fig. 5-1-22 Spectrum analyzer trace for IQ channel balance measurement

IQ channel balance = _____ dBc (C)

Establishing channel frequency response errors

- (11) Connect the test equipment as shown in Fig. 5-1-23.

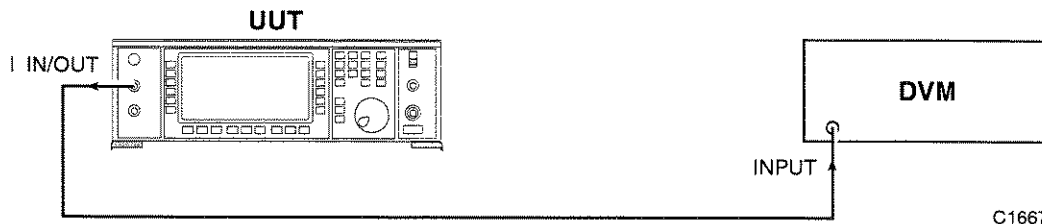

Fig. 5-1-23 Channel frequency response test set-up

- (12) Enable the UUT IQ output in Test Tone Mode with a tone frequency of 1 kHz as follows:-

[SIG GEN][Config. Select][IQ O/P Enable][SIG GEN]
[Mod'n System][Tone Freq.] 1 kHz

- (13) Set the DVM to measure AC volts and record the measured voltage:

Voltage V_1 = _____ volts

- (14) Set the UUT to [Tone Freq.] 25 kHz and record the measured voltage:

Voltage V_2 = _____ volts

- (15) Calculate the percentage error using the formula:

$$\frac{V_1 - V_2}{V_1} \times 100\%$$

- (16) Transfer the DVM to the Q output of the UUT.
(17) Repeat steps (11) to (15) above.
(18) Take the larger of the values recorded in steps (15) and (17) and record as:

Channel frequency response = _____ % (D)

- (19) Convert results A, B and C into a percentage ratio using the formula:

$$\text{percentage ratio} = \text{antilog} \left(\frac{\text{dBc}}{20} \times 100 \right)$$

(Reminder: do not forget the minus sign on the dBc figure!)

- (20) Calculate the final 'digital modulation mode accuracy' vector error figure. The vector error is the RSS of A, B, C and D and 0.3% DSP coding error. Hence the result is:

$$\% \text{ vector error} = \sqrt{A^2 + B^2 + C^2 + D^2 + 0.3^2}$$

where A, B and C are percentages

- (21) Set the UUT to [SIG GEN][ConFig. Select].
(22) Select an IF of 176 MHz using [IF Freq. Select].
(23) Repeat steps (1) to (20) above.
(24) Repeat steps (1) to (23) above at a carrier frequency of 850 MHz, and 1750 MHz and 2700 MHz for 2051 and 2052.

Burst control

SPECIFICATION	
On/off ratio:	Greater than 70 dB

TEST EQUIPMENT		
Description	Minimum specification	Example
Spectrum analyzer	80 dB dynamic range at 100 MHz	IFR 2383
Break-out box		IFR 44991-144

- (1) Connect the test equipment as shown in Fig. 5-1-24.

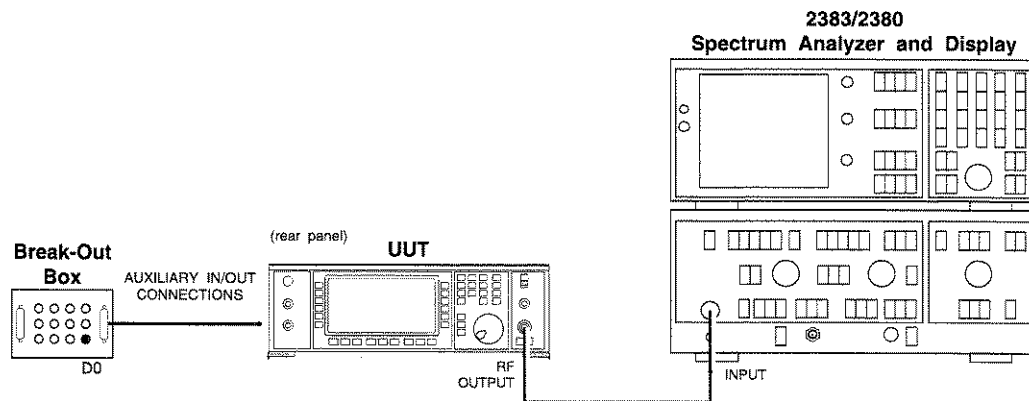

C4024

Fig. 5-1-24 Burst control test set-up

- (2) Set the UUT to 100 MHz in Digital Modulation Mode generating QPSK from external parallel data as follows:

[Carrier Freq.] 100 MHz [RF Level] 0 dBm [UTIL]/[Mod'n Mode][Digital]
 [SIG GEN]
 [Mod'n System][Select Mod. Type][PSK][QPSK(4PSK)][SIG GEN]
 [Data/Timing][External Parallel]

- (3) Set the spectrum analyzer as follows:-

Reference frequency	100 MHz
Reference level	0 dBm
Span/div	1 kHz
Peak find	
MKR 1 Sets Ref Level	
2nd funct dB	

- (4) Apply a short circuit to the BURST BIT I/P socket on the break-out box. The marker reading must be better than -70 dB.

VECTOR MODULATION MODE

SPECIFICATION	
Vector input impedance	Selectable between 50 Ω and 300 Ω .
DC vector accuracy	For carrier frequencies up to 2 GHz: $\pm 1\%$ amplitude of full scale, $\pm 1^\circ$ at full scale. For carrier frequencies above 2 GHz: $\pm 1.5\%$ amplitude of full scale, $\pm 1.5^\circ$ at full scale.
Vector bandwidth	± 0.5 dB wrt DC for frequencies up to 3 MHz, ± 1 dB wrt DC for frequencies up to 10 MHz.
Carrier suppression	Typically 50 dB at 10 kHz rate.
SSB image suppression	Typically 50 dB at 10 kHz rate, typically 50 dB at 1 MHz rate, typically 45 dB at 3 MHz rate, typically 38 dB at 10 MHz rate.

TEST EQUIPMENT		
Description	Minimum specification	Example
Digital voltmeter (DVM)	Resistance measurement capability	Datron 1061A
Spectrum analyzer	30 kHz to 2.7 GHz freq coverage, 60 dB dynamic range	IFR 2383
Function generator	DC to 10 MHz sine wave, ± 0.2 dB flatness to 1 MHz, ± 0.6 dB flatness to 10 MHz.	HP3325B

Vector input impedance

- (1) Connect the test equipment as shown in Fig. 5-1-23 above.
- (2) Set the UUT as follows:

[UTIL][Mod'n Mode][Vector][SIG GEN]
- (3) With the DVM set to measure resistance, check for a reading of approximately 50 Ω .
- (4) Set the UUT IQ input impedance to 300 Ω using [Config Select][IQ I/P "Z"]
- (5) Check for a reading on the DVM of approximately 300 Ω .
- (6) Repeat steps (2) to (5) for the UUT Q input. (Ensure that the input impedance is returned to 50 Ω by using [IQ I/P "Z"].)

DC vector accuracy

The RMS vector error is calculated from the RSS of the following three errors:

1. Carrier leak*
2. Signal compression
3. Channel balance*

* These figures are copied from the 'Digital modulation mode', 'Modulation accuracy test', results derived on page 5-1-34 and 5-1-36 in steps (4) and (10) respectively.

Establishing signal compression

(1) Connect the test equipment as shown in Fig. 5-1-19.

(2) Set the UUT as follows:

*[Carrier Freq.] 11 MHz [RF Level] 0 dBm [UTIL][Mod'n Mode]
[Vector][SIG GEN][IQ Selfcal]*

(3) Set the function generator to give 0.5 V pk (into 50 Ω) at 10 kHz sine wave.

(4) Set the spectrum analyzer as follows:

Reference frequency	11 MHz
Reference level	10 dBm
Span/div	10 kHz
Video averaging	4 sweeps

(5) Referring to Fig. 5-1-21, use markers 1 and 2 on the spectrum analyzer to measure the worst case 3rd order intermodulation product relative to the tone amplitude.

Signal compression = _____ dBc (E)

(6) Convert result E into a percentage using the formula given in step (19) of the 'Digital modulation mode', 'Modulation accuracy' test.

(7) Calculate the final 'DC vector accuracy' error:

$$\% \text{ vector error} = \sqrt{A^2 + C^2 + E^2}$$

where A, C and E are percentages

A result of less than 1% will ensure that both the ±1% amplitude and ±1° specifications have been met.

(8) Set the UUT to [SIG GEN][ConFig. Select].

(9) Select an IF of 176 MHz using [IF Freq. Select].

(10) Repeat steps (2) to (7) above.

(11) Repeat steps (2) to (10) above at a carrier frequency of 850 MHz, 1750 MHz (2051/2) and 2700 MHz (2051/2). At 2700 MHz the result should be better than ±1.5% amplitude and ±1.5° phase.

Vector bandwidth

- (1) Connect the test equipment as shown in Fig. 5-1-23.
- (2) Set the UUT to 101 MHz in Vector Mode as follows:

*[Carrier Freq.] 101 MHz [RF Level] 0 dBm [UTIL]/[Mod'n Mode]
[Vector]/[SIG GEN]/[IQ Selfcal]*

- (3) Set the function generator to give 0.5 V pk (into 50 Ω) at 100 kHz sine wave.
- (4) Referring to Table 5-1-21, set the spectrum analyzer as follows:

Reference frequency	101.1 MHz
Reference level	10 dBm
Span/div	20 kHz
Peak find	

Record the marker 1 level as the reference.

TABLE 5-1-21 VECTOR BANDWIDTH SETTINGS

	Function generator	Spec an	MKR1 reading
Upper sideband	100 kHz	101.1 MHz	_____ ref
	1 MHz	102 MHz	_____ ± 0.5 dB
	3 MHz	104 MHz	_____ ± 0.5 dB
	10 MHz	111 MHz	_____ ± 1 dB
Lower sideband	100 kHz	100.9 MHz	_____ ref
	1 MHz	100 MHz	_____ ± 0.5 dB
	3 MHz	98 MHz	_____ ± 0.5 dB
	10 MHz	91 MHz	_____ ± 1 dB

- (5) Again referring to Table 5-1-21, set the function generator and the spectrum analyzer to the frequencies indicated, recording the marker 1 level on each occasion.
- (6) Compare each level against the reference for each of the sidebands, ensuring that the difference is within the given limits.

ENVELOPE CONTROL

SPECIFICATION

Applying 1 V gives the set RF level and 0 V suppresses the carrier.

Linear range	Greater than 30 dB
Linearity	Typically better than 0.5 dB at -20 dB (100 mV input)
On/off ratio	Greater than 80 dB
Envelope delay	Less than 10 μ s
Rise/fall time	Less than 20 μ s to -70 dBc

TEST EQUIPMENT

Description	Minimum specification	Example
Oscilloscope	100 MHz bandwidth	Tektronix 2235
Spectrum analyzer	80 dB dynamic range at 10 MHz	IFR 2383
Function generator	Square wave capability, DC offset facility	HP3325B

Linearity

- (1) Connect the test equipment as shown in Fig. 5-1-25.

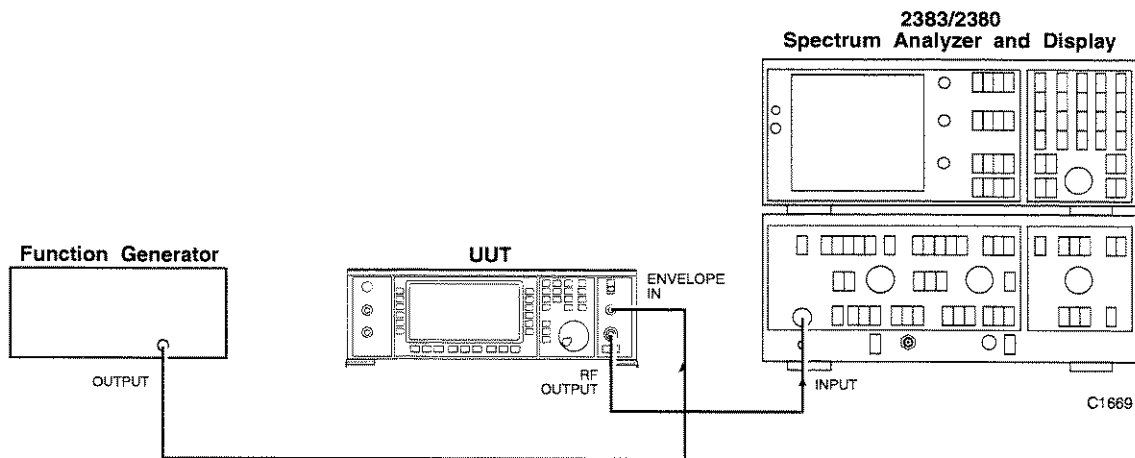

Fig. 5-1-25 Linearity test set-up

Envelope delay

- (11) Connect the test equipment shown in Fig. 5-1-26.

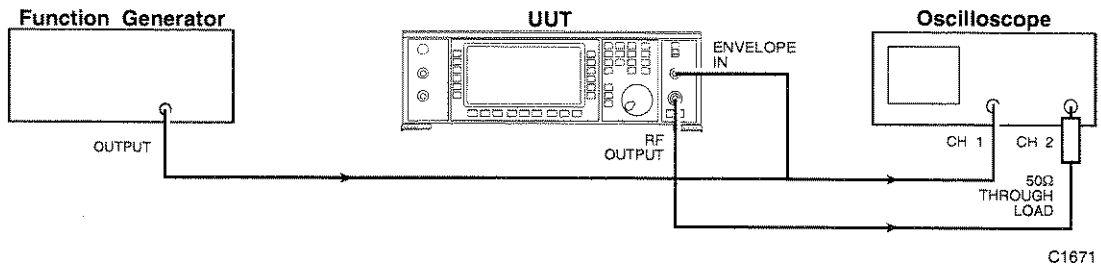

Fig. 5-1-26 Envelope delay test set-up

- (12) Set the function generator to give 1 V pk with 0.5 V DC offset (into high impedance) square wave at 10 kHz.
- (13) Set the UUT as follows:
- [SIG GEN]/Mod'n System]
 - [I Ampli.] 500 mV
 - [Q Ampli.] 500 mV
 - [I DC Offset] 0 mV
- (14) Set the oscilloscope CH1 sensitivity to 0.5 V/div, the CH2 sensitivity to 0.1 V/div, both traces, timebase 2 μ s/div.
- (15) Check that the delay from the transitions of the function generator output to the 50% point of the corresponding transitions of the UUT RF level is less than 10 μ s.
- (16) Viewing CH2 only on the oscilloscope, measure the rise and fall times (the time of the transition between 10% and 90% of the high and low RF levels) ensuring that they are less than 13.5 μ s. This includes a 6.5 μ s allowance for the difference between the 10/90% and the 0/70 dB rise-times.

IF OUTPUT

SPECIFICATION	
Output level	Nominally -10 dBm

TEST EQUIPMENT		
Description	Minimum specification	Example
Spectrum analyzer	200 MHz frequency coverage	IFR 2383

- (1) Connect the test equipment as shown in Fig. 5-1-27.

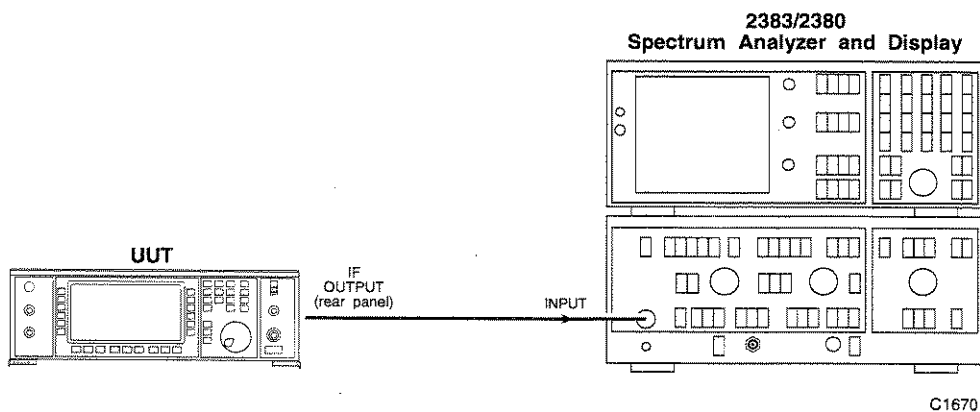

Fig. 5-1-27 IF output level test set-up

- (2) Set the UUT to Digital Modulation Mode and Test Tones selected with I and Q amplitude of 0 mV and DC offset of 500 mV. Select external mixer to enable the IF OUTPUT as follows:

```
[RF Level] 0 dBm [UTIL][Mod'n. Mode][Digital][SIG GEN]
[Mod'n System][Select Mod. Type][Test Tones][EXIT]
[I Ampli.] 0 mV
[Q Ampli.] 0 mV
[I DC Offset] 500 mV
[SIG GEN][Config. Select][Int/Ext Mixer]
```

- (3) Set the spectrum analyzer as follows:

Reference frequency	132 MHz
Reference level	0 dBm
Span/div	5 kHz

- (4) Select Peak Find on the spectrum analyzer. The marker 1 level should read nominally -10 dBm.
- (5) Set the UUT to IFs of 120, 160 and 176 MHz in turn (using *[IF Freq. Select]*), resetting the reference frequency of the spectrum analyzer accordingly, ensuring that the marker 1 level is nominally -10 dBm on each occasion.

LAST COMPLETE CHECK DATE

On completion of the adjustment routine or of a calibration check, the date can be recorded. To do this, unlock the instrument to level 2, select the Calibration Utilities Menu, then press the [*Checks Complete*] key. This will result in the *Last Complete Check* date being updated to the current date.

CALIBRATION DUE DATE

The date of the next calibration check can be entered from the calibration utilities menu by pressing the [*Set Next Cal Date*] key. On reaching the calibration date, the instrument will display an error message indicating that it should be returned for a calibration check. The recommended calibration interval is 2 years.

REAL TIME CLOCK BATTERY

The real time clock uses a lithium battery to provide uninterrupted power regardless of whether the instrument is switched on or off. Although the estimated life of this battery is 5 years, customers may wish to replace it every 2 years.

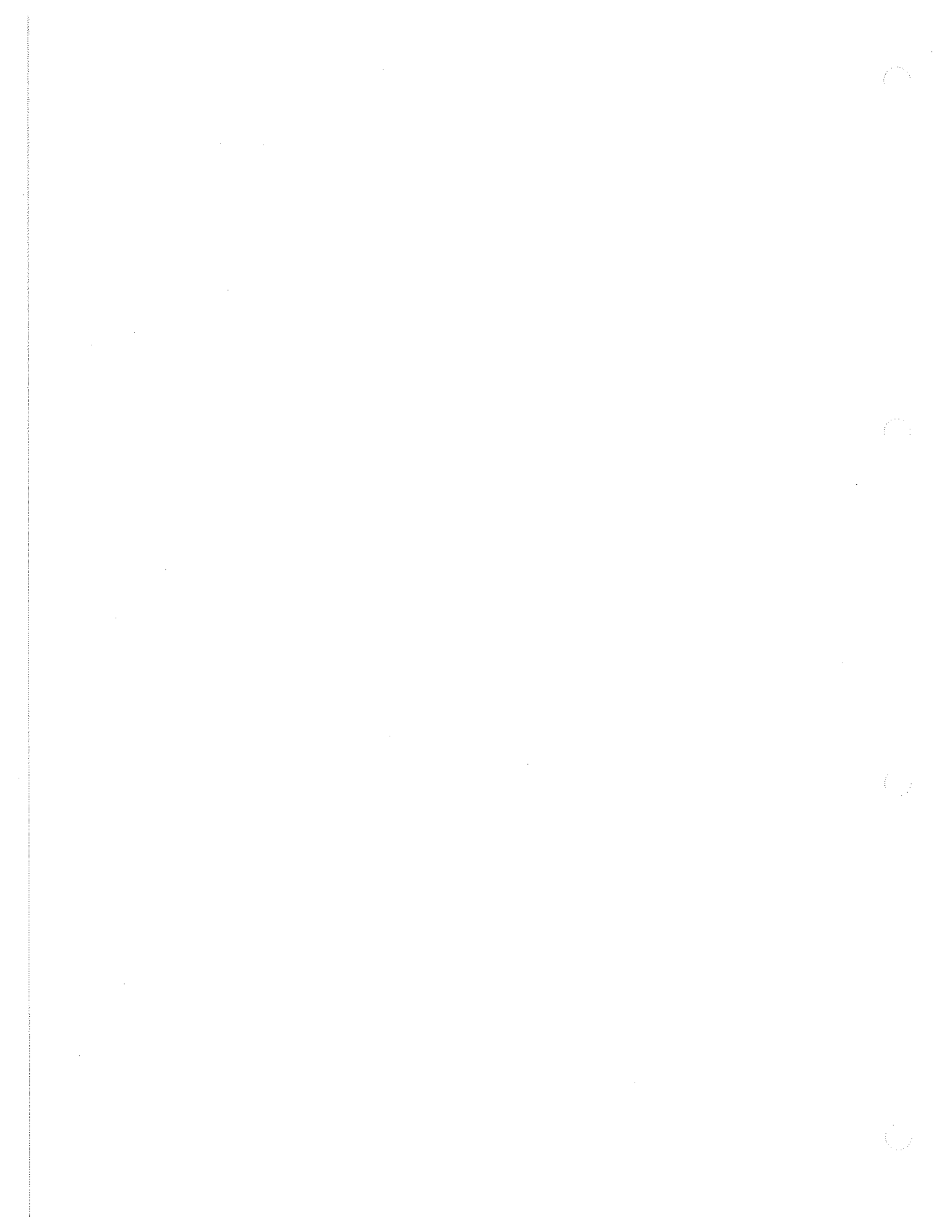

Chapter 5-1
Appendix A

ACCEPTANCE TESTING
SECOND MODULATION OSCILLATOR OPTION

CONTENTS

	PAGE
MODULATION OSCILLATORS	5-1-A-2
Modulation oscillator frequencies.....	5-1-A-2
Modulation oscillator distortion.....	5-1-A-3
LF OUTPUT	5-1-A-4
Level accuracy	5-1-A-4
Frequency response	5-1-A-5
AM SCALE SHAPE	5-1-A-6
FM SCALE SHAPE.....	5-1-A-7

LIST OF TABLES

Table 5-1-A-1 Modulation oscillator frequencies.....	5-1-A-3
Table 5-1-A-2 Distortion frequencies	5-1-A-3
Table 5-1-A-3 LF output levels	5-1-A-4
Table 5-1-A-4 Test frequencies	5-1-A-5
Table 5-1-A-5 AM depths	5-1-A-6
Table 5-1-A-6 Deviation frequencies.....	5-1-A-7

LIST OF FIGURES

Fig. 5-1-A-1 Modulation oscillator frequencies test set-up	5-1-A-2
Fig. 5-1-A-2 Modulation oscillator distortion test set-up	5-1-A-3
Fig. 5-1-A-3 Level accuracy test set-up	5-1-A-4
Fig. 5-1-A-4 LF output levels test set-up for 0.0005 V	5-1-A-4
Fig. 5-1-A-5 AM scale shape test set-up.....	5-1-A-6

MODULATION OSCILLATORS

The following tests are for a 2050, 2051 or 2052 with the 2nd modulation oscillator fitted.

SPECIFICATION	
Frequency range:	0.1 Hz to 500 kHz
Accuracy:	Equal to the frequency standard accuracy
Resolution:	0.1 Hz
Distortion:	Less than 0.1% THD at frequencies up to 20 kHz sine wave mode

TEST EQUIPMENT		
Description	Minimum specification	Example
Frequency counter	10 Hz to 500 kHz	ETP 535B or IFR 2440
Audio analyzer	Capable of measuring down to 0.03% THD from 100 Hz to 20 kHz	HP 8903B Rhode & Schwarz UPA 3

TEST PROCEDURES

Modulation oscillator frequencies

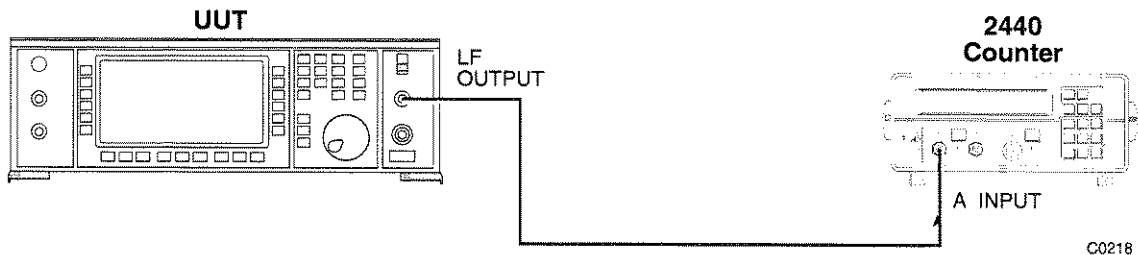

Fig. 5-1-A-1 Modulation oscillator frequencies test set-up

- (1) Connect the test equipment as shown in Fig. 5-1-A-1.
- (2) To enable both the modulation oscillators on the UUT, it will be necessary to carry out the following procedure:-

Press the following sequence of keys:

[UTIL] [Mod'n Mode] [Comp][SIG GEN] [Source Freq:]

The frequencies of the first modulation oscillator may now be entered.

- (3) Referring to Table 5-1-A-1, check that the oscillator frequencies can be selected correctly and are within specification.
- (4) To monitor the second modulation oscillator, enter the following:

*[FM2] [Select Source] [Select Internal] [Internal F1]
[LF] [Mod2 Source] [SIG GEN] [Source Freq:]*

The frequencies of the second modulation may now be entered.

- (5) Repeat (3) above.

TABLE 5-1-A-1 MODULATION OSCILLATOR FREQUENCIES

**Modulation oscillator frequencies
(Hz)**

10.00	279,620.20
139,810.10	500,000.00

Modulation oscillator distortion

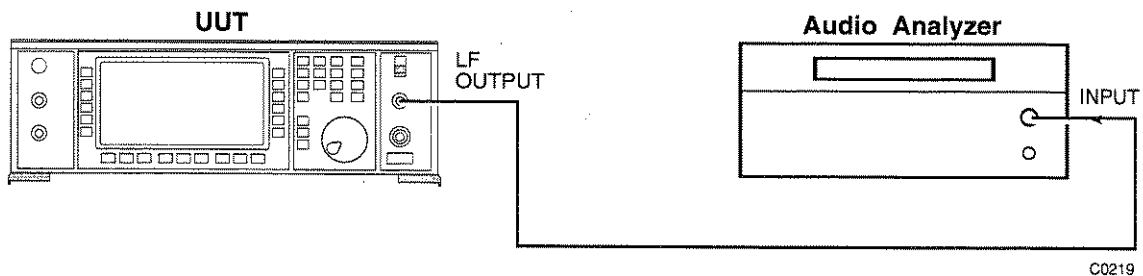

Fig. 5-1-A-2 Modulation oscillator distortion test set-up

- (1) Connect the test equipment as shown in Fig. 5-1-A-2.
- (2) Set the UUT such that the first modulation oscillator may be tested (refer to 'Modulation oscillator frequencies' step (2) above).
- (3) Check that the distortion measured on the audio analyzer at the frequencies indicated in Table 5-1-A-2 is less than 0.1%.
- (4) Set the UUT such that the second modulation oscillator may be tested (refer to 'Modulation oscillator frequencies' step (4) above).
- (5) Repeat (3) above.

TABLE 5-1-A-2 DISTORTION FREQUENCIES

Modulation oscillator frequencies

100 Hz	10 kHz
1 kHz	20 kHz

LF OUTPUT

SPECIFICATION	
Level accuracy:	$\pm 5\%$ for levels above 50 mV, $\pm 10\%$ for levels from 500 μ V to 50 mV (with a load impedance > 10 k Ω)
Frequency response:	Typically better than 1 dB from 0.1 Hz to 300 kHz

TEST EQUIPMENT		
Description	Minimum specification	Example
Digital multimeter	DC to 300 kHz, 1 mV to 5 V	Datron 1061A
Audio analyzer	Capable of measuring 0.5 mV $\pm 3\%$ and levels at 10 Hz	HP8903B Rhode & Schwarz UPA3

TEST PROCEDURES

Level accuracy

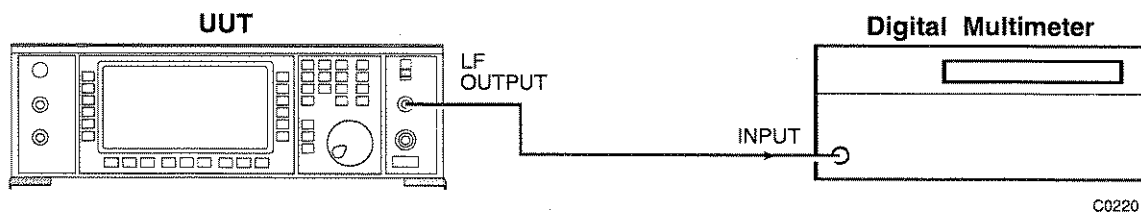

Fig. 5-1-A-3 Level accuracy test set-up

- (1) Connect the test equipment as shown in Fig. 5-1-A-3.
- (2) Set the UUT to give an LF output of 5 V at 1 kHz by entering the following:
[LF] [LF Gen] [LF Freq] 1 kHz, [LF Level] 5 V
- (3) The level measured on the digital multimeter should read 5 V ± 0.25 V.
- (4) Check the LF output of the UUT at the levels indicated in Table 5-1-A-3. Check that the measured levels are within specification.

TABLE 5-1-A-3 LF OUTPUT LEVELS

LF output levels (V)		
5.0000	0.1000	0.0050
2.0000	0.0500	0.0020
1.0000	0.0200	0.0010
0.5000	0.0100	*0.0005
0.2000		

*For the last measurement it will be necessary to use the audio analyzer. Connect the test equipment as shown in Fig. 5-1-A-4.

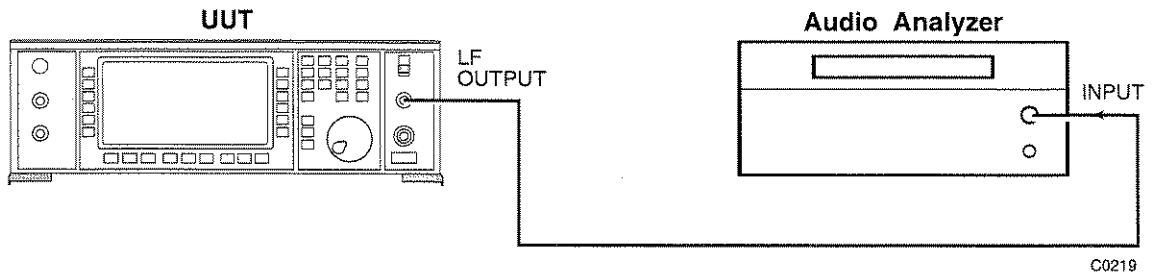

Fig. 5-1-A-4 LF output levels test set-up for 0.0005 V

Frequency response

- (1) Connect the test equipment as shown in Fig. 5-1-A-2.
- (2) Set the UUT to give an LF output of 1 V at 1 kHz on the first modulation oscillator (refer to 'Level accuracy' above).
- (3) Reference this level on the audio analyzer using the dB relative function.
- (4) Set the modulation oscillator to the frequencies given in Table 5-1-A-4 measuring the difference from the reference in (3) above which should be less than 1 dB.
- (5) Set the UUT to give an LF output of 1 V at 1 kHz on the second modulation oscillator (refer to 'Level accuracy' above).
- (6) Repeat (3) and (4) above.

TABLE 5-1-A-4 TEST FREQUENCIES

Test frequencies		
10 Hz	1 kHz ref	70 kHz
30 Hz	10 kHz	100 kHz
100 Hz	30 kHz	300 kHz

AM SCALE SHAPE

SPECIFICATION	
Range:	0 to 99% in 0.1% steps
Accuracy:	For carrier frequencies up to 1 GHz, $\pm 4\%$ of setting, $\pm 1\%$ depth. Usable to 2.7 GHz (2051). Usable to 5.4 GHz (2052).

TEST EQUIPMENT		
Description	Minimum specification	Example
Modulation meter	1.5 MHz to 1 GHz Accuracy: better than 1.1%	IFR 2305 + distortion option

TEST PROCEDURES

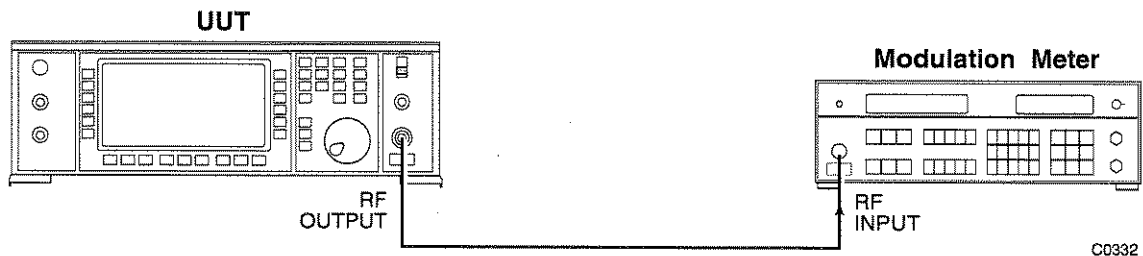

Fig. 5-1-A-5 AM scale shape test set-up

- (1) Connect the test equipment as shown in Fig. 5-1-A-5.
- (2) Set the UUT to [RF level] 0 dBm, [Carrier freq.] 100 MHz, then enter the following:

[UTIL] [Mod'n mode] [Comp]
[SIG GEN] [AM] 1%

- (3) Measure the AM on the modulation meter at the depths shown in Table 5-1-A-5. Check that the measured AM depth is within specification.
- (4) Set the UUT by entering the following:

[AM1 ON/OFF] [AM2] [Select Source] [Select internal]
[Internal F4] [SIG GEN] 1%

- (5) Repeat (3) above.

TABLE 5-1-A-5 AM DEPTHS

AM depth (%)									
1	10	31	34	37	39.1	39.4	39.7	40	70
2	20	32	35	38	39.2	39.5	39.8	50	80
5	30	33	36	39	39.3	39.6	39.9	60	85

FM SCALE SHAPE

SPECIFICATION	
Range:	1 MHz max for frequencies up to 21.09375 MHz. Up to 1% of carrier frequency for carrier frequencies above 21.09375 MHz
Resolution:	3 digits
Accuracy:	±5% of indication ±10 Hz at 1 kHz rate internal modulation source

TEST EQUIPMENT		
Description	Minimum specification	Example
Modulation meter	Minimum frequency 20 MHz	IFR 2305 + distortion option

TEST PROCEDURES

- (1) With the test equipment connected as in Fig. 5-1-A-5, set the UUT to *[Carrier freq.]* 31.64 MHz, *[RF level]* 0 dBm then enter the following:

[UTIL] *[Mod'n Mode]* *[Comp]*
[SIG GEN] *[FM2]* *[Select Source]* *[Select Internal]*
[Internal F4]
[SIG GEN] *[FM1]*

- (2) The deviation for FM1 can now be entered. Referring to Table 5-1-A-6, measure the FM on the modulation meter at the deviations indicated. Check that the measured deviation is within specification.
- (3) Set FM1 to 0 Hz deviation and select *[FM2]*.
- (4) The deviation for FM2 can now be entered. Repeat (2) above.

TABLE 5-1-A-6 DEVIATION FREQUENCIES

Deviation (kHz)		
224	256	289
228	261	293
233	265	298
238	270	302
242	275	307
247	279	312
252	284	316



Chapter 5-1
Appendix B

**ACCEPTANCE TESTING
PULSE MODULATION OPTION**

CONTENTS

	PAGE
PULSE MODULATION	5-1-B-2
Minimum 'ON' level.....	5-1-B-2
Maximum 'OFF' level.....	5-1-B-2
Additional level error	5-1-B-3
ON/OFF ratio	5-1-B-3

LIST OF TABLES

Table 5-1-B-1 ON/OFF ratio carrier frequencies.....	5-1-B-3
---	---------

LIST OF FIGURES

Fig. 5-1-B-1 Levels test set-up.....	5-1-B-2
Fig. 5-1-B-2 ON/OFF ratio test set-up	5-1-B-3

PULSE MODULATION

The following tests are for a 2050, 2051 or 2052 with the pulse modulation option fitted.

SPECIFICATION	
Maximum input level:	+5 V.
Minimum ON Level:	+3.5 V.
Maximum OFF level:	+1.0 V.
OFF/ON ratio :	Greater than 70 dB at the carrier frequency. Typically greater than 80 dB.
Additional output level error :	Less than 0.5 dB.

TEST EQUIPMENT		
Description	Minimum specification	Example
Power meter	± 0.1 dB from 30 kHz to 2.7 GHz.	IFR 6960B and 6912 sensor
Spectrum analyzer	Frequencies up to 1.4 GHz. Capable of measuring < -70 dBm.	IFR 2386
Function generator	DC capability.	HP3325B

TEST PROCEDURES

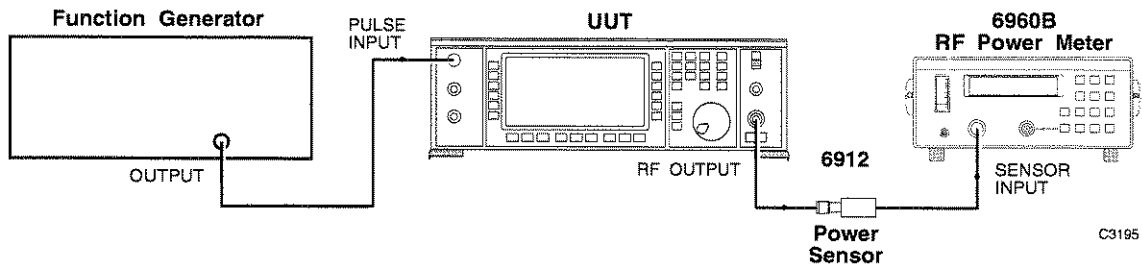

Fig. 5-1-B-1 Levels test set-up

Minimum 'ON' level

- (1) Connect the test equipment as shown in Fig. 5-1-B-1.
- (2) Set the UUT to [RF Level] 0 dBm [Carrier Freq.] 10 MHz and [Pulse Mod.].
- (3) Set the function generator to give +3.5 V DC. The 0 dBm level should now appear on the power meter.

Maximum 'OFF' level

- (4) Set the function generator to give 1.0 V DC. The 0 dBm level should now disappear from the power meter.

Additional level error

- (1) Set the UUT to [Carrier Freq.] 1 MHz, [RF level] 0 dBm.
- (2) Measure and record the RF level indicated on the power meter (P1).
- (3) Set the UUT to [Pulse Mod.]
- (4) Set the function generator to give +5 V DC.
- (5) Measure and record the RF level indicated on the power meter (P2).
- (6) The difference between P1 and P2 must be less than 0.5 dBm.

ON/OFF ratio

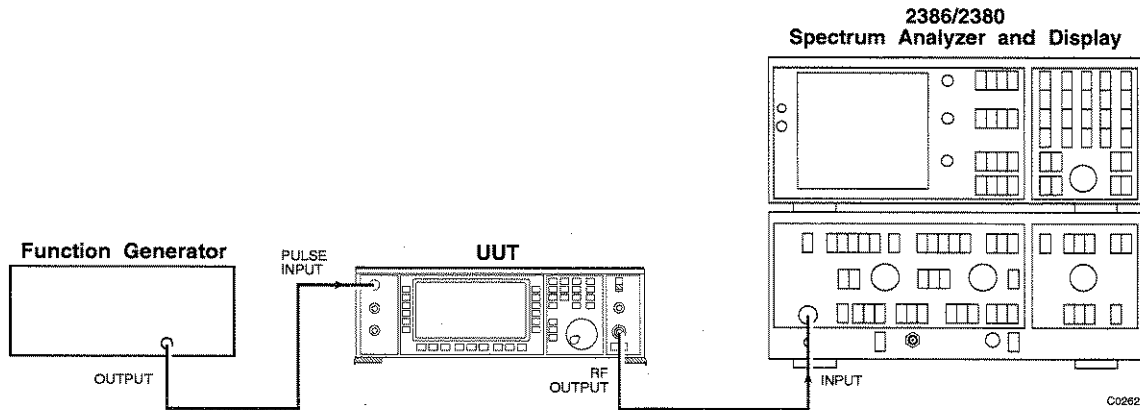

Fig. 5-1-B-2 ON/OFF ratio test set-up

- (1) Connect the test equipment as shown in Fig. 5-1-B-2.
- (2) Set the UUT to [Carrier Freq.] 11 MHz, (RF level) 0 dBm, and [Pulse Mod].
- (3) Set the function generator to give +5 VDC.
- (4) Set the spectrum analyzer to 11 MHz, span/div 10 kHz, and, using the 'Peak Find' facility, measure the amplitude of the carrier signal and record as (P1).
- (5) Set the function generator to give 0 V DC.
- (6) Measure the amplitude of the carrier signal and record as (P2). The difference between P1 and P2 must be greater than 70 dB.
- (7) Repeat (3) to (6) above for the UUT and spectrum analyzer frequencies shown in Table 5-1-B-1.

TABLE 5-1-B-1 ON/OFF RATIO CARRIER FREQUENCIES

Carrier frequencies		
11 MHz	675 MHz	1.349,999 GHz
111 MHz	1 GHz	



Chapter 5-1
Appendix C

**ACCEPTANCE TESTING
ELECTRONIC ATTENUATOR OPTION**

CONTENTS

	PAGE
TEST PROCEDURES	5-1-C-2
RF OUTPUT	5-1-C-2
ALC linearity.....	5-1-C-3
Attenuator accuracy.....	5-1-C-3
Alternative attenuator functional check.....	5-1-C-4

LIST OF TABLES

Table 5-1-C-1 Frequency settings for output levels	5-1-C-3
Table 5-1-C-2 Attenuator frequency settings	5-1-C-4

LIST OF FIGURES

Fig. 5-1-C-1 RF output flatness test set-up	5-1-C-2
Fig. 5-1-C-2 Attenuator accuracy test set-up.....	5-1-C-3

TEST PROCEDURES

Before each test, it is recommended that the UUT is reset to its switch-on conditions which are as follows:

Carrier freq	1.35 GHz (2050), 2.7 GHz (2051)
RF level	-138 dBm
FM	0 Hz ON
Single modulation mode	
Modulation	ENABLED

RF OUTPUT

SPECIFICATION	
Level range:	-127 dBm to +10 dBm (usable to -138 dBm)
Accuracy:	(2050 and 2051) ±1.2 dB from 10 kHz to 1.35 GHz at levels >-127 dBm
	(2051) ±1.2 dB from 1.35 GHz to 2.7 GHz at levels >-127 dBm

TEST EQUIPMENT		
Description	Minimum specification	Example
RF power meter	±0.1 dB from 30 kHz to 2.7 GHz	IFR 6960B and 6910 or 6912 sensor
Measuring receiver	0 dBm to -127 dBm; 2.5 MHz to 1300 MHz	HP 8902A and 11722A sensor and 11793A down converter
Signal generator	8 dBm from 32.5 MHz to 5.4 GHz	IFR 2052

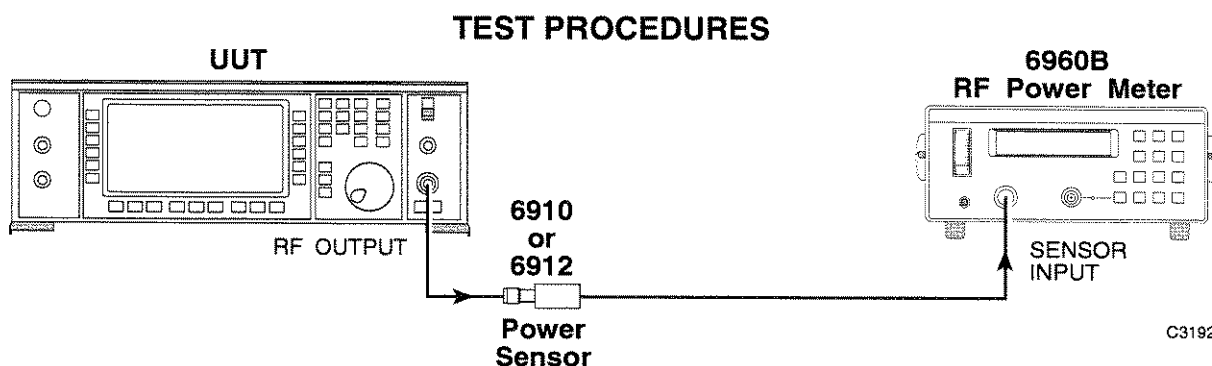

Fig. 5-1-C-1 RF output flatness test set-up

- (1) Connect the test equipment as shown in Fig. 5-1-C-1.
- (2) Set the UUT to [RF level] 0 dBm, [Carrier freq.] 250 kHz.
- (3) Check that the output level is within specification at the frequencies shown in Table 5-1-C-1.
- (4) Set the UUT RF output to 10 dBm and repeat (3) above.

TABLE 5-1-C-1 FREQUENCY SETTINGS FOR OUTPUT LEVELS

FREQUENCY (MHz)		
(2050/1)	1275	2175
0.25	1350	2325
75		2475
225	(2051)	2625
375	1351	2700
525	1425	
675	1575	
825	1725	
975	1875	
1125	2025	

ALC linearity

- (1) Connect the test equipment as shown in Fig. 5-1-C-1.
- (2) Set the UUT to [RF level] -3 dBm, [Carrier freq.] 2.5 MHz.
- (3) Increment the RF output of the UUT in 1 dB steps up to 9 dBm and in 0.1 dBm steps up to 10 dBm, measuring the RF level at each step. Check that the RF output level variation is within ± 0.1 dB.
- (4) Set the UUT carrier frequency to 500 MHz and repeat (3) above.
- (5) Set the UUT carrier frequency to 2.7 GHz and repeat (3) above.

Attenuator accuracy

The following test will confirm that the attenuator performs to the published performance specification. In the event of the receiver/down converter not being available, an alternative method to functionally test the attenuator is also suggested (see 'Alternative attenuator functional check' below).

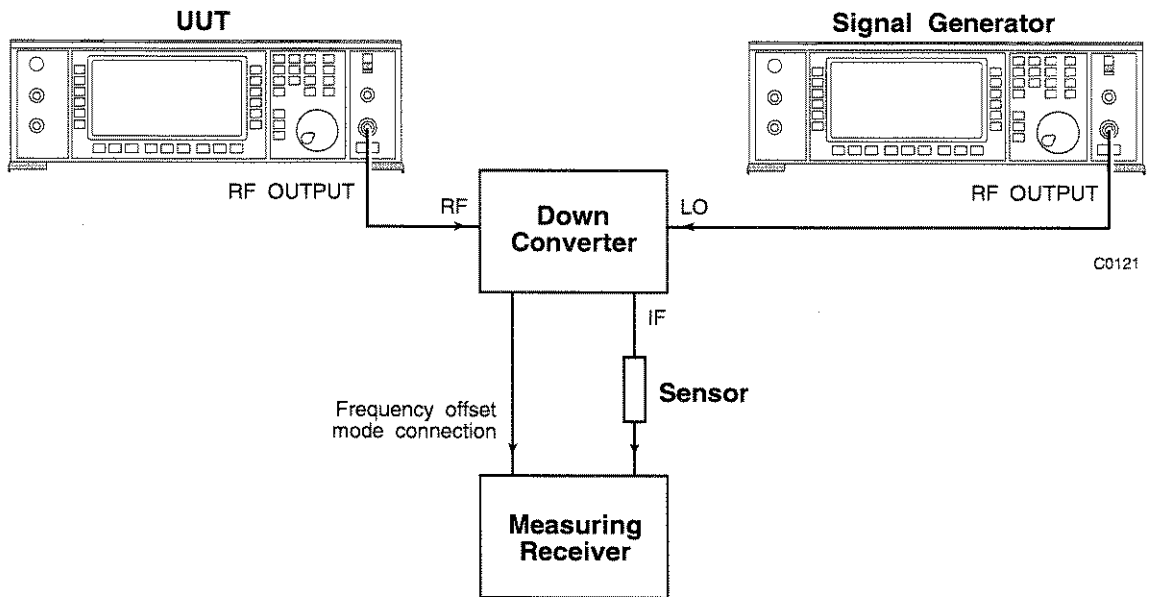

Fig. 5-1-C-2 Attenuator accuracy test set-up

- (1) Connect the test equipment as shown in Fig. 5-1-C-2.

- (2) Set the UUT to *[RF level]* 0 dBm, *[Carrier freq.]* 2.5 MHz.
- (3) Tune the receiver to 2.5 MHz and measure the RF level.
- (4) Set the UUT to *[RF level]* -6.1 dBm and measure the RF level.
- (5) Decrement the output of the UUT in 6 dB steps down to an RF level of -120.1 dBm measuring the RF level at each step. Check that the measured level is within specification.
- (6) Repeat (2) to (5) at the frequencies given in Table 5-1-C-2.
- (7) Set the local oscillator to +8 dBm at the frequencies indicated in brackets in Table 5-1-C-2.

TABLE 5-1-C-2 ATTENUATOR FREQUENCY SETTINGS

Frequency (MHz)	
2050/1	2051
2.5	1725 (1662) *
31	2700 (2637) *
325	
1125	
1275	

* At frequencies above 1300 MHz the down converter will automatically be enabled.

The frequency of the local oscillator will have to be entered on the receiver followed by the test frequency. This will automatically set the receiver to the required IF frequency.

Alternative attenuator functional check

- (1) Connect the test equipment as shown in Fig. 5-1-C-1.
- (2) Set the UUT to *[Carrier freq.]* 1.35 GHz, *[RF level]* 10 dBm.
- (3) Set a reference on the power meter.
- (4) Using the latch poke facility on the UUT, select each attenuator pad individually as follows:

[UTIL] *[Utils. Menu 2]* *[Latch Data]* 95 [enter]
[Decimal/Binary]

The binary latch data will now appear in the bottom right-hand side of the display.

- (5) By using the *[Toggle Bit]* and the *[Cursor Left]* *[Cursor Right]* soft keys, select each attenuator pad in turn which should give the nominal readings on the power meter in the following sequence:

-6 dB -30 dB -12 dB -30 dB -24 dB -30 dB

Note that no software correction is applied to the attenuator when performing this test. Therefore errors in the nominal values are not necessarily reflected in the RF level accuracy.

Annex A

OPTION 006 AVIONICS

CONTENTS

	PAGE
GENERAL DESCRIPTION	A-3
ILS mode	A-3
Marker beacon mode	A-3
VOR mode	A-3
ADF mode	A-3
SEL-CAL mode	A-3
PERFORMANCE DATA	A-4
AVIONICS OPERATION	A-6
ILS mode	A-7
DDM control	A-8
Localiser/glideslope frequency conversion	A-9
Tone suppression	A-9
Communication channel testing	A-10
Tone phase variability	A-11
Marker beacon mode	A-11
VOR mode	A-12
Sub-carrier peak deviation	A-12
Identity channel	A-14
ADF mode	A-15
SEL-CAL mode	A-16
Rotary control	A-17
GPIB OPERATION	A-18
ILS (Instrument Landing System) mode	A-19
Marker beacon mode	A-22
VOR (VHF Omnidirectional Radio Range) mode	A-23
ADF (Automatic Direction Finder) mode	A-26
Sel-cal mode	A-26
ACCEPTANCE TESTING	A-27
Introduction	A-27
Test equipment	A-27
Functional testing of ILS waveform generation	A-28
Accuracy of SDM (Sum Depth of Modulation) signal path	A-32
Accuracy of DDM (Difference Depth of Modulation) waveform	A-33
VOR waveform depth accuracy	A-35
VOR waveform test	A-36
Waveform phase control	A-37

LIST OF FIGURES

Fig. A-1 Utilities selection menu 1	A-6
Fig. A-2 Modulation mode selection menu	A-6
Fig. A-3 Avionics mode selection menu	A-7
Fig. A-4 SDM selection menu	A-7
Fig. A-5 DDM selection menu	A-8
Fig. A-6 DDM selection menu with presets	A-9
Fig. A-7 Tone suppression menu	A-10
Fig. A-8 Ident/Comms selected	A-10
Fig. A-9 ILS variable phase sub-menu	A-11
Fig. A-10 Marker beacon mode selection menu	A-12

Fig. A-11	VOR mode operation.....	A-12
Fig. A-12	VOR mode operation with peak deviation selection.....	A-13
Fig. A-13	REF selected.....	A-14
Fig. A-14	VOR mode operation with "Coupling" enabled.....	A-14
Fig. A-15	Ident/Comms selected.....	A-15
Fig. A-16	ADF mode selection menu.....	A-15
Fig. A-17	SEL-CAL mode selection menu	A-16
Fig. A-18	SEL-CAL tones utility.....	A-17
Fig. A-19	SEL-CAL tone entry	A-17
Fig. A-20	ILS functional test set-up.....	A-28
Fig. A-21	Oscilloscope trace for a 0% DDM waveform.....	A-29
Fig. A-22	Spectrum analyzer trace for a 0% DDM waveform.....	A-29
Fig. A-23	Oscilloscope trace for a 40% DDM waveform.....	A-30
Fig. A-24	Spectrum analyzer trace for a 40% DDM waveform.....	A-30
Fig. A-25	Oscilloscope trace for a 150 Hz dominant waveform.....	A-31
Fig. A-26	Spectrum analyzer trace for a 150 Hz dominant waveform.....	A-31
Fig. A-27	Accuracy of SDM signal path test set-up	A-32
Fig. A-28	Equipment configuration for DDM waveform accuracy.....	A-34
Fig. A-29	9.96 kHz sub-carrier with frequency modulation	A-36
Fig. A-30	Waveform phase control test set-up	A-37

GENERAL DESCRIPTION

This option provides internal generation of waveforms suitable for testing Instrument Landing Systems (ILS) and VHF Omnidirectional Radio Range (VOR) systems. Option 006 requires Option 001 (Second Modulation Oscillator) to be fitted.

ILS mode

In ILS mode the SDM (Sum of Depth of Modulation) of the 90 Hz and 150 Hz tones is entered to a resolution of 0.1% AM depth. The DDM (Difference in Depth of Modulation) is entered to a resolution of 0.01% depth for a DDM up to 20% and 0.1% for higher DDM settings. A choice of which tone is dominant is available to the user. DDM is also displayed in μA , to a resolution of 0.01 μA .

The 30 Hz repetition frequency of the ILS waveform can be adjusted in 0.1 Hz steps. For 0% DDM additional modulation signals can be added to the ILS waveform.

Marker beacon mode

In marker beacon mode the outer, middle and inner beacons can be tested by simple key selection.

VOR mode

In VOR mode the AM depth of the sub-carrier and 30 Hz tone can be independently set and the relative phase of the 30 Hz tone and the modulation tone on the sub-carrier is set by directly entering the bearing information in degrees. The VOR rate repetition rate of 30 Hz can be adjusted in 0.1 Hz steps. For a fixed bearing additional modulation can be applied to simulate voice/identity signal. A *[To/From]* beacon key provides a rapid means of reversing a bearing entry and accounting for different bearing conventions.

ADF mode

The ADF mode provides a simple method of testing automatic direction finding receivers operating on carriers with amplitude modulation.

SEL-CAL mode

In SEL-CAL mode the signal generator enables selective calling tones to be generated as amplitude modulation. This facility can be used to test the aircraft operator's communication system on commercial aircraft.

PERFORMANCE DATA

The following specification is in addition to that included in the 2050 series specification.

ILS MODE

Sum of Depth of Modulation (SDM)

- Range: 0 to 99.9% in 0.1% steps representing the arithmetic sum of the individual tone depths.
- Selection: By keyboard entry of data and variation by \uparrow/\downarrow keys and rotary control.
- Accuracy of SDM: $\pm 2\%$ of setting for carrier frequencies up to 400 MHz.

Difference in Depth of Modulation (DDM)

- DDM can be entered in % or as a modulation index.
- Range: 0 to 20% in 0.01% steps. 20 to 99.9% in 0.1% steps, limited by SDM.
- Selection: By keyboard entry of data and variation by \uparrow/\downarrow keys and rotary control.
- Accuracy of DDM: ± 0.0003 DDM ± 0.02 of setting.
At 0 DDM (on course) accuracy is ± 0.0003 DDM (0.03% depth);
At 0.155 DDM accuracy is ± 0.0034 DDM (0.34% depth).
- Tone frequencies: 90 Hz, 150 Hz nominal. Tone frequency may be adjusted by varying the ILS repetition rate of 30 Hz in 0.1 Hz steps. Tone frequencies maintain 3:1 and 5:1 relationships with the ILS rate.
- Tone suppression: Either tone can be suppressed.
- Additional modulation:** Available for 0% DDM from an internal or external modulation source.
- Frequency accuracy:** As frequency standard.
- LF output:** Available from the LF OUTPUT connector.
- Accuracy of DDM: $\pm 0.03\%$ ± 0.005 of setting. At 0 DDM (on course), accuracy is ± 0.0003 DDM.

MARKER BEACON MODE

Provides default modulation of 95% AM depth on a 75 MHz carrier at the modulation rate of 400 Hz (outer beacon), 1.3 kHz (middle beacon) or 3 kHz (inner beacon). AM depth, carrier frequency and modulation frequency can be changed from the default values.

VOR MODE

9.96 kHz sub-carrier

Range: 0 to 49.9% depth in 0.1% steps.
Modulation: Frequency modulated by a 30 Hz tone with 480 Hz deviation.

30 Hz tone

Range: 0 to 49.9% depth in 0.1% steps.
Arithmetic sum of 30 Hz tone and sub-carrier AM depth limited to 99.8%.

Selection: By keyboard entry of depth and variable by \uparrow/\downarrow keys and rotary control.

Bearing control: Relative phase of 30 Hz tone and sub-carrier modulation adjustable from 0° to 359.9° in 0.1° steps by entering VOR bearing. Bearing can be entered as TO or FROM the beacon.

Bearing accuracy $\pm 0.05^\circ$.

Additional modulation:

Available on 0° bearing from an internal or external modulation source.

AM depth accuracy:

$\pm 3\%$ of setting $\pm 0.5\%$ for carrier frequencies up to 400 MHz.

Frequency:

The VOR repetition frequency of 30 Hz may be varied in 0.1 Hz steps. The sub-carrier frequency and deviation maintain a fixed relationship with the VOR repetition rate

Frequency accuracy:

As frequency standard.

Audio output:

Available from the LF OUTPUT socket.

ADF MODE:

Provides default modulation of 30% AM depth on a 190 kHz carrier at 1 kHz modulation rate. AM depth, carrier frequency and modulation frequency can be changed from the default values.

SEL-CAL MODE

Data entry: Provides amplitude modulation with SEL-CAL (SElective CALLing) tones.
By soft keys labelled A to S, of up to 2 pairs of characters.

Timing: Default 1 s tone duration, 250 ms tone gap. Tone gap, duration and start delay can be changed from the default values.

AVIONICS OPERATION

This section explains how to use Option 006 when fitted to a 2050 series Signal Generator. Familiarity with the normal operation of the instrument is assumed.

The Avionics option offers modes of operation suitable for testing ILS and VOR systems. It also provides efficient testing of ADF (Automatic Direction Finders) and SEL-CAL receivers. It is assumed that the operator has some knowledge of the operation of these avionics systems.

The Avionics mode is selected by pressing the [UTIL] key and selecting the [Mod'n Mode] key on the Utilities 1 page shown in Fig. A-1 to obtain the menu shown in Fig. A-2. Selecting [Avionics Mode] from this menu will result in the Avionics Mode Selection menu shown in Fig. B-3 being displayed. Pressing the appropriate soft key will result in the instrument entering the required mode of operation; pressing [Other Modes] returns the display to the Modulation Mode Selection menu.

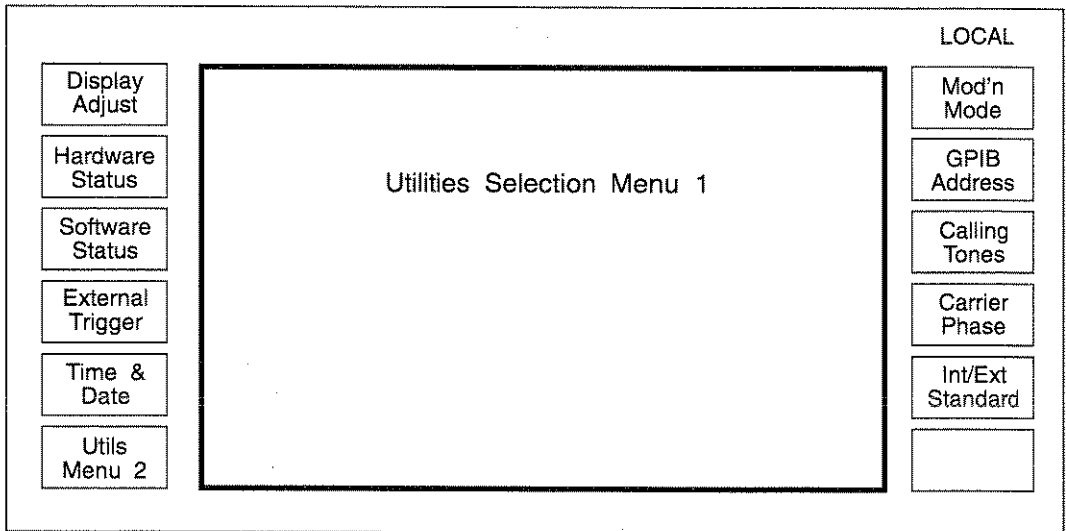

C0404

Fig. A-1 Utilities selection menu 1

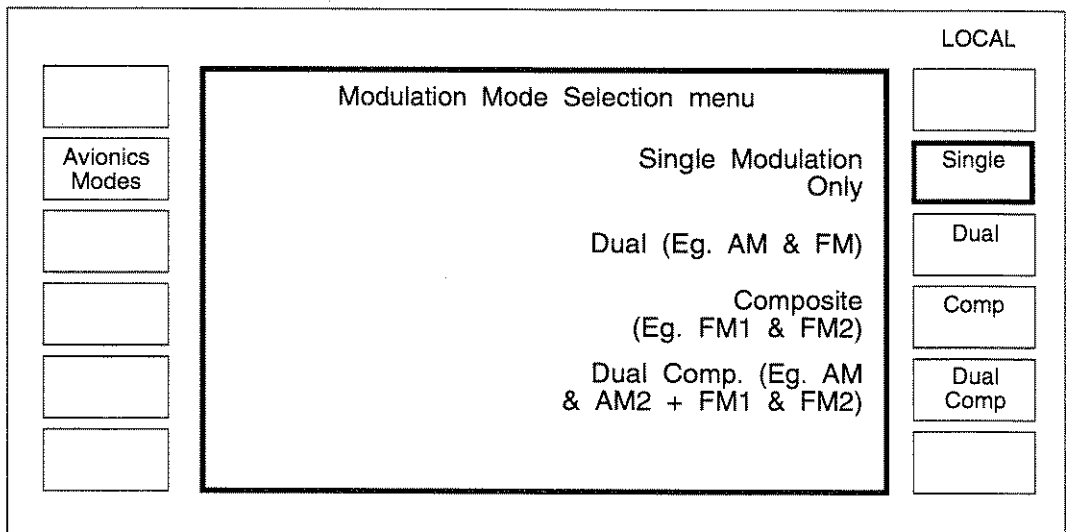

C0361

Fig. A-2 Modulation mode selection menu

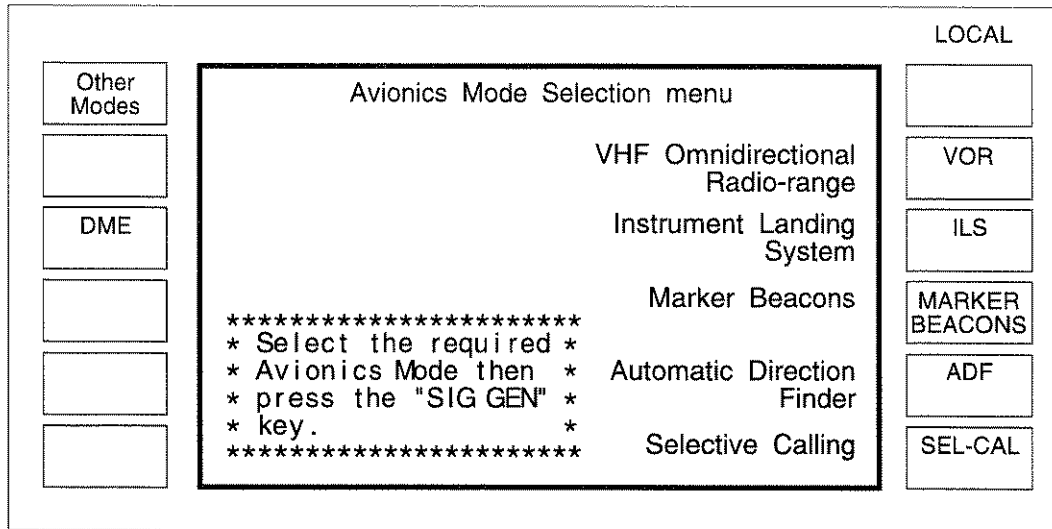

C2913

*Fig. A-3 Avionics mode selection menu
([DME] is only available if Option 010 is fitted)*

ILS mode

Pressing [ILS] and then pressing the [SIG GEN] key will result in the display shown in Fig. A-4. The default carrier frequency for ILS mode is 108.1 MHz.

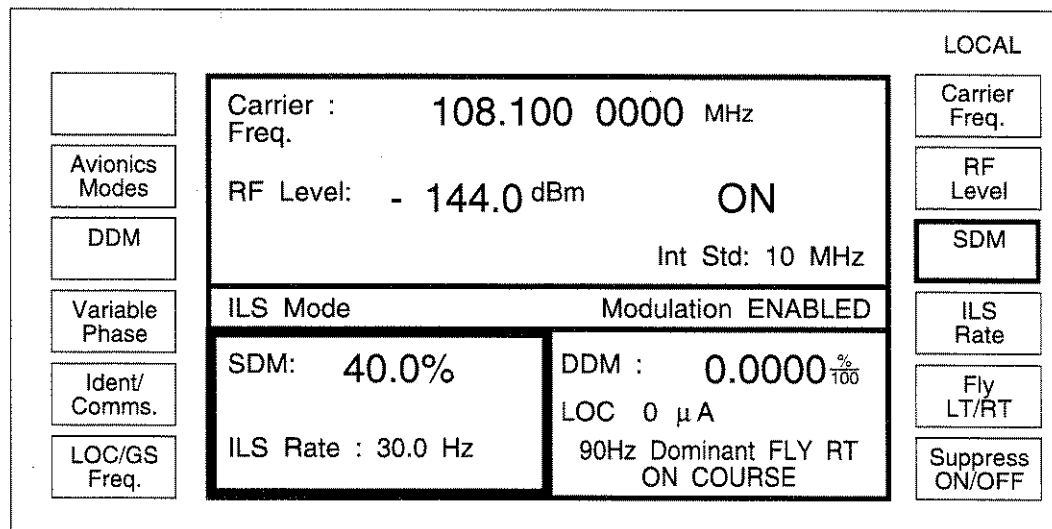

C2914

Fig. A-4 SDM selection menu

The sum of depth of modulation (SDM) is the arithmetic sum of depth of the modulating 90 Hz and 150 Hz tones. Using the [SDM] key the depth can be entered in %. The ILS rate is normally set to 30 Hz and is the ILS waveform repetition rate. Its frequency can be modified using the [ILS Rate] key. If the ILS rate is adjusted the frequency of the 90 Hz and 150 Hz alter on a pro-rata basis (e.g. If ILS Rate = 29 Hz the tone frequencies are 87 Hz and 145 Hz).

DDM control

From the SDM Selection Menu (Fig. A-4) DDM may be entered by pressing the [DDM] key to obtain the display shown in Fig. A-5.

	Carrier : 108.100 0000 MHz	LOCAL
Avionics Modes	RF Level: - 144.0 dBm ON	Carrier Freq.
SDM/ ILS Rate	Int Std: 10 MHz	RF Level
Variable Phase	ILS Mode Modulation ENABLED	DDM
Ident/ Comms	SDM: 40.0% DDM : 0.00 %	Presets ON/OFF
LOC/GS Freq.	LOC 0 μA	Fly LT/RT
	ILS Rate : 30.0 Hz 90Hz Dominant FLY RT ON COURSE	Suppress ON/OFF

C2915

Fig. A-5 DDM selection menu

The DDM can be entered in %, as a modulation index (%/100) or in microamps (μA) and displayed on the *Sig Gen* menu in %, as a modulation index, microamps or as the attenuation ratio between the 90 Hz and 150 Hz tones in dB, according to the formula:

$$R_{dB} = 20 \log_{10} \left\{ \frac{(SDM + DDM)}{(SDM - DDM)} \right\} \mu A$$

If the setting to be entered is a modulation index terminate the entry with the [enter] key. Alternatively, if the setting to be entered is in microamps terminate the entry with the [ms] key. The microamp entry is converted to the nearest 0.01%. If the carrier frequency is below 200 MHz the signal is assumed to be for a localiser and if it is above 200 MHz the signal is assumed to be for a glideslope. The following conversion factors are used:

150 μA ≡ 15.5% DDM on the localiser

150 μA ≡ 17.5% DDM on the glideslope

The units displayed can be changed without entering any data. Press the [enter] and [%] keys to toggle between modulation index and percentage. Press the [ms] and [dB] keys to toggle between microamps and attenuation ratio.

The [Fly/LT/RT] key can be used to set which tone has the greater depth of modulation and the dominant tone is displayed under the DDM set. When 90 Hz is dominant the aircraft is either to the left (localiser) or too high (glideslope). The corresponding action to be taken is displayed as *FLY RT* and *FLY DN*. Similarly when 150 Hz is dominant the aircraft is either to the right (localiser) or too low (glideslope). The corresponding action to be taken is displayed as *FL LT* and *FLY UP*. If 0% DDM is set the additional text *ON COURSE* is displayed.

DDM values can be entered using the DDM presets which provide a fast method of selecting commonly used DDM values. The DDM presets are selected using the [Presets ON/OFF] key and Fig. A-6 is produced.

DDM= 0.000	Carrier : 108.100 0000 MHz RF Level: - 144.0 dBm ON Int Std: 10 MHz ILS Mode Modulation ENABLED SDM: 40.0% DDM : 0.00 % LOC 0 μA 90Hz Dominant FLY RT ON COURSE ILS Rate : 30.0 Hz	LOCAL
DDM= 0.046		Carrier Freq.
DDM= 0.093		RF Level
DDM= 0.155		DDM
DDM= 0.200		Presets ON/OFF
LOC/GS Freq.		Fly LT/RT
		Suppress ON/OFF

C1124

Fig. A-6 DDM selection menu with presets

Five DDM preset values can be selected for either localizer or glideslope frequencies. The DDM value can still be modified by the normal numeric entry, increment or rotary controls as well as the preset mechanism. The DDM value is displayed in modulation index format when a preset value is chosen. The equivalent glideslope DDM preset keys (0.000, 0.045, 0.092, 0.175, 0.400) are displayed when a glideslope frequency is entered. The normal DDM selection menu is selected by pressing the *[Presets ON/OFF]* key.

Localiser/glideslope frequency conversion

International agreements specify that localiser and glideslope frequencies are paired on any ILS installation. The *[LOC/GS Freq.]* provides a convenient means of switching between the localiser and glideslope frequencies. Provided the carrier frequency is set near to a recognised ILS frequency, pressing *[LOC/GS Freq.]* will result in the carrier being changed to appropriate paired frequencies.

Note...

If the carrier frequency is not set precisely to the glideslope or localiser channel frequency and the *[LOC/GS Freq.]* is operated twice, the frequency will be reset to the nominal localiser/glideslope frequency.

The default SDM is 40% for localiser and 80% for glideslope, and pressing *[LOC/GS Freq.]* will automatically reset the SDM to the default value.

When changing from localiser to glideslope the *[Ident/Comms]* key will disappear and then reappear when changing back to localiser.

Tone suppression

The 90 Hz or 150 Hz tone can be suppressed when either the SDM or DDM display box is selected for data entry, using the *[Suppress ON/OFF]* key. This will result in the non-dominant tone being suppressed without altering the SDM or DDM (% or index) as shown in Fig. A-7. Selecting *[Suppress 90/150]* will change the tone to be suppressed. The modulation depth value of the active tone is displayed under the SDM setting.

		LOCAL
	Carrier : 108.100 0000 MHz	Carrier Freq.
Avionics Modes	RF Level : - 144.0 dBm ON	RF Level
SDM/ ILS Rate	Int Std: 10 MHz	DDM
Variable Phase	ILS Mode Modulation ENABLED	Presets ON/OFF
Ident/ Comms	SDM: 40.0% DDM : 0.00 %	Suppress 90/150
LOC/GS Freq.	TONE DEPTH: 20.0% LOC 0 μ A	Suppress ON/OFF
	ILS Rate : 30.0 Hz 150 Hz SUPPRESSED	

C2916

Fig. A-7 Tone suppression menu

Communication channel testing

ILS systems allow the provision of an emergency voice channel on localiser frequencies. This channel can be tested by selecting the *[Ident/Comms]* key to produce a display similar to the one shown in Fig. A-8.

		LOCAL
	Carrier : 108.100 0000 MHz	Carrier Freq.
Avionics Modes	RF Level : - 144.0 dBm ON	RF Level
SDM	Int Std: 10 MHz	AM2 Depth
DDM	ILS ZERO DDM Modulation ENABLED	Source Freq. F4
	SDM: 40.0% AM2 : 0.0% ON	AM2 ON/OFF
LOC/GS Freq.	ILS Rate : 30.0 Hz Int F4 : 1.0000 kHz	Select Source

C1126

Fig. A-8 Ident/Comms selected

In this mode a fixed 0% DDM signal is provided and an additional modulation signal can be added using the *[AM2 Depth]* key. The source of this additional modulation can be set using

the *[Select Source]* key. If internal modulation is selected the source frequency can be modified using the *[Source Freq.]* key. Selecting *[DDM]* will return the instrument to normal ILS mode.

Communication channel testing is normally only required on localiser frequencies and consequently changing from localiser to glideslope using the *[LOC/GS Freq.]* key will result in the *[Ident/Comms]* key disappearing. Additional modulation can be obtained on a glideslope frequency by directly entering the glideslope frequency instead using the numeric keys.

Tone phase variability

For normal ILS operation the phase setting between the 90 Hz and 150 Hz tones is automatically set to 0°. The *[90/150 Phase]* key can be used to adjust the phase relationship of the two tones. Selecting the *[90/150 Phase]* key produces the display shown in Fig. A-9.

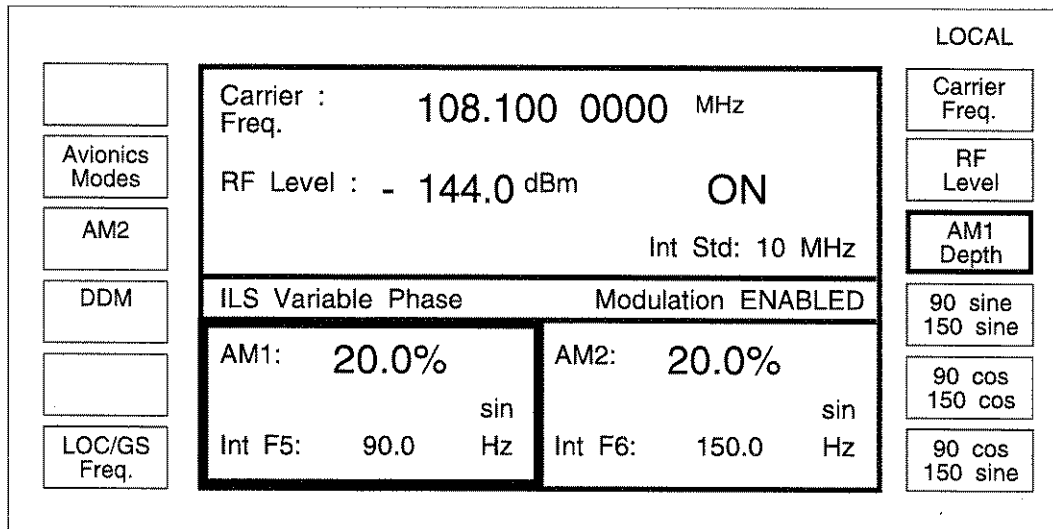

C2921

Fig. A-9 ILS variable phase sub-menu

Three phase relationships can be selected:

90 Hz sine/150 Hz sine

90 Hz cosine/150 Hz cosine

90 Hz sine/150 Hz cosine (\equiv 90 Hz cosine/150 Hz sine)

Selecting *[DDM]* will return the instrument to normal ILS mode.

Marker beacon mode

The marker beacon mode is selected using the *[MARKER BEACONS]* key on the Avionics Mode Selection menu shown in Fig. A-3. Selecting marker beacon mode and pressing the *[SIG GEN]* key produces the display shown in Fig. A-10. Initially the outer beacon is selected by default. The *[Middle Beacon]* and *[Inner Beacon]* keys change the modulation frequency to 1.3 kHz and 3 kHz respectively. Carrier frequency and AM depth can be altered, but always default to 75 MHz and 95% respectively. Modulation frequency can be changed using the *[Source Freq: F1]* key. Modulation source can be changed using the *[Select Source]* key. Pressing the *[Avionics Modes]* key returns the display to the Avionics Mode Selection menu.

	Carrier : 75.000 0000 MHz	LOCAL Carrier Freq.
Avionics Modes	RF Level : -144.0 dBm ON	RF Level
Outer Beacon	Int Std: 10 MHz	AM Depth
Middle Beacon	OUTER BEACON Modulation ENABLED	Source Freq: F1
Inner Beacon	AM : 95.0 % ON	
	Int F1 : 400.0 Hz	Select Source

C1127

Fig. A-10 Marker beacon mode selection menu

VOR mode

VOR operation can be obtained from the Avionics Mode Selection menu (Fig. A-3) or if other avionics modes have been selected, by first pressing the [Avionics Modes] key. Selecting [VOR Mode] will produce the display shown in Fig. A-11. The default carrier frequency for the VOR mode is 108 MHz.

	Carrier : 108.000 0000 MHz	LOCAL Carrier Freq.
Avionics Modes	RF Level : - 144.0 dBm ON	RF Level
REF/Bearing	Int Std: 10 MHz	SUB Depth
	VOR Mode Modulation Enabled	VOR Rate
Ident/Comms.	SUB: 30.0%	REF: 30.0%
Enable Coupling	9960Hz Subcarrier 480Hz Devn (16) VOR Rate: 30.0 Hz	Bearing To Beacon: 0.00°

C2917

Fig. A-11 VOR mode operation

Sub-carrier peak deviation

For normal VOR operation the 30 Hz reference signal, which FM modulates the 9960 Hz sub-carrier, has a peak deviation of 480 Hz (Index=16). The [Index ON/OFF] key can be used to adjust the amount of peak deviation applied. Selection the [Index ON/OFF] key produces the display shown in Fig. A-12.

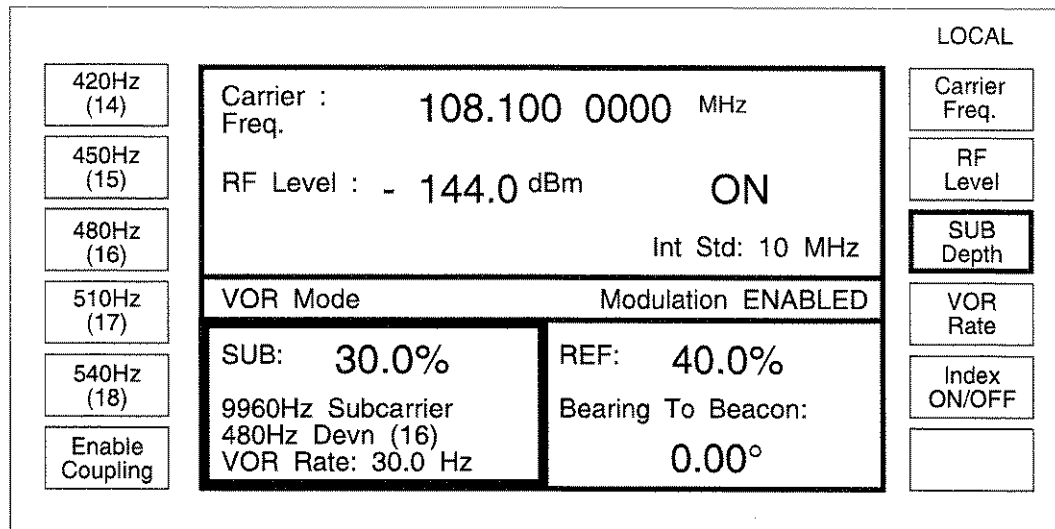

Fig. A-12 VOR mode operation with peak deviation selection

Five modulation index values (14-18) can be selected with the current selection displayed under the SUB setting. Normal VOR mode is returned by pressing the [Index ON/OFF] KEY.

Note...

The 9960 Hz sub-carrier and the peak deviation value will change in relation to the VOR rate setting.

Example: For a VOR rate of 25 Hz, the sub-carrier will be 8300 Hz and the peak deviation (for an index = 6) will be 400 Hz.

The display always reflects the sub-carrier and peak deviation settings for a VOR rate of 30 Hz.

Using the [SUB Depth] key the AM depth of the 9960 Hz sub-carrier can be entered in % and the [VOR Rate] key can be used to vary the VOR repetition rate from its normal setting of 30 Hz.

To vary the 30 Hz tone AM depth or the VOR bearing select the [REF] key to produce the display shown in Fig. A-13. The 30 Hz tone AM depth can be entered using the [REF Depth] key and bearing information can be entered in degrees using the [Bearing] key followed by the bearing data and the [enter] key. Conventions for bearing are not internationally consistent so a [To/From] key is provided to allow toggling between these two conventions. Operating this key does change the bearing but not the value displayed. It also provides a convenient way of providing a 180° bearing reversal.

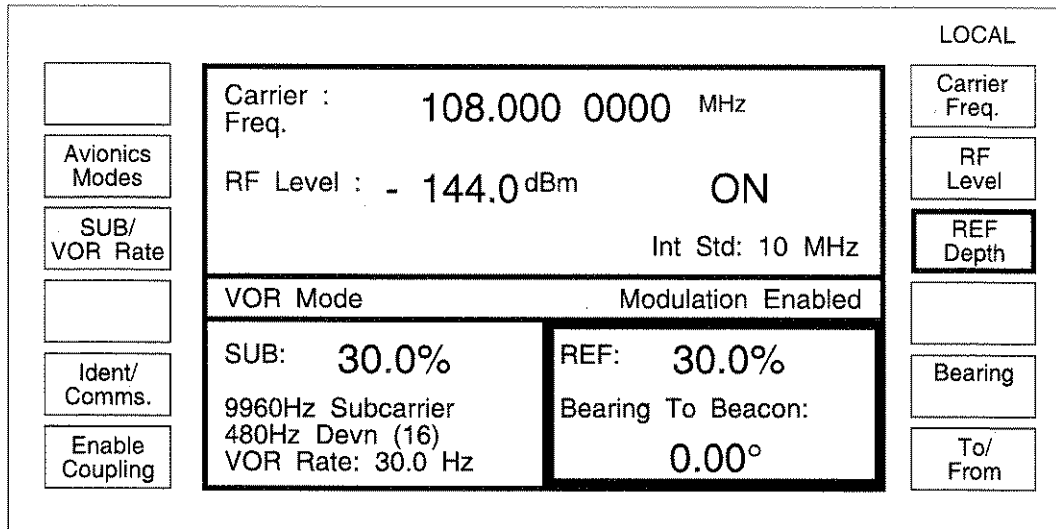

C2918

Fig. A-13 REF selected

The AM depth of the 9960 Hz sub-carrier and the 30 Hz tone can be varied simultaneously by pressing the [Enable Coupling] key which produces the display shown in Fig. A-14.

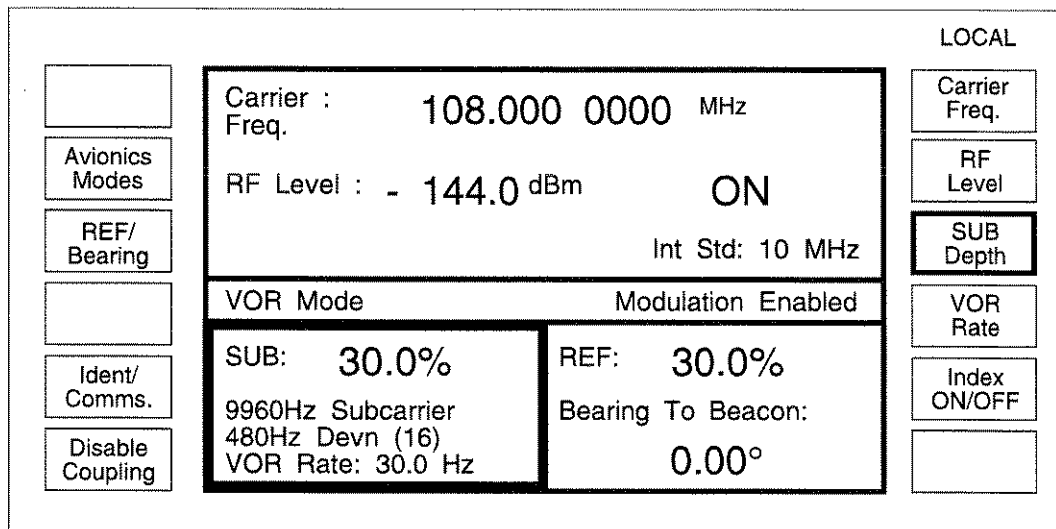

C2919

Fig. A-14 VOR made operation with "Coupling" enabled

When "coupling" is enabled, the 30 Hz AM depth is set to be equal to the 9960 Hz sub-carrier AM depth setting as the sub-carrier depth is varied. Similarly, the sub-carrier depth is set to the 30 Hz tone depth when the 30 Hz tone depth is varied. This mode of operation is disabled by pressing the [Disable Coupling] key.

Identity channel

VOR signals often carry a morse coded tone to identify the transmitter. This signal can be simulated by selecting the [Ident/Comms] key to produce a display similar to the one shown in Fig. A-15.

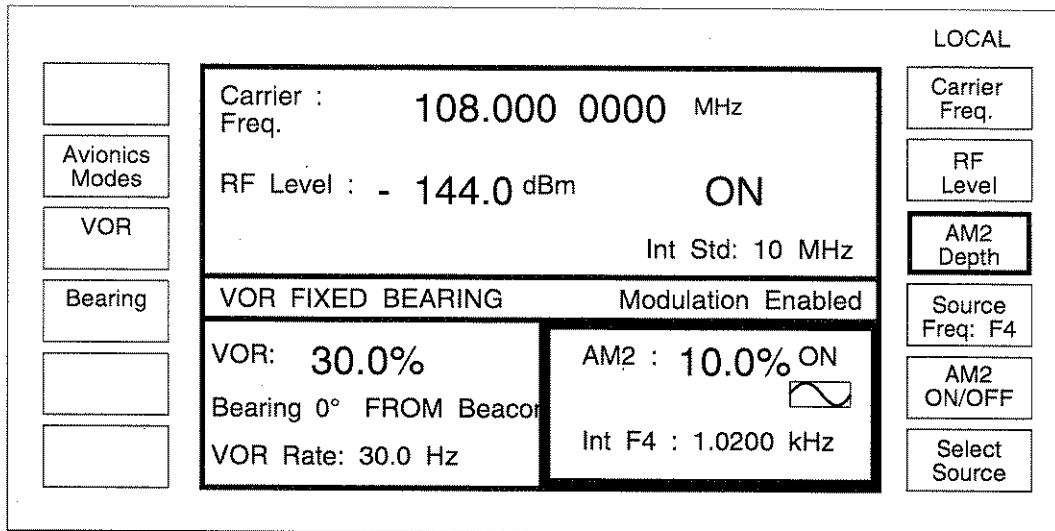

C1131

Fig. A-15 Ident/Comms selected

The instrument will generate a VOR signal having equal sub-carrier and 30 Hz tone depths with a 0° bearing. The AM depth displayed is the depth of each tone and can be changed using the [VOR] key.

An additional AM signal, AM2, can be added to this waveform. The source of this modulation can be selected using the [Select Source] key and if internal modulation has been selected the modulation frequency can be set using the [Source Freq.] key. The depth of this additional signal can be set by the [AM2 Depth] key.

ADF mode

The ADF mode is selected using the [ADF] key on the Avionics Mode Selection menu shown in Fig. A-3. This menu can be selected from other aviation modes (VOR, ILS, MARKER BEACON, SEL-CAL) using the [Avionics Modes] key. Selecting the ADF mode and pressing the [SIG GEN] key produces the display shown in Fig. A-16.

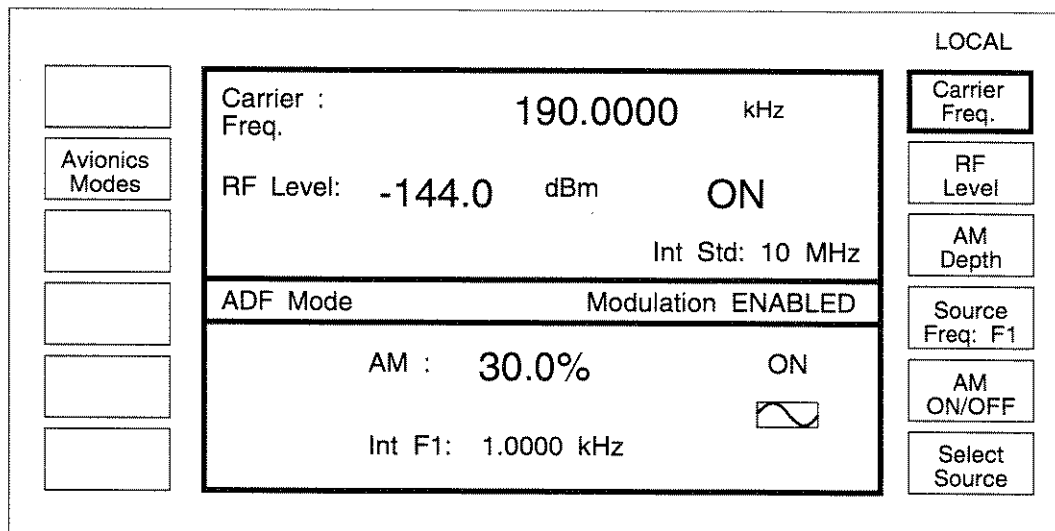

C1132

Fig. A-16 ADF mode selection menu

The carrier frequency will default to 190 kHz and the modulation depth to 30% from a 1 kHz source. This setting is used to simulate a long wave transmitter for direction finding purposes. The instrument operation is very similar to non-avionics modes with a single modulation selected (except that FM cannot be selected).

Pressing the [Avionics Modes] key returns the display to the Avionics Mode Selection Menu shown in Fig. A-3.

SEL-CAL mode

The SEL-CAL mode can be used to test receivers using AM Selective Calling Tones to the selective calling format. The mode can be selected from the Avionics Mode Selection menu shown in in Fig A-3. Selecting SEL-CAL mode and pressing the [SIG GEN] key produces the display shown in Fig. A-17.

		LOCAL
Send Tones	Carrier : 118.000 0000 MHz Freq.	Carrier Freq.
Avionics Modes	RF Level: -144.0 dBm ON Int Std: 10 MHz	RF Level
	SEL-CAL Mode Modulation ENABLED	AM Depth
SEL-CAL Code	AM : 80.0 % OFF Int F1: 1.0000 kHz	Source Freq: F1
		AM ON/OFF
		Select Source

C1133

Fig. A-17 SEL-CAL mode selection menu

The instrument operation is similar to that in non-avionics modes with a single modulation selected (except that FM cannot be selected). Carrier frequency and AM depth can be altered, but always default to 118 MHz and 80% respectively.

The SEL-CAL tones can be sent by pressing the [Send Tones] key. While the tones are being sent *Modulation ENABLED* is replaced by the message ***** SENDING TONES ***** and the normal modulation tone is suppressed.

The SEL-CAL code can be modified by pressing the [SEL-CAL Code] key to produce a display similar to the one shown in Fig. A-18. Operation of this facility is identical to that of the Sequential Calling Tones Utility in non-avionics mode. The tone duration and gap can be set but the default values are those usually used for SEL-CAL. Alternative standards can be selected using the [Select Standard] key. The [Mode Control] key can be used to change the mode from single shot but the default setting in always single shot.

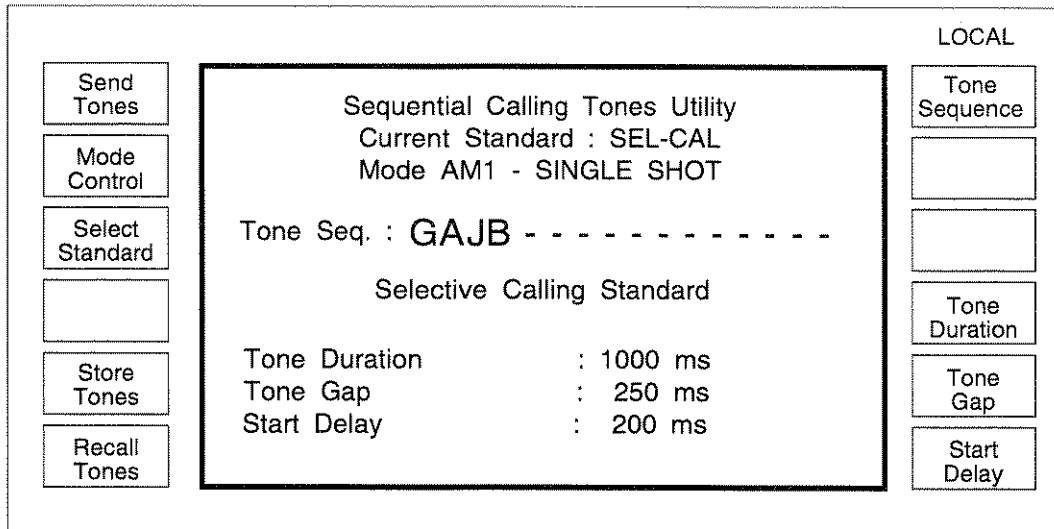

C0537

Fig. A-18 SEL-CAL tones utility

Tone sequences are entered using the [Tone Sequence] key to produce the display shown in Fig. A-19.

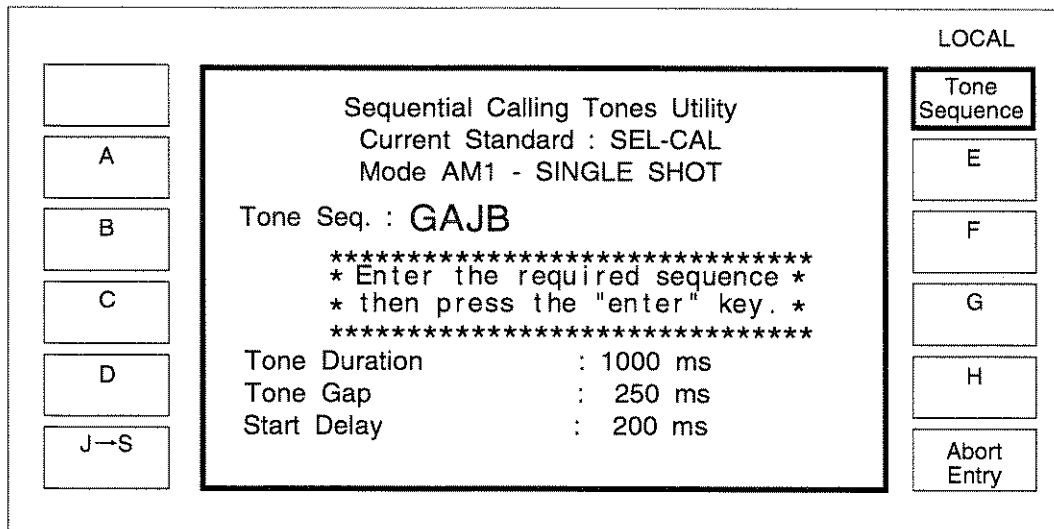

C0538

Fig. A-19 SEL-CAL tone entry

Characters A to H may be directly entered. To enter characters J to S first select the key [J→S]. An even number of characters is required to be entered up to a maximum of 4 (2 pairs). When the entry is complete terminate the code using the [enter] key. The display will return to that shown in Fig. A-18.

Note...

The SEL-CAL calling tones can also be selected from the Sequential Calling Tones Utility used for other calling tone standards. In this mode FM is also allowed.

Rotary control

The rotary control can be used to vary major parameters in all Avionics modes by pressing the [KNOB UP-DN] key. The sensitivity of the rotary control can be changed using the [↑] and [↓] keys.

GPIB OPERATION

MODE

Set avionics mode
(in addition to existing modulation mode commands)

Data type : Character Program Data (valid combinations of SDM, DDM, VOR, BEAR or AM2, see Table below)
Allowed suffices : None
Default suffix : None

Examples: MODE SDM,DDM (select ILS mode with DDM)
MODE SDM,AM2 (select ILS mode with AM2)
MODE SDM (select ILS variable phase mode)

VALID MODE COMBINATION TABLE

ILS	VOR
SDM, DDM	VOR, BEAR
SDM, AM2	VOR, AM2

NOTE...

Order is not important, for example SDM,DDM is equivalent to DDM,SDM.

MODE?

Prepares message containing information on Modulation Mode in the following format:

:MODE<mode>

where: <mode> is character program data indicating the modulation mode settings.

Examples: :MODE VOR, BEAR
:MODE SDM, DDM
:MODE SDM

ILS (Instrument Landing System) mode

SDM Set Sum of Depth of Modulation (short form)

:DEPTH Set SDM Depth

:INC Set SDM step size

Data type : Decimal Numeric Program Data

Allowed suffices : **PCT**

Default suffix : **PCT**

:UP Go UP one step

:DN Go DOWN one step

:RETN Return to original setting

:XFER Transfer current value to be the new setting

Data type : None

Allowed suffices : None

Default suffix : None

Example: `SDM:DEPTH 40PCT;INC 2;UP;UP;UP`

:PHASE Specify the phase relationship between the 90 Hz and 150 Hz tones.

Data type : Character Program Data (any one of SIN_SIN, COS_COS or SIN_COS).

Allowed suffices : None

Default suffix : None

Example: `SDM:PHASE SIN_COS`

SDM? Prepares messages containing information on SDM in the following format:
`:SDM:DEPTH <nr2>;INC <nr2>`

Example: `:SDM:DEPTH 40.0;INC 0.5`

SDM:PHASE? Prepares messages containing information on the phase relationship between the 90 Hz and 150 Hz tones in the format:
`:SDM:PHASE <char>`

Example: `:SDM:PHASE SIN_COS`

DDM90 Set Difference in Depth of Modulation with 90 Hz tone predominant (short form)

:DEPTH Set DDM90 Depth

DDM150 Set Difference in Depth of Modulation with 150 Hz tone predominant (short form)

:DEPTH Set DDM150 Depth

DDM90 or DDM150

:INC

Data type : Decimal Numeric Program Data

Allowed suffices : **PCT**

Default suffix : **None**

Note...

When there is no suffix it is assumed that the entry is in DDM index (%/100).

:UP Go UP one step
:DN Go DOWN one step
:RETN Return to original setting
:XFER Transfer current value to be the new setting

Data type : None
Allowed suffices : None
Default suffix : None

Examples: DDM90:DEPTH 40PCT;INC 0.1;DN;DN
DDM150:DEPTH 0.1554;INC 0.0002;UP;UP;UP

DDM? Prepares messages containing information on DDM in the following format:

:<ddm>;DEPTH <nr2>;INC <nr2>

where <ddm> is a program mnemonic indicating the predominant tone (DDM90 or DDM150).

Examples: :DDM90:DEPTH 0.2000;INC 0.01
:DDM150:DEPTH 0.4000;INC 0.01

SUPPRESS

[not used alone]
:TONE90 Suppress the 90 Hz tone
:TONE150 Suppress the 150 Hz tone
:NONE Remove tone suppression

Data type : None
Allowed suffices : None
Default suffix : None

Examples: :SUPPRESS;TONE150
:SUPPRESS:NONE

SUPPRESS? Prepares messages containing information on tone suppression control in the following format:

:SUPPRESS:<status>

where: <status> is a program mnemonic indicating the tone suppression state.

ILSF

:VALUE Set ILS Frequency (short form)
:INC Set ILS Frequency

Data type : Decimal Numeric Program Data
Allowed suffices : **GHz, MHz, KHz, Hz**
Default suffix : **Hz**

:UP Go UP one step
:DN Go DOWN one step
:RETN Return to original setting
:XFER Transfer current value to be the new setting

Data type : None
Allowed suffices : None
Default suffix : None

Example: ILSF:VALUE 30 Hz;INC 0.1;DN;DN;DN

ILSF?

Prepares messages containing information on ILS Frequency in the following format:

:ILSF:VALUE <nr2>;INC <nr2>

Example: :ILSF:VALUE 30.0;INC 0.5

Marker beacon mode

There are no additional commands for marker beacon testing, the required setting is obtained by using the appropriate standard commands.

Example for setting up and sending 400 Hz outer marker beacon:

```
Example: :CFRQ 75 MHZ;RFLV:VALUE 0 DBM;ON;:AM1:DEPTH  
95 PCT;INTF1;ON;:INTF1 400 HZ;:MOD:ON;:MODE AM
```

Example for setting up and sending 1300 Hz middle marker beacon:

```
Example: :CFRQ 75 MHZ;RFLV:VALUE 0 DBM;ON;:AM1:DEPTH  
95 PCT;INTF1;ON;:INTF1 1300 HZ;:MOD:ON;:MODE AM
```

Example for setting up and sending 3000 Hz inner marker beacon:

```
Example: :CFRQ 75 MHZ;RFLV:VALUE 0 DBM;ON;:AM1:DEPTH  
95 PCT;INTF1;ON;:INTF1 3000 HZ;:MOD:ON;:MODE AM
```

VOR (VHF Omnidirectional Radio Range) mode

VOR or SUB Set SUB Subcarrier Signal (9960 Hz) Depth (short form)
:DEPTH Set SUB Depth
:INC Set SUB step size

Data type : Decimal Numeric Program Data
Allowed suffices : **PCT**
Default suffix : **PCT**

:UP Go UP one step
:DN Go DOWN one step
:RETN Return to original setting
:XFER Transfer current value to be the new setting
:ENABLE Enable Subcarrier and variable signal depth coupling
:DISABLE Disable Subcarrier and variable signal depth coupling

Data type : None
Allowed suffices : None
Default suffix : None

Example: SUB:DEPTH 30PCT;INC 2;UP;UP;UP
:DEVN Specify Subcarrier deviation

Data type : Character Program Data (any one of Hz_420, Hz_450, Hz_480, Hz_510 or Hz_540)
Allowed suffices : None
Default suffix : None

VOR? or SUB? Example: :VOR:DEVN HZ_450
Prepares messages containing information on SUB in the following format:

:SUB:DEPTH<nr2>;INC<nr2>

Example: :SUB:DEPTH 30.0;INC 0.5;DISABLE

VOR:DEVN? Prepares messages containing information on VOR Subcarrier deviation selection in the format:

:VOR:DEVN<char>

Example: :VOR:DEVN HZ_480

REF Set REF Variable Signal (30 Hz) Depth (short form)
:DEPTH Set REF Depth
:INC Set REF Step Size

Data type: Decimal Numeric Program Data
Allowed suffices : **PCT**
Default suffix : **PCT**

:UP Go UP one step
:DN Go DOWN one step
:RETN Return to original setting
:XFER Transfer current value to be the new setting

Data type : None
Allowed suffices : None
Default suffix : None

Example: REF:DEPTH 30PCT;INC 2;DN;DN;DN

REF? Prepares messages containing information on REF in the following format:

:REF:DEPTH <nr2>;INC <nr2>

Example : :REF:DEPTH 30.0;INC 0.5

BEARTO Set VOR Bearing To Beacon (short form)

:VALUE Set VOR Bearing To Beacon

BEARFR Set VOR Bearing From Beacon (short form)

:VALUE Set VOR Bearing From Beacon

BEARTO or BEARFR

:INC

Data type: Decimal Numeric Program Data
Allowed suffices : **DEG**
Default suffix : **DEG**

:UP Go UP one step
:DN Go DOWN one step
:RETN Return to original setting
:XFER Transfer current value to be the new setting

Data type : None
Allowed suffices : None
Default suffix : None

Examples: BEARTO:VALUE 90DEG;INC 0.1;UP;UP;UP
BEARFR:VALUE 270DEG;INC 0.1;DN;DN;DN

BEAR? Prepares messages containing information on VOR BEARING in the following format:

:<bear>:VALUE <nr2>;INC <nr2>

where <bear> is a program mnemonic indicating the Bearing convention (BEARTO or BEARFR).

Examples: :BEARFR:VALUE 60.0;INC 0.5
:BEARTO:VALUE 300.0;INC 0.5

VORF Set VOR Frequency (short form)

:VALUE Set VOR Frequency

:INC

Data type: Decimal Numeric Program Data
Allowed suffices : **GHz, MHz, KHz, Hz**
Default suffix : **Hz**

:UP Go UP one step
:DN Go DOWN one step
:RETN Return to original setting
:XFER Transfer current value to be the new setting

Data type : None
Allowed suffices : None
Default suffix : None

Example: VORF:VALUE 30Hz;INC 0.1;DN;DN;DN

VORF?

Prepares messages containing information on VOR Frequency
in the following format:

:VORF:VALUE <nr2>;INC <nr2>

Example : :VORF:VALUE 30.0;INC 0.5

ADF (Automatic Direction Finder) mode

There are no additional commands for ADF testing, the required setting is obtained by using the appropriate standard commands.

Example: :CFRQ 190 KHZ;RFLV:VALUE +10 DBM;ON;:AM1:
DEPTH 30 PCT;INTF1;ON;:INTF1 1 KHZ;:MOD:ON;:MODE AM

Sel-cal mode

SEL-CAL adds the following to the Sequential Calling Tones. SEL-CAL is an additional valid type. The data string representing the Tone Sequence is an even number of characters selected from the set {ABCDEFGHIJKLMQRS}.

Example for setting operating conditions:

Example: :CFRQ 118 MHZ;RFLV:VALUE 0 DBM;ON;:AM1:DEPTH
80 PCT;INTF1;OFF;:INTF1 1 KHZ;:MOD:ON;:MODE AM

Example for setting up SEL-CAL and sending tones:

Example: :SEQT:MODE:STD SELCAL;MOD AM1;:SEQT:SEQ
"GABD";SEND 1

ACCEPTANCE TESTING

Introduction

The test procedures in this section enable you to verify that the electrical performance of the avionics signal generator complies with the Performance Data given earlier. The test equipment recommended for this purpose is listed in Table A-1. All tests may be performed with the covers in place and are intended to be carried out in the order given. For convenience, the test equipment and specification for each test are summarized before the test procedure. These tests are in addition to those for non-avionics versions of the instrument.

These acceptance tests give a high degree of confidence that the instrument meets its specification, without the use of specialised test equipment.

The avionics option uses a method of Direct Digital Synthesis (DDS) to generate the required avionics waveforms. The accuracy of the generated waveform is therefore determined by stored digital data and the AM performance of the signal generator. These tests check the waveform generation and analogue and RF signal paths in the signal generator. Additional tests can be undertaken using specialised ILS and VOR receivers if they are available.

Test equipment

The test equipment recommended for acceptance testing is shown in Table A-1. Alternative equipment may be used provided it complies with the stated minimum specification.

TABLE A-1 RECOMMENDED TEST EQUIPMENT

TEST EQUIPMENT		
Description	Minimum specification	Example
Spectrum analyzer	DC to 400 MHz Level accuracy ± 1 dB	IFR 2382
Modulation meter	500 kHz to 1 GHz AM accuracy $\pm 1\%$ of reading Selectable ILS filter	IFR 2305
Oscilloscope	100 MHz bandwidth	Tektronix 2235

Functional testing of ILS waveform generation

TEST EQUIPMENT		
Description	Minimum specification	Example
Spectrum analyzer	100 Hz to 400 MHz	IFR 2382
Oscilloscope	100 MHz bandwidth	Tektronix 2235

IFR uses a method of Direct Digital Synthesis (DDS) to generate the ILS waveforms. One DDS generated waveform contains both the 90 Hz tone and the 150 Hz tone with 0% DDM (Difference Depth of Modulation).

A second waveform is generated with 0% DDM but with the relative phase of the 150 Hz tone reversed compared to that of the 90 Hz tone.

When small levels of the second waveform are added to the first, the resultant waveform has a constant SDM and adding a proportion of the second waveform will result in the DDM of the resultant signal changing.

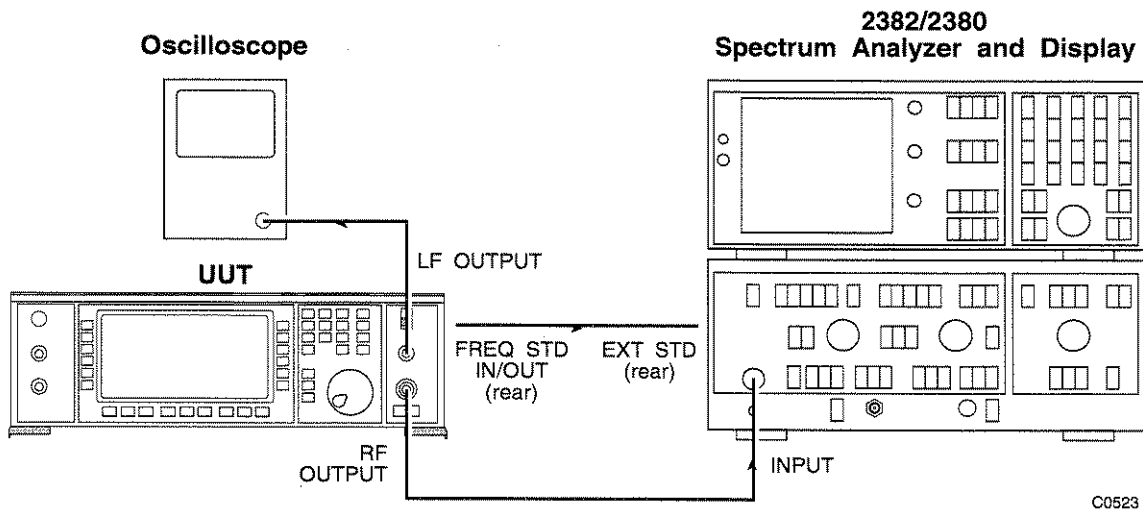

Fig. A-20 ILS functional test set-up

- (1) Connect the test equipment as shown in Fig. A-20.
- (2) Set up the test equipment as follows:-

Unit under test

ILS mode	
Carrier freq	108.1 MHz
RF level	7 dBm
SDM	40 %
ILS rate	30 Hz
DDM	0 %
90 Hz dominant	Fly RT

Oscilloscope

Volts/div	0.2 V
Time base	5 ms/div

Spectrum analyzer

Reference frequency	108.1 MHz
Reference level	10 dBm
Span/div	50 Hz
Resolution bandwidth	10 Hz

- (3) The typical traces on the oscilloscope and the spectrum analyzer are shown in Figs. A-21 and A-22. These traces are for the 90 Hz and the 150 Hz tones' having equal amplitudes (i.e. 0% DDM).

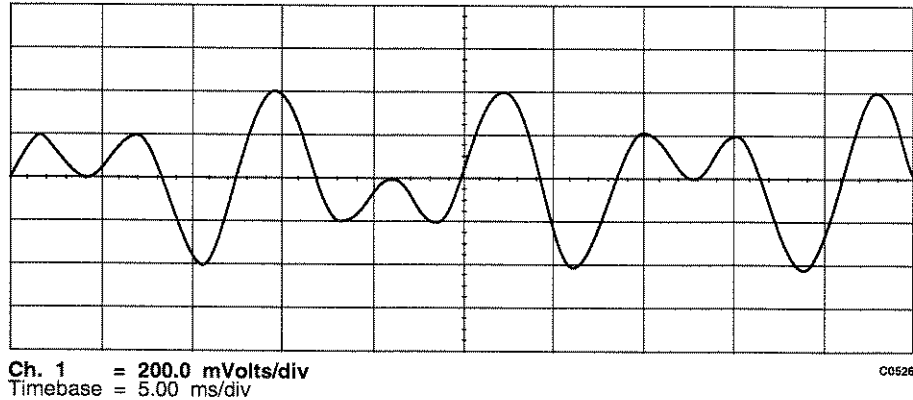

Fig. A-21 Oscilloscope trace for a 0% DDM waveform.

- (4) On the UUT reduce the SDM depth using the rotary control. This will cause a reduction in the amplitude of the oscilloscope trace and the sidebands on the spectrum analyzer trace. Reset the SDM to 40%.

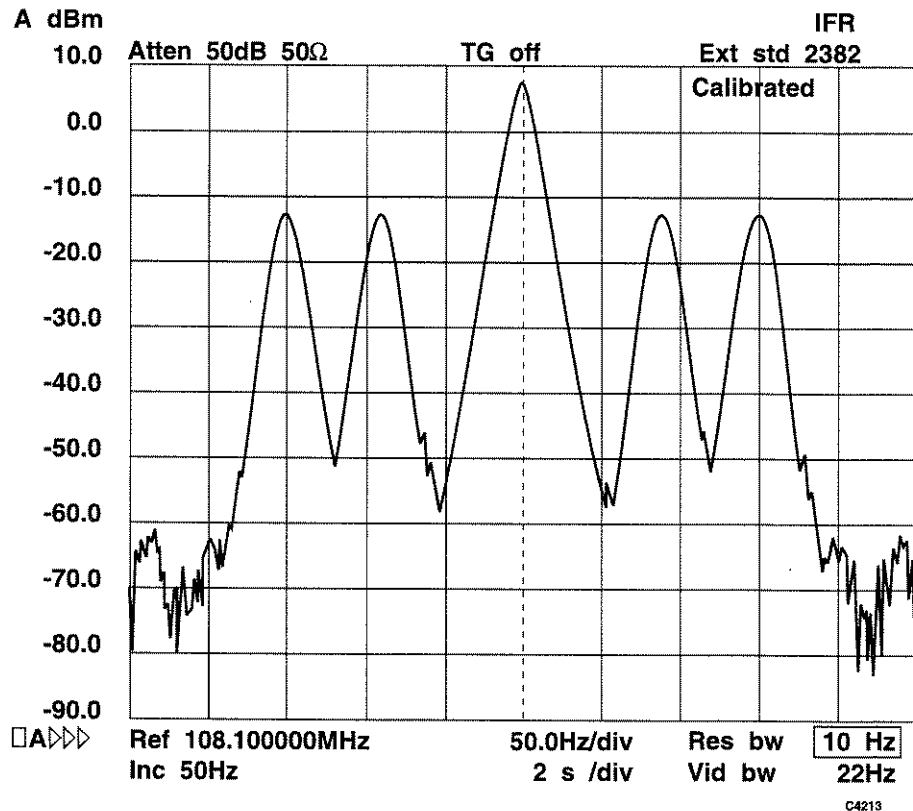
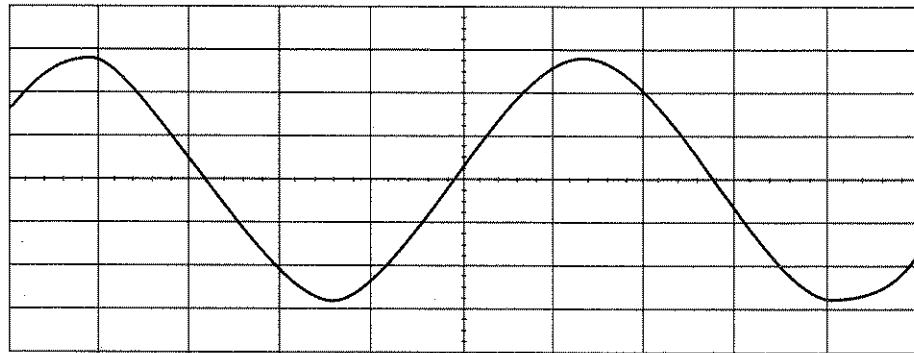

Fig. A-22 Spectrum analyzer trace for a 0% DDM waveform.

- (5) On the UUT select DDM. Increase the DDM from 0% to 40% using the knob control. As the change occurs, the 90 Hz sideband should increase and the 150 Hz sideband should decrease. For a signal with a DDM of 40% the 150 Hz sideband will be suppressed as shown in Figs. A-23 (the trace is 2 ms/div) and A-24.



Ch. 1 = 200.0 mVolts/div
Timebase = 2.00 ms/div

C0524

Fig. A-23 Oscilloscope trace for a 40% DDM waveform.

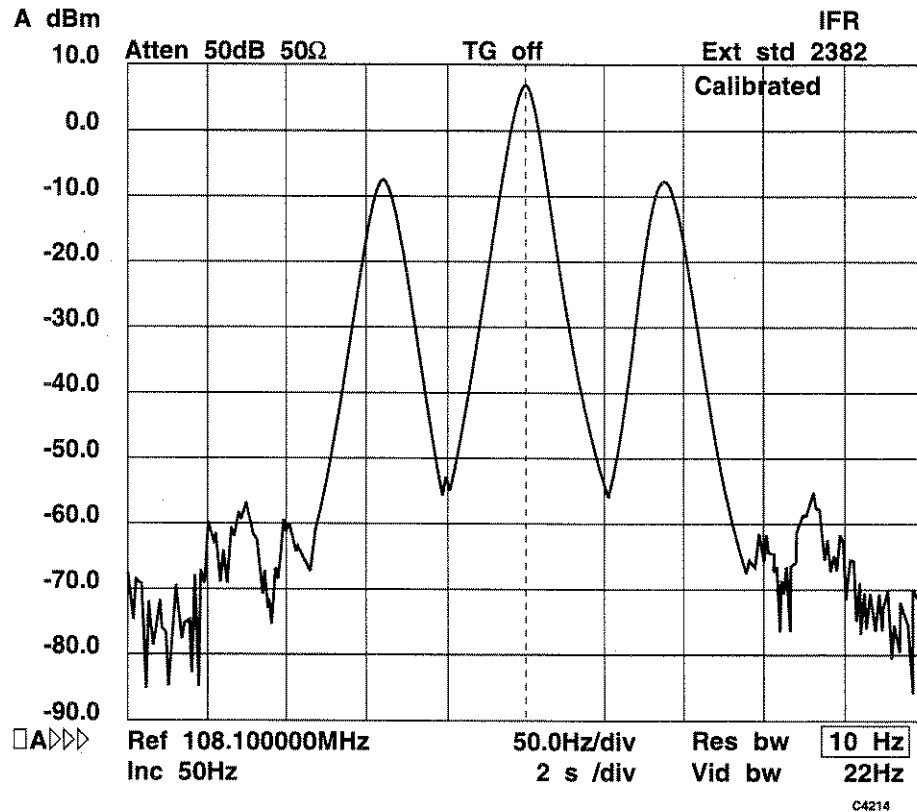

Fig. A-24 Spectrum analyzer trace for a 40% DDM waveform.

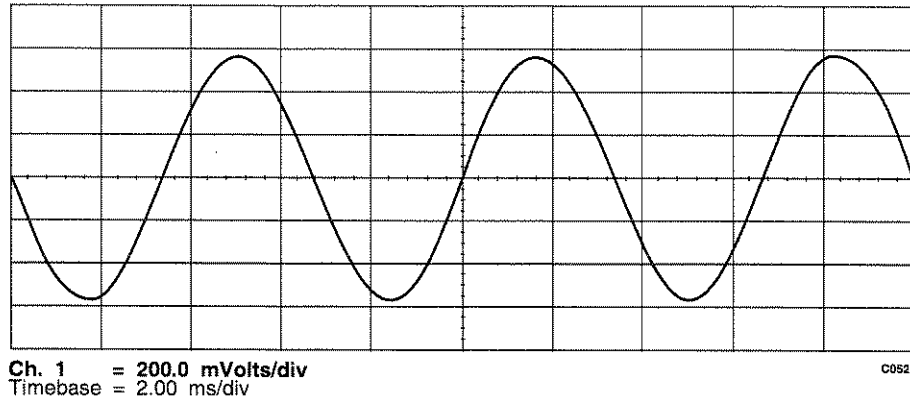
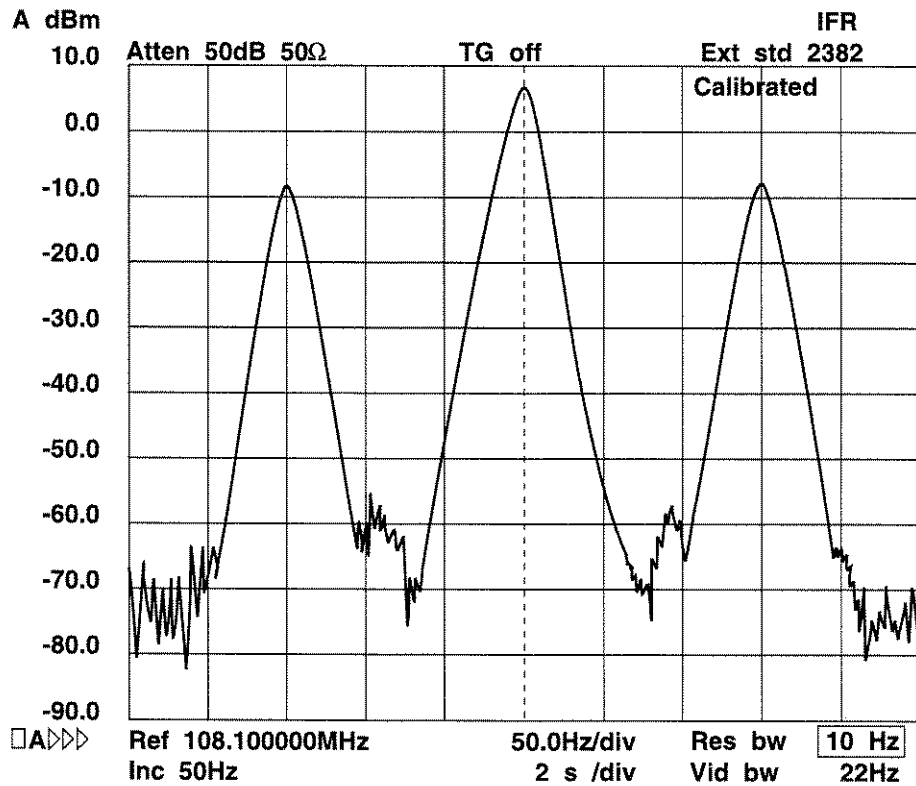

Fig. A-25 Oscilloscope trace for a 150 Hz dominant waveform.

- (6) On the UUT select the 150 Hz tone to be dominant. The 90 Hz sideband should be suppressed and the 150 Hz sideband should be present as shown in Figs. A-25 (the trace is 2 ms/div) and A-26.



C4215

Fig. A-26 Spectrum analyzer trace for a 150 Hz dominant waveform.

Accuracy of SDM (Sum Depth of Modulation) signal path

SPECIFICATION

±2% of setting for carrier frequencies up to 400 MHz

The signal generator has a 1 dB AM bandwidth from DC to at least 30 kHz and consequently the difference in AM response between 90 Hz and 150 Hz will be small and can be neglected. Because of this, it is possible to test the SDM and the DDM accuracy of the instrument by the use of a single tone modulation at 124 Hz rate (the geometric mean of 90 Hz and 150 Hz).

The 0% DDM signal is generated using the AM 1 channel. The phase shifted signal is generated on the AM 2 channel. The design of the instrument ensures that the AM accuracy of each channel at a fixed frequency is equal to the accuracy of the ILS waveform generated by the instrument.

TEST EQUIPMENT

Description	Minimum specification	Recommended
Modulation meter*	50 kHz to 1 GHz AM accuracy ±0.5% of reading at 40% depth ±0.7% of reading at 80% depth Selectable ILS filter	IFR 2305

*The SDM and DDM accuracy of the Avionics Option can not be verified with a modulation meter calibrated to its published performance specification. A specially calibrated modulation meter is necessary. If more than an approximate verification is required, consult your local IFR agent or the Service Division for further details.

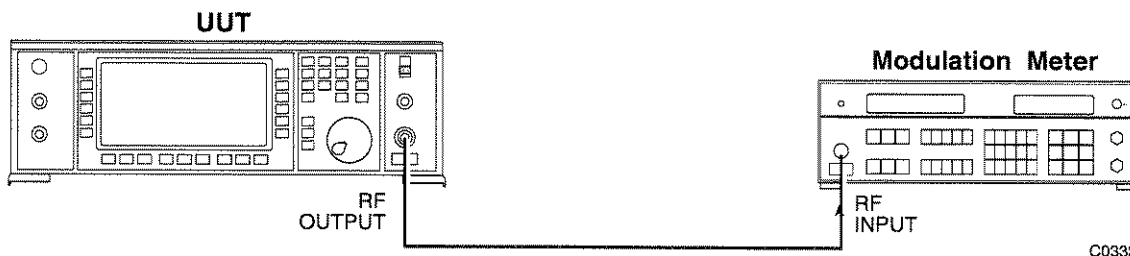

C0332

Fig. A-27 Accuracy of SDM signal path test set-up

- (1) Connect the test equipment as shown in Fig. A-27.
- (2) Set up the test equipment as follows:-

Unit under test

```
[UTIL] [Mod'n Mode] [Composite]
[SIG GEN]
Carrier freq          108.1 MHz
RF level              7 dBm

[AM]
AM 1 depth            40 %
[Select Source] [Internal F1] 120 Hz sinewave
[SIG GEN]
AM 1                  Off
```

AM 2 depth 0 %
 [Select Source] [Select Internal] [Internal F2] 124 Hz sinewave
 [SIG GEN]
 AM 2 Off

Modulation meter

tune Autotune
 Function AM
 Second function 28 On (see note)

Note...

In order to select second function 28 it is first necessary to unlock the 2305 to its 1st level of protection (this is detailed in the operating manual).

Second function 28 selects an ILS filter. This is a 15 kHz low-pass filter selected separately from, and without any accompanying high-pass section. This provides sufficient high frequency bandwidth for the AM ILS signal without admitting an excessive amount of noise. In the left-hand window a 1 selects the filter and a 0 deselects it.

- (3) With AM channels 1 and 2 turned off, allow the modulation meter reading to settle, then measure the residual AM noise and note the reading.

Residual AM noise depth _____ %

- (4) On the UUT turn the AM 1 channel on. Allow the reading on the modulation meter to settle and note it. (This is equivalent to an SDM of 40 %.)

Measured AM depth _____ %

Actual AM depth = Measured AM depth - Residual AM noise

Set AM	Minimum	Actual	Maximum
40%	39.2%	_____ %	40.8%

- (5) Repeat (4) for an AM 1 depth of 80% (this is equivalent to an SDM of 80%) with the carrier frequency set to 330 MHz.

Set AM	Minimum	Actual	Maximum
80%	78.4%	_____ %	81.6%

Accuracy of DDM (Difference Depth of Modulation) waveform

SPECIFICATION
±0.03% of depth ±0.02 of setting

This specification is checked by measuring the modulation channel balance at 19.9% and 40% SDM (with and without final divide-by-5 internal attenuator).

TEST EQUIPMENT		
Description	Minimum specification	Example
Spectrum analyzer or FFT analyzer	DC to 25 kHz 3 Hz filter	IFR 2382

- (1) Connect the test equipment as shown in Fig. A-28.

- (2) Set up the test equipment as follows:-

Unit under test

ILS mode	
Carrier freq	108.1 MHz
LF output	Monitor AM drive
SDM	40%
DDM	0%
Dominant tone	90 Hz

Spectrum analyzer

Span/div	20 Hz
Frequency	0 to 200 Hz
Ref level	20 dBm
Resolution bandwidth	3 Hz
Input	DC coupled

The spectrum analyzer should display equal amplitude tones of 90 Hz and 150 Hz.

- (3) Reset the test equipment as follows:

Unit under test

DDM	40%
-----	-----

The 150 Hz tone should now be suppressed. Check that the residual level is at least 52 dB lower than the 90 Hz tone.

- (4) Reset the test equipment as follows:

Unit under test

SDM	19.9%
DDM	19.9%

The 150 Hz tone should still be suppressed. Check that the residual level is at least 52 dB lower than the 90 Hz tone.

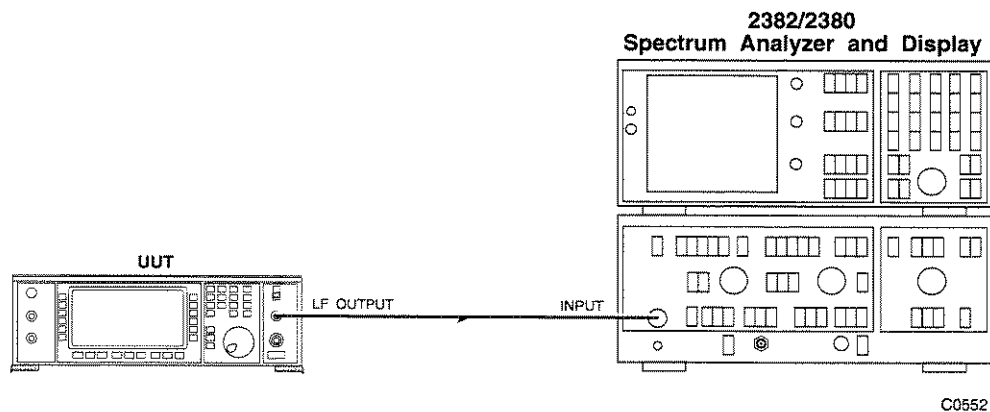

Fig. A-28 Equipment configuration for DDM waveform accuracy

VOR waveform depth accuracy

SPECIFICATION

±3% of setting ±0.5% for carrier frequencies up to 400 MHz

TEST EQUIPMENT

Description	Minimum specification	Example
Modulation meter	Freq range to 400 MHz AM accuracy ±1% of reading Selectable ILS filter	IFR 2305

(1) Connect the test equipment as shown in Fig. A-27.

(2) Set up the test equipment as follows:-

Unit under test

VOR mode

Carrier freq 108 MHz

RF level 7 dBm

SUB depth 0 %

REF depth 0 %

Modulation meter

Freq tune 108 MHz

Function AM

Second function 28 On

(3) With SUB and REF set to 0% measure the residual AM noise. Note the reading.

Residual AM noise depth _____ %

(4) On the UUT select a SUB depth of 30% and a REF depth of 0%. Allow the reading on the modulation meter to settle and note it.

Measured AM depth _____ %

Actual SDM = Measured AM depth - Residual AM noise

Minimum	Actual	Maximum
28.60%	_____ %	31.40%

Ensure that the measured depth is in specification.

(5) Repeat (4) for a SUB depth of 0% and a REF depth of 30%.

Minimum	Actual	Maximum
28.60%	_____ %	31.40%

(6) Repeat (4) for a SUB depth of 30% and a REF depth of 30%.

Minimum	Actual	Maximum
57.70	_____ %	62.30%

VOR waveform test

TEST EQUIPMENT		
Description	Minimum specification	Example
Spectrum analyzer or FFT analyzer	DC to 25 kHz 3 Hz filter	IFR 2382

(1) Connect the test equipment as shown in Fig. A-28.

(2) Set up the test equipment as follows:

Unit under test

VOR mode

SUB depth 30%

REF depth 30%

Spectrum analyzer

Span/div 200 Hz

Ref freq 9.96 kHz

Ref level 10 dBm

Bandwidth 30 Hz

(3) Check that a display similar to that shown in Fig. A-29 is obtained. This shows the presence of the 9.96 kHz sub-carrier with 30 Hz rate, 480 Hz deviation frequency modulation present.

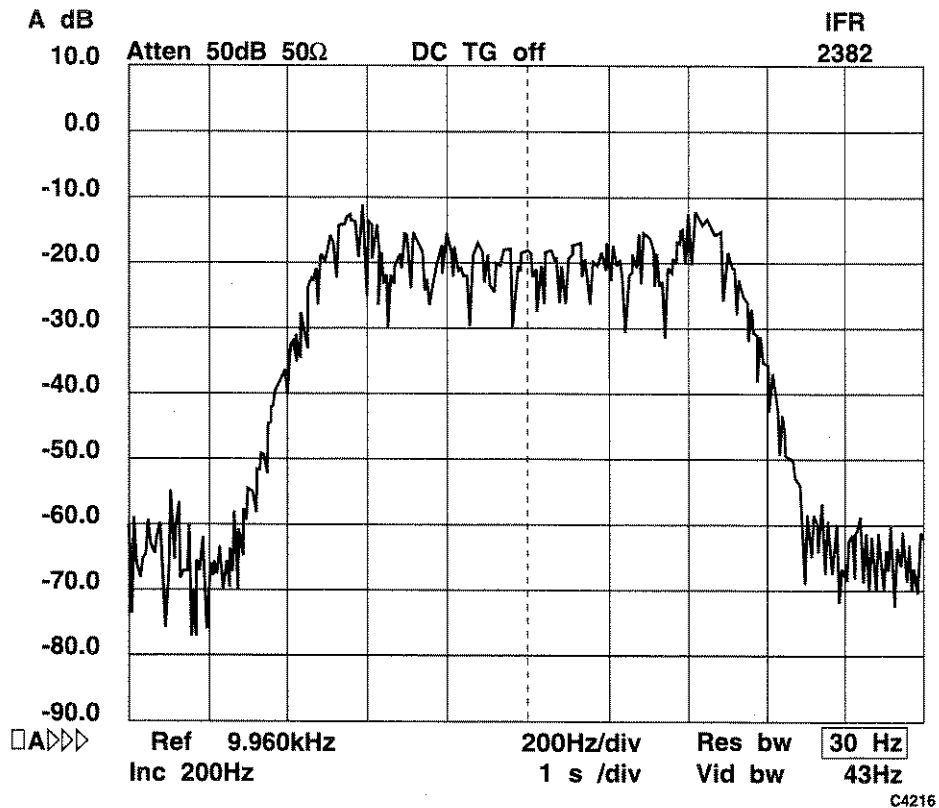

Fig. A-29 9.96 kHz sub-carrier with frequency modulation

Waveform phase control

This test is a functional test of the phase control system used on the DDS sources. The two sources are set to the same frequency and their outputs are summed together. As the relative phase of the source is changed the resulting signal amplitude will change.

TEST EQUIPMENT		
Description	Minimum specification	Example
Oscilloscope	100 MHz bandwidth	Texttronix 2235

- (1) Connect the test equipment as shown in Fig. A-30.

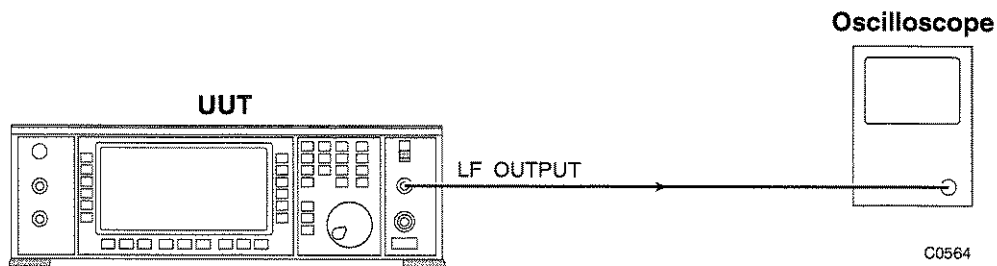

Fig. A-30 Waveform phase control test set-up

- (2) Set up the test equipment as follows:

Unit under test

[UTIL] [Mod'n Mode] [Composite]
[SIG GEN]

LF output	Modulation monitor
Modulation drive	
AM1	30% ON
AM2	30 % ON
INT F1	30 Hz
INT F2	30 Hz

Set AM1 source to INT F1
Set AM2 source to INT F2

Oscilloscope

Set to monitor LF OUTPUT waveform .

- (3) On the UUT select the Internal Source Selection menu and press the [Mod. Src Phase] key. Enter a phase of 0° (to beacon).
Check that the LF OUTPUT is approximately 1.69 V pk-pk.
- (4) Enter a phase of 180° . Check that the output tone is substantially suppressed to a level less than 80 mV pk-pk.
- (5) Enter a phase of 90° and check that the output tone is approximately 1.2 V pk-pk.
- (6) Enter a phase of 270° and check that the output tone has the same amplitude as in (5) above.



Annex B

OPTION 008 RF PROFILES AND COMPLEX SWEEP

CONTENTS

	PAGE
PERFORMANCE DATA	B-2
INTRODUCTION TO OPTION 008	B-4
RF OFFSET AND PROFILES	B-4
Access to RF offset and profile	B-5
RF OFFSET.....	B-6
RF PROFILES.....	B-7
Creating a profile	B-8
Enabling a profile.....	B-9
Tutorial examples for rf offset and profiles	B-10
SEQUENCE SWEEP	B-12
Selecting a sequence sweep.....	B-13
Modifying segments.....	B-14
Entering a sweep sequence	B-14
Sweep mode	B-14
Starting to sweep.....	B-15
Tutorial examples for sequence sweep	B-16
COMPLEX SWEEPS	B-17
RF profiles, offset and sequence sweep	B-17
Suppressing attenuator changes	B-17
Tutorial example for immunity testing.....	B-17
SQUARE WAVE MODULATION	B-18
GPIB OPERATION.....	B-19
Segmented sweeps.....	B-19
RF profiles.....	B-21
RF offsets	B-23

LIST OF FIGURES

Fig. B-1 Utilities selection menu 2	B-5
Fig. B-2 RF level utility menu.....	B-5
Fig. B-3 RF offset selection (shown unlocked to Level 1).....	B-6
Fig. B-4 Main signal generator screen with RF offset enabled	B-7
Fig. B-5 RF profile menu (shown unlocked to Level 1).....	B-7
Fig. B-6 RF profile editor menu.....	B-8
Fig. B-7 Main signal generator screen with RF offset and profiles enabled	B-10
Fig. B-8 Two signal generator testing with a resistive combiner.....	B-10
Fig. B-9 Using a signal generator with an external amplifier.....	B-11
Fig. B-10 Example for a segmented sweep	B-12
Fig. B-11 Sweep type menu.....	B-13
Fig. B-12 Sweep sequence selection menu.....	B-13
Fig. B-13 Sweep segment editor.....	B-14
Fig. B-14 Sweep menu display with the sweep halted	B-15

PERFORMANCE DATA

General description

Option 008 software provides additional sweep, RF offset and RF level profiling facilities to support the use of 2050 series Signal Generators with external amplifiers and attenuators. The RF output from the external device can be calibrated and displayed on the front panel of the signal generator using the RF offset and RF profile facilities.

The following specification is in addition to the specification for the 2050 series Signal Generators.

RF offsets

The displayed signal generator output level can be offset by +80 dB to -40 dB (in 0.1 dB steps) from the actual RF output level. Up to 5 offsets values may be defined and selected in turn.

RF offsets can be enabled and disabled and their value and status stored in non-volatile memory. RF offsets may be used in normal signal generator modes or combined with the segmented sweep facility.

RF profile

The actual RF output level can be adjusted by ± 40 dB from its nominal value without changing the displayed level. Up to 10 profiles may be defined and selected in turn. RF profiles can be enabled and disabled and all RF profile information can be stored in non-volatile memory.

Profile values can be entered at up to 100 carrier frequencies.

The RF output level is linearly interpolated between profile points.

RF profiles may be used in normal signal generator modes or combined with the segmented sweep facility to produce complex sweeps.

Segmented sweep

Carrier frequency sweeps can be generated which contain defined segments each of which can have a different step size, start and stop frequency, step time and RF level.

Start and stop

Start and stop frequency for each segment can be freely defined within the frequency capability of the signal generator.

Step size

Minimum step size is 0.1 Hz.

Maximum step size is determined by the frequency capability of the signal generator.

Number of steps for a particular segment is implied by the step size and the start and stop frequencies.

Step time

20 ms to 20 s per step.

RF level

The RF level for each segment can be freely defined within the output level capability of the signal generator.

Segments

Up to 10 segments may be defined and freely combined in any order to produce a segmented sweep. Segmented sweeps can be stored in non-volatile memory by using the sweep stores (0 to 19).

MODULATION WAVEFORMS

Sine, triangle or square wave modulation is available to provide amplitude, phase or frequency modulation.

INTRODUCTION TO OPTION 008

This section describes how to use the additional software features provided when Option 008 RF profile and complex sweep is fitted to a 2050 series Signal Generator. Familiarity with normal operation of the signal generator is assumed.

Option 008 provides two principle facilities. The RF offset facility enables the user to effectively display the RF output level when the signal generator is connected to an external device, such as an attenuator or an amplifier. If the external device gain or loss is frequency dependent then the signal generator can substantially eliminate the frequency dependence using RF profiles.

The segmented sweep facility allows for the generation of sweeps where the sweep is split into segments which can have independent start, stop, step size, step time and RF levels. The complex sweeps are generated using the segmented sweep mode and can be used in combination with the RF profile and RF offset facility. This is particularly useful for electromagnetic immunity and Tempest testing.

Complex sweeps can be generated by combining the RF offset, RF profile and segmented sweep facilities.

RF OFFSET AND PROFILES

These facilities provide the capability for setting the signal generator to display the RF power at the output of a device connected to the signal generator. The RF offset facility is used to compensate for the nominal gain (or loss) of the external device. Adding an offset value does not change the RF output level of the signal generator but does change the displayed RF output level. If, for example, the signal generator is connected to a 20 dB amplifier the offset value can be set to +20 dB. If the signal generator output level is set to +20 dBm then +20 dBm is displayed but the actual signal generator output level will be 0 dBm.

The RF profile facility allows the output level to be corrected to allow for frequency dependent gain (or loss) errors. If, for example, the gain of the amplifier at 100 MHz is 20 dB, at 150 MHz it is 19 dB and at 200 MHz it is 19.5 dB the RF profile facility can introduce 0 dB, 1 dB and 0.5 dB level compensation at 100 MHz, 150 MHz and 200 MHz respectively to compensate for the frequency/gain errors. The RF level profile is linearly interpolated between these frequencies to minimise level errors at intermediate frequencies.

The profile values do not change the displayed RF level but do change the RF output level of the signal generator.

Access to RF offset and profile

The RF offsets and profiles are initially accessed via the *Utilities Selection Menu 2*. To obtain this menu, press [UTIL]. If the *Utilities Selection Menu 1* is displayed, press the [Utils. Menu 2] key. The required display is shown in Figure B-1.

Note...

If the utility facility has already been previously accessed it may be necessary to press the [UTIL] key a second time and then select [Utils. Menu 2].

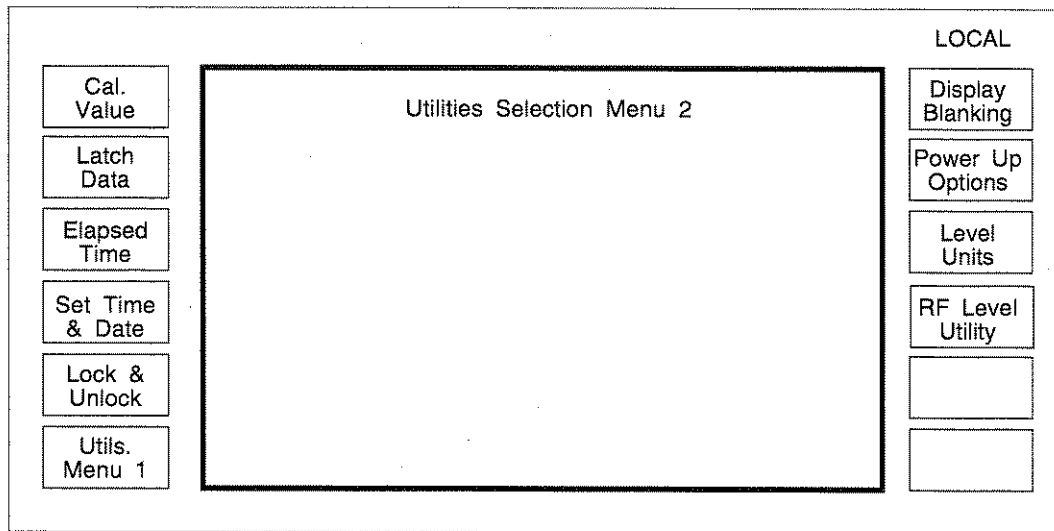

Fig. B-1 Utilities selection menu 2

Press [RF Level Utility] to obtain the display shown in Fig. B-2. The [Offsets] or [Profiles] key can now be selected as required.

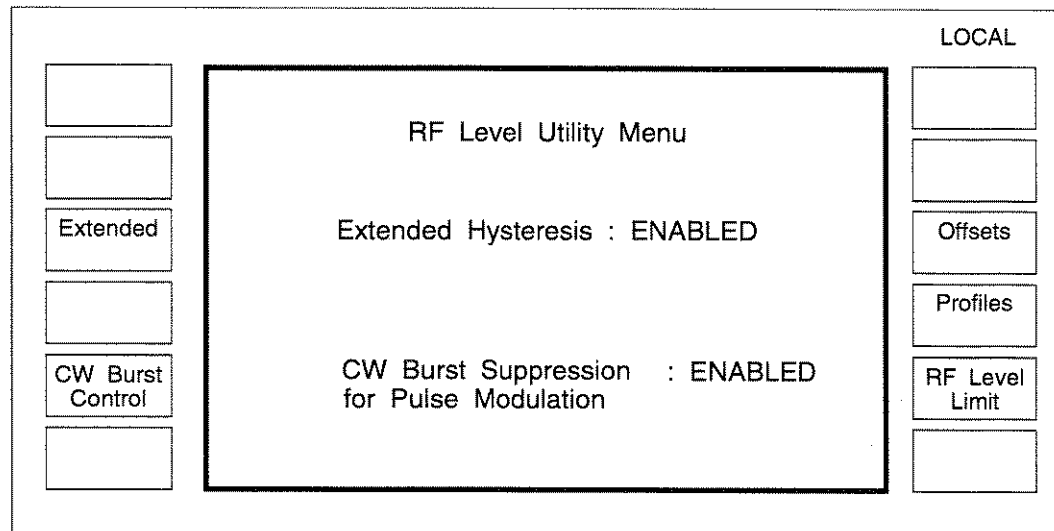
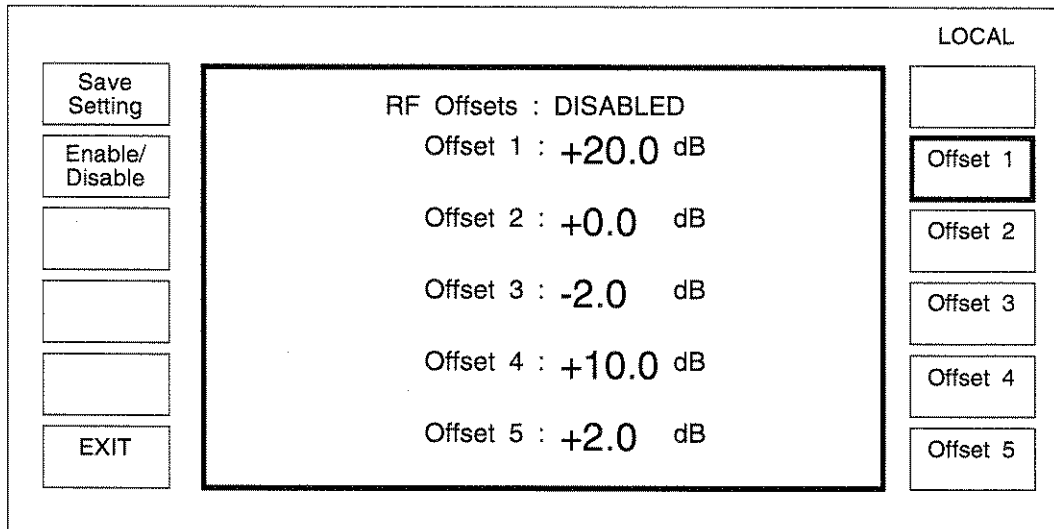

Fig. B-2 RF level utility menu ([CW Burst Control] and associated text only appears when the relevant option is fitted)

RF OFFSET

Selecting the *[Offsets]* key will result in a display similar to that shown in Fig. B-3. But note that the *[Save Setting]* key will only appear if the instrument has been unlocked to Level 1.



C0862

Fig. B-3 RF offset selection (shown unlocked to Level 1)

Selecting one of the *[Offset]* keys will allow an offset of up to +80 dB to -40 dB to be entered using the numerical key pad and the [dB] terminator key. Any of the five offset values may be selected by pressing the appropriate soft key.

The offset values can be changed at any time. The set of values displayed when the instrument is first switched on can also be changed by the user. The generator should be unlocked to Level 1 so that the *[Save Setting]* key is displayed. If the offset values are then changed to the required power up settings and the *[Save Setting]* key is pressed the values are stored in non-volatile memory. If the instrument is switched off then when power is restored the saved values of offsets will be automatically recalled and displayed. If the offset values are edited but not saved the edited values will be lost when the instrument is switched off.

The offset facility can be enabled or disabled using the *[Enable/Disable]* key. The state of the Enable/Disable function is stored in non-volatile memory if the *[Save Setting]* key is pressed. If the instrument power is turned off and then on, the stored condition of the Enable/Disable function is recalled.

The RF offset facility can be left by pressing *[EXIT]* to obtain the *RF Level Utility Menu* of Fig. B-2, or by pressing any of the keys underneath the display. If the offset facility is enabled and [SIG GEN] is pressed the main signal generator screen shown in Fig. B-4 is displayed. The display shows that in this example the RF offset facility is enabled and the value of the offset in use is +20 dB. For the set RF level of 0 dBm the signal generator output will be -20 dBm.

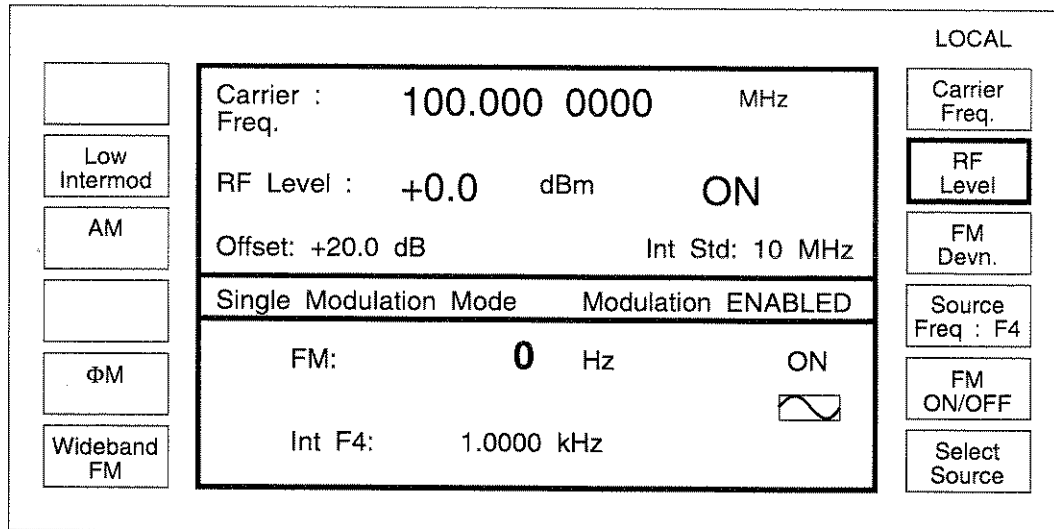

C0863

Fig. B-4 Main signal generator screen with RF offset enabled

RF PROFILES

If the [Profiles] key is selected from the menu shown in Fig. B-2 the display shown in Fig. B-5 is displayed. But note that the [Save Setting] and [Edit Profile] keys will only appear if the instrument is unlocked to Level 1.

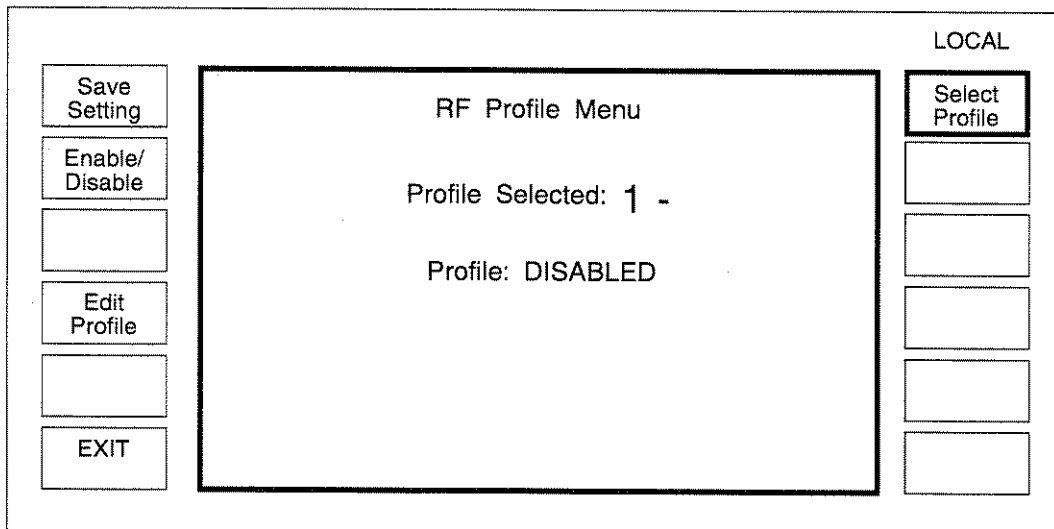

C0865

Fig. B-5 RF profile menu (shown unlocked to Level 1)

Up to 10 profiles may be generated and stored using this facility. The profiles are identified as Profile 0 to Profile 9. Each profile can have up to 100 frequencies at which the output level of the signal generator can be adjusted by up to ± 40 dB to compensate for the frequency response of an external device without altering the displayed RF level of the signal generator.

Creating a profile

An RF profile editor is provided to create or edit profiles. The instrument must be unlocked to Level 1 in order to use the editor. To use the profile editor press the *[Edit Profile]* key to give the display shown in Fig. B-6.

The screenshot shows the 'RF Profile Editor' interface. It features a central display area with the following text: 'Carrier: 10.0000 0000 MHz', 'Relative: +0.0 dB', 'Reference +0.0 dBm', 'Offset: +0.0 dB', and 'Cal. Points in Profile: 0'. The interface is framed by a border with several control buttons. On the left side, from top to bottom, are: 'Erase Profile', 'Store Profile', 'Recall Profile', 'Remove Point', an empty box, and 'EXIT'. On the right side, from top to bottom, are: 'LOCAL' (positioned above the buttons), 'Carrier Freq.', 'Profile Level', an empty box, 'Next Point', 'Previous Point', and another empty box. The text 'C0866' is located at the bottom right corner of the screen.

Fig. B-6 RF profile editor menu

The RF offset will only be displayed if an offset value has been selected and enabled. The signal generator's RF level setting is displayed as the reference level.

If the user wishes to edit an existing profile, pressing *[Recall Profile]* followed by the profile number (0 to 9) and the *[enter]* key will recall a profile into the editor. A profile can be erased by pressing *[Erase Profile]* followed by the profile number (0 to 9) and the *[enter]* key.

Profiles are constructed by entering the carrier frequency at which a correction is to be applied and then adjusting the RF output level until the required setting is obtained. The relative level shows how much the RF level has been adjusted from its nominal value. A positive value of relative level increases the RF output level.

To construct a profile first select the required carrier frequency using the *[Carrier Freq.]* key. The relative level at that frequency can then be adjusted by pressing *[Profile Level]*. The carrier frequency or profile level can be entered using the keyboard or the rotary control.

When the required value of level has been set up the point is saved using the *[Save Point]* key which appears in place of the *[Remove Point]* key. The *Cal Points in Profile* display shows how many points form the profile (a profile can have up to 100 points).

When a profile has been constructed (or is being entered) the points can be inspected by using the *[Next Point]* or *[Previous Point]* keys. To make the user aware that a limit has been reached i.e. the first or last point in a profile, the message *At Top Limit* or *At Bottom Limit* is displayed at the top of the screen. Points can be deleted using the *[Remove Point]* key. When *[Remove Point]* has been pressed, an additional key *[Restore Point]* appears. This allows a point which has been accidentally removed to be reinserted.

Points can be added to the profile in any frequency order so that if, for instance, it is found necessary to add a point between two existing points, then when the point is saved the software automatically re-orders the points into an ascending frequency order, and provides interpolation between these points.

Hint:

The rotary control provides a very useful means of editing or creating a profile. If the control is used to adjust carrier frequency while the power at a remote point is monitored, the control gives a good feel for where points should be inserted. The interpolation of the correction data between frequencies results in the most useful location for correction points to be either at or at either side of maximum or minimum values of power.

Note...

If a profile point is added at the same frequency as an existing point in that profile, the old profile level will be automatically overwritten by the new value.

Once two or more points have been entered in a profile the profile can be stored by pressing the *[Store Profile]* key followed by the profile number (0 to 9) and the [enter] key.

Enabling a profile

To enable or disable a profile first use the *[Select Profile]* key shown in Fig. B-5 and enter the profile number (0 to 9) to be used and terminate the entry using the [enter] key.

The *[Enable/Disable]* key can then be used to enable or disable the profile.

The profile facility can be set to be on or off when an instrument is switched on using the save setting facility. If the generator is unlocked to Level 1 pressing the *[Save Setting]* key on the *RF Profile Menu* of Fig. B-5 will result in the state of profile enable/disable flag and the selected profile number being stored in non-volatile memory. If the profile is enabled then at power on the generator will recall the profile and apply it to the RF output.

The *RF Profile Menu* can be left by using the *[EXIT]* key to obtain the *RF Level Utility Menu* of Fig. B-2 or by using the keys underneath the display. If the [SIG GEN] key is pressed to obtain the main signal generator screen, and the profile facility is enabled, the profile selected is displayed as shown in Fig. B-7. The correction value corresponding to the selected carrier frequency will be applied to the RF level.

Note...

Where the carrier frequency is set to a value less than the lowest profile frequency the value at the lowest profile will be used. Similarly if the set carrier frequency is higher than the highest profile frequency the value of the highest profile value will be used.

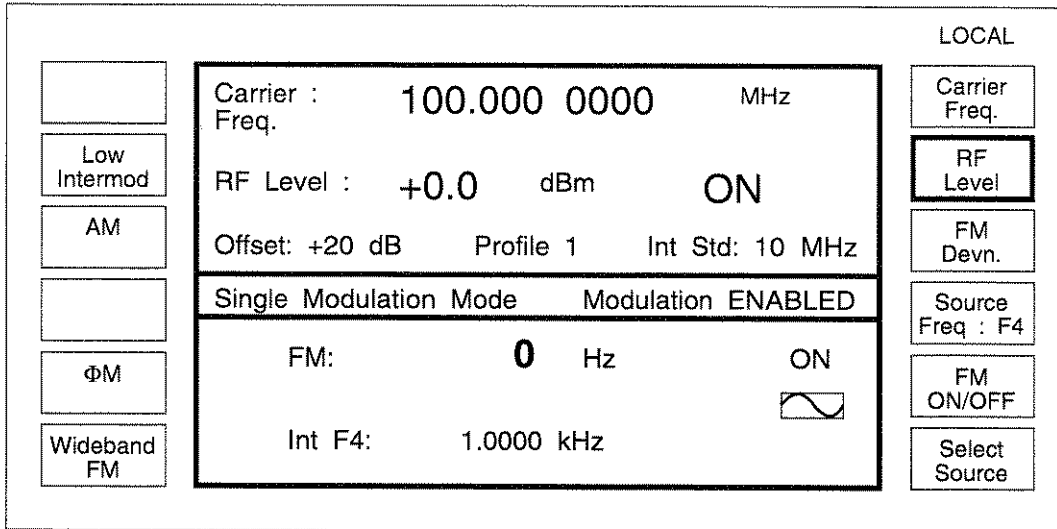

C0867

Fig. B-7 Main signal generator screen with RF offset and profiles enabled

TUTORIAL EXAMPLES FOR RF OFFSET AND PROFILES

Example 1: RF offset - compensating for a combiner

Problem:

An application requires the addition of two RF signals with a combiner as shown in Fig. B-8. The combiner has 6 dB insertion loss and it is desirable for the signal generators to display the signal level after the combiner.

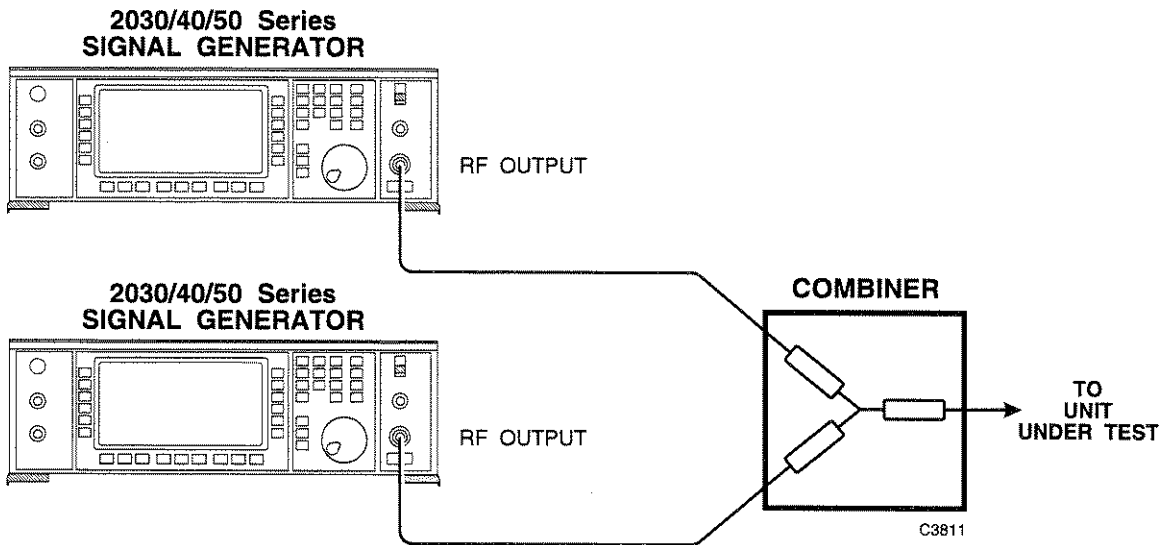

Fig. B-8 Two signal generator testing with a resistive combiner

Solution:

Use the RF offset facility. Set the RF output level (for example to +6 dBm). Then set *Offset 1* (see Fig. B-3) to -6 dB and enable the offset. The signal generators provide outputs of +6 dBm to compensate for the signal loss of the combiner whilst now displaying the signal level after the combiner (in the example 0 dBm) as required.

Note that the maximum displayed RF level will now be limited to +7 dBm since this represents +13 dBm at the RF output connector (unless the overrange facility is enabled).

If the save setting facility is used (Fig. B-3) the generator can be set so that every time it is switched on a -6 dB offset is applied.

Example 2: RF offset and profiles - compensating for an amplifier

Problem:

The signal generator is being used with an external amplifier having a nominal gain of 28 dB. The generator is being used over the frequency range 100 MHz to 500 MHz. Amplifier frequency response and cable losses result in the overall gain of the amplifier system varying between 25 dB and 31 dB. The signal generator is required to display the power at the output of the amplifier.

Solution:

Use both RF offset and RF profile. First use the RF offset facility to enter an offset value of 28 dB (i.e. the mid-point of 25 and 31 dB). Connect a power meter to the amplifier as shown in Fig. B-9 after making sure that the amplifier output is at a level which will not damage the power meter.

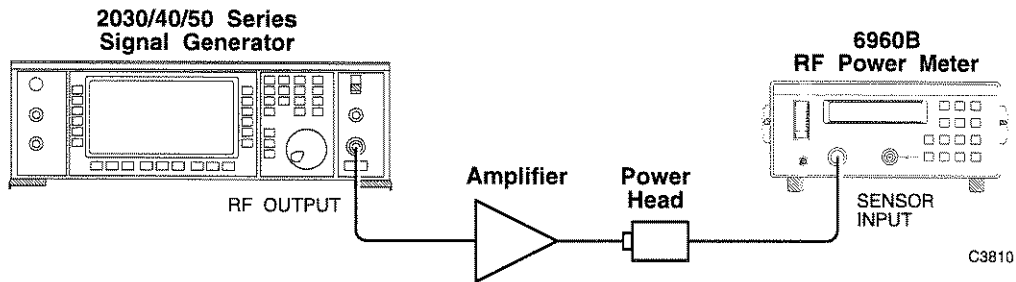

Fig. B-9 Using a signal generator with an external amplifier

A profile can now be added to reduce the frequency dependent RF level errors. With the signal generator level set at (for example) 0 dBm and unlocked to Level 1, select the *RF Profile Editor* shown in Fig. B-6.

Enter a carrier frequency of 100 MHz. Adjust the Profile Level until the power meter reads 0 dBm and then save the point. Repeat for carrier frequencies of 150 MHz, 200 MHz, 250 MHz, 300 MHz, 350 MHz, 400 MHz, 450 MHz and 500 MHz. The profile will now have 9 calibration points entered.

Use the [*Store Profile*] key to store as Profile 0. Exit to the *RF Profile Menu* and select and enable Profile 0.

Press the [SIG GEN] key to obtain the main *Sig Gen* menu. Use the rotary control to vary the carrier frequency between 100 MHz and 500 MHz and check that the power meter reading is acceptably close to 0 dBm. Extra points can be added to the profile if required to reduce errors at intermediate frequencies.

Note...

If the carrier frequency is set (in this example) below 100 MHz or above 500 MHz the error message *Carrier Outside Profile* will be displayed. The profile value at 100 MHz will be applied to the RF output level for frequencies below 100 MHz. Similarly the profile value at 500 MHz will be applied to the RF output level for frequencies above 500 MHz.

SEQUENCE SWEEP

The sequence sweep facility allows sweeps to be defined and generated containing up to 10 segments with independent parameters.

The sweep segments differ from the normal sweep facility on 2050 Series Signal Generators in that the step size is defined rather than the number of steps in a sweep. Each sweep segment can have a different RF level, step size and step time as well as independent start and stop frequencies. A sweep similar to that shown in Fig. B-10 can therefore be generated.

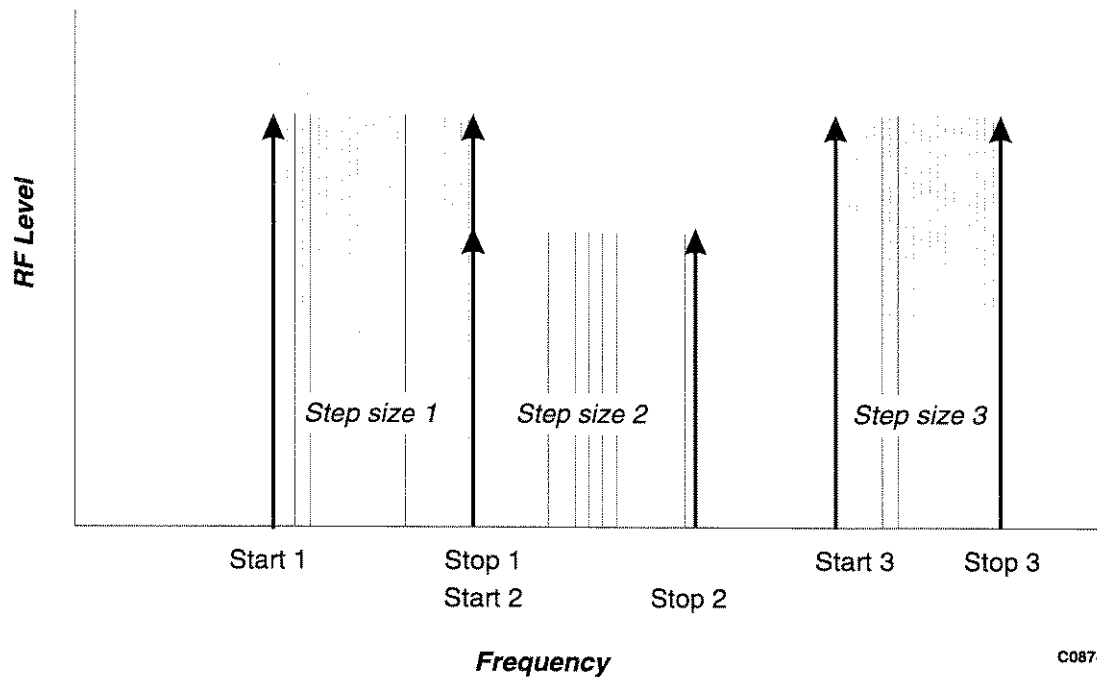
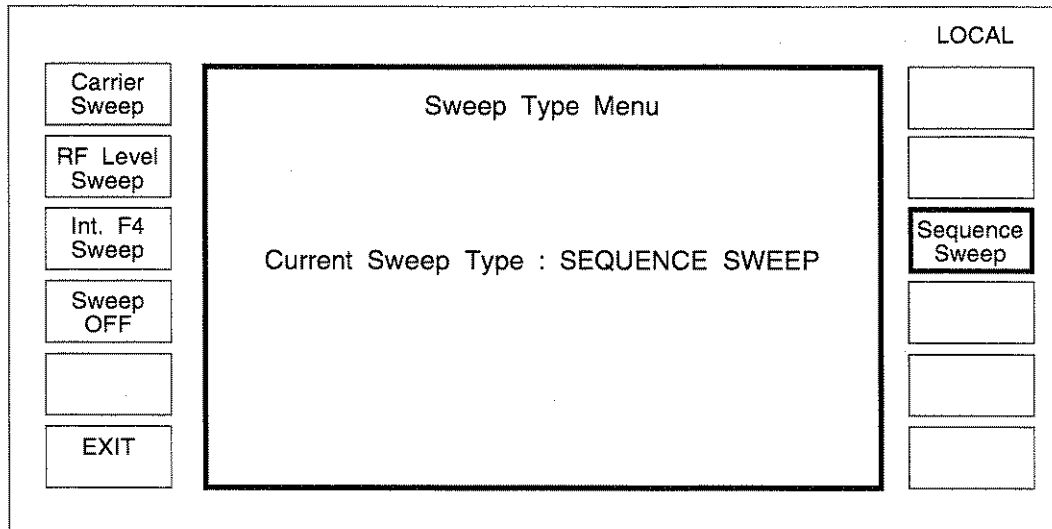

Fig. B-10 Example for a segmented sweep

The segments can be executed in any order. The RF Profile and RF Offset facility can be enabled to correct for the use of external amplifiers and cables.

Selecting a sequence sweep

To enter the Sequence Sweep mode press the [SWEEP] key to obtain the main sweep generator menu. If the last used sweep is not a sequenced sweep press [Sweep Type] to obtain the display shown in Fig. B-11, press [Sweep Sequence] and use the [EXIT] or [SWEEP] key to return to the Sweep Sequence selection menu shown in Fig. B-12.



The image shows a screen titled "Sweep Type Menu". In the center, it displays "Current Sweep Type : SEQUENCE SWEEP". On the left side, there is a vertical column of buttons: "Carrier Sweep", "RF Level Sweep", "Int. F4 Sweep", "Sweep OFF", an empty button, and "EXIT". On the right side, there is a vertical column of buttons: "LOCAL", an empty button, "Sequence Sweep" (which is highlighted with a thick border), an empty button, an empty button, and an empty button.

C0858

Fig. B-11 Sweep type menu

Note...

RF profiles cannot be applied to the normal carrier sweep provided on the generator. If RF profiles are enabled the [Carrier Sweep] key in Fig. B-11 will not be displayed.

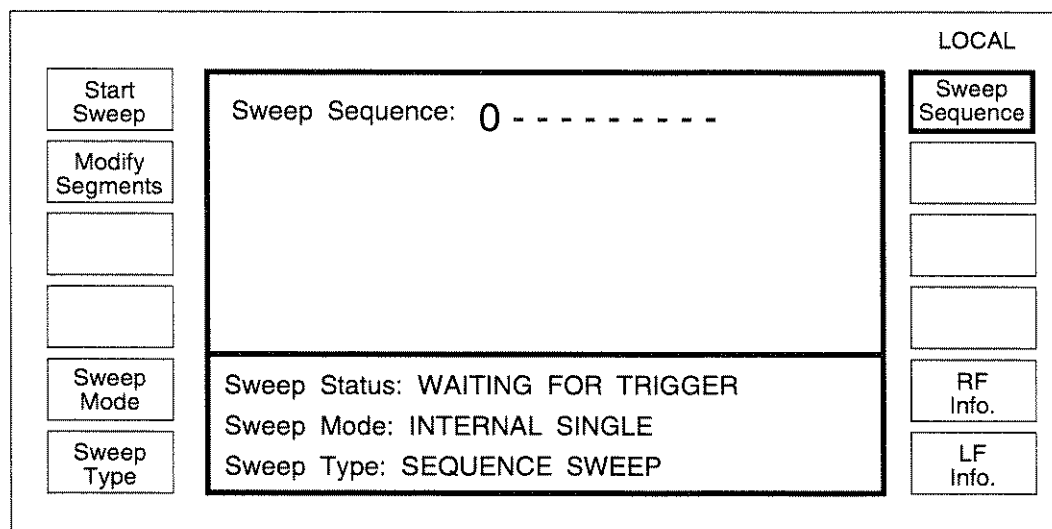

The image shows a screen titled "Sweep Sequence Selection Menu". In the center, it displays "Sweep Sequence: 0 - - - - -". Below this, it shows "Sweep Status: WAITING FOR TRIGGER", "Sweep Mode: INTERNAL SINGLE", and "Sweep Type: SEQUENCE SWEEP". On the left side, there is a vertical column of buttons: "Start Sweep", "Modify Segments", an empty button, an empty button, "Sweep Mode", and "Sweep Type". On the right side, there is a vertical column of buttons: "LOCAL", "Sweep Sequence" (highlighted with a thick border), an empty button, an empty button, an empty button, "RF Info.", and "LF Info.".

C0859

Fig. B-12 Sweep sequence selection menu

Modifying segments

Sequenced sweeps are defined by a series of segments each of which has independent settings. The segments can be constructed from the menu shown in Fig. B-13 called up by pressing the *[Modify Segments]* key.

		LOCAL
	Segment Number: 0 -	Segment Number
Next Segment	Start Freq: 10.0000 kHz	Start Freq.
Previous Segment	Stop Freq: 100.0000 kHz	Stop Freq.
	RF Level : +0.0 dBm	RF Level
	Step Size : 100.0 Hz	Step Size
EXIT	Step Time: 20 ms Offset: +20.0 dB Profile 1	Step Time

Fig. B-13 Sweep segment editor

C0856

Up to 10 segments can be defined as Segments 0 to 9. If an existing segment is to be inspected (or a segment similar to an existing one is required) the segment can be recalled by pressing *[Segment Number]* followed by the segment number (0 to 9) and the *[enter]* key. Pressing *[Next Segment]* or *[Previous Segment]* will increment or decrement through the segments. For each segment the *[Start Freq.]*, *[Stop Freq.]*, *[RF Level]*, *[Step Size]* and *[Step Time]* keys can be used to define the segment parameters.

Once the user has defined the required segments in a sweep pressing the *[EXIT]* key returns the user to the *Sweep Sequence Selection Menu* shown in Fig. B-12.

Note...

The segment settings are not automatically stored in the non-volatile memory. To store the settings press the *[MEM]* key. If the memory recall menu is displayed press *[Memory Store]*. Press *[Sweep Store]* followed by the sweep store number (0 to 19) and the *[enter]* key.

Entering a sweep sequence

From the sweep menu in Fig. B-12 a sweep sequence can be defined by pressing *[Sweep Sequence]* followed by the segment numbers (0 to 9) in the order that they are required to be generated. A minimum of one and a maximum of 10 segments is allowed.

Sweep mode

The *[Sweep Mode]* key can be used to set the sweep to be externally or internally triggered and to be in continuous or single shot mode.

Note...

This is identical to the trigger system used in the other sweep modes.

Starting to sweep

To start a sweep press the *[Start Sweep]* key on the Sweep Sequence selection menu (Fig. B-12). The signal generator will start sweeping and display the current frequency, RF level, step time and the segment number it is currently in. If the sweep has been set to go through a number of segments at different levels the display is updated to show the change of setting.

Before the start of a sweep the RF or LF settings of the generator can be inspected by pressing the *[RF Info.]* or *[LF Info.]* keys.

When a sweep is in progress the sweep can be stopped at any point using the *[Stop Sweep]* key and a display similar to Fig. B-14 will be shown. The carrier frequency and RF level can be varied by using the rotary control.

		LOCAL
Continue Sweep	Carrier: 12.010000 MHz	Carrier Freq.
Reset Sweep	RF Level: +0.0 dBm ON	RF Level
Transfer Carrier	Offset: +20.0 dB Profile 1	
Transfer RF Level	Step Time: 20 ms	
	Sweep Station: PAUSED IN SEGMENT 0	
	Sweep Mode: INTERNAL SINGLE	
	Sweep Type: SEQUENCE SWEEP	

C0857

Fig. B-14 Sweep menu display with the sweep halted

Pressing *[Continue Sweep]* will result in the sweep restarting from the same frequency and level as it was stopped at.

Pressing *[Reset Sweep]* will return the sweep to the starting point.

Pressing *[Transfer Carrier]* and/or *[Transfer RF Level]* will transfer the current setting to the main signal generator carrier and RF level settings (obtained by pressing *[SIG GEN]*).

TUTORIAL EXAMPLES FOR SEQUENCE SWEEP

Example 1: System immunity test

Problem:

A digitally stepped signal is required to test the immunity of a system to RF signals applied at harmonics of the internal clock frequencies of a unit under test. The test requires that the first 20 harmonics are checked and that the signal is swept 10 kHz either side of the nominal clock frequency. The unit under test contains clock frequencies of 8 MHz (for the microprocessor) and 10 MHz.

Solution:

Set the signal generator to provide a frequency modulated signal from the internal triangle source at a rate of 20 Hz and a deviation of 10 kHz.

Use the segmented sweep facility to set up Segment Number 0 to start at 8 MHz with a step size of 8 MHz, a step time of 100 ms and a stop frequency of 160 MHz.

Set up Segment Number 1 to start at 10 MHz with a step size of 10 MHz, a step time of 100 ms and a stop frequency of 200 MHz.

Create a sequence sweep using Segment Number 0 and Segment Number 1. Set the sweep trigger to continuous.

If the sweep is now started it will generate a stepped sweep alternating between harmonics of the 8 MHz and 10 MHz clock and the FM signal will sweep the frequency over a range of ± 10 kHz. The FM signal will nominally sweep linearly over the 10 kHz range twice in each direction on each step since the modulation rate is 20 Hz and the step time is 100 ms.

Example 2: Blocking performance test

A radio is being tested for blocking performance. The radio is tuned to 356.55 MHz and uses 12.5 kHz channel spacing. A sweep is required which extends from 10 MHz below the wanted channel to 10 MHz above the wanted channel but excludes the adjacent and next adjacent channels. The RF level is required to be set to -37 dBm during the sweep.

Solution:

Set Segment Number 0 to start at 346.55 MHz, stop at 356.5125 MHz with a step size of 12.5 kHz and a step time to 100 ms to allow enough time for the radio to respond. The RF level should be set to -37 dBm.

Set Segment Number 1 to start at 356.5875 MHz, stop at 366.55 MHz with a step size of 12.5 kHz, a step time of 100 ms and an RF level of -37 dBm.

Set up Segment Number 2 with a start frequency of 356.5125 MHz, a stop frequency of 356.5875 MHz at step size of 100 kHz and a step time of 100 ms. Set the RF level to -144 dBm.

Set up a sequence sweep using Segment Numbers 0, 2 and 1. The signal generator will now sweep from 346.55 MHz to 356.5125 MHz at -37 dBm, then turn the carrier off, step to 356.5875 MHz, turn the carrier on and then sweep to 366.55 MHz as required.

COMPLEX SWEEPS

RF profiles, offset and sequence sweep

The sequence sweep can be combined with the RF profile and RF offset facility to provide a swept signal source where the signal generator displays the RF level at the output of an external frequency dependent amplifier or attenuator.

To set up a sweep of this type use the required sequence sweep, and RF profile and RF offset can be set up as previously described. If the required RF offset and RF profile are then enabled and the sequence sweep selected a complex sweep incorporating all these facilities can be generated.

Suppressing attenuator changes

In addition to being used with RF profiles and RF offsets, sequence sweeps can also be used in conjunction with Extended Hysteresis. Sweeps generated with the Extended Hysteresis mode enabled, will use the modified electronic control facility to apply the RF profiles and to vary the RF output level. Provided the required level does not exceed the Extended Hysteresis electronic control range the mechanically actuated attenuator will not be operated.

Note...

When the -HYST flag is displayed the RF level of the generator is not as accurate as normal modes of operation.

TUTORIAL EXAMPLE FOR IMMUNITY TESTING

Example: Immunity testing in a GTEM cell

Problem:

A device is to be tested to check its immunity to electro-magnetic fields using a GTEM cell. The test requires that the device is tested for field strengths of 10 V/m at frequencies from 1 MHz to 100 MHz and 3 V/m from 100 MHz to 400 MHz. The tests call for checks to be made at 10 kHz intervals from 1 MHz to 30 MHz, 12.5 kHz from 30 MHz to 100 MHz and 100 kHz intervals from 100 MHz to 400 MHz. The GTEM system requires a nominal signal of -10 dBm to drive an amplifier that provides a 10 V/m field strength in the cell.

Solution:

The test requires a combination of the sequence sweep, RF offset and RF profile facilities. In this case the "RF Levels" required at the remote point are field strengths of 10 V/m and 3 V/m. The RF offset facility can be used to convert a nominal signal of -10 dBm to a displayed 10 V PD by using an offset of +43 dB (10 V PD is approximately +33 dBm).

Use a field probe to check the field strength in the GTEM cell. With the generator set to 10 V PD use the RF profile facility to obtain a 10 V/m reading on the field probe for frequencies between 1 MHz and 400 MHz. While creating the RF profile remember that the signal generator software interpolates between profile points so points need to be entered only when the profile slope changes. Store the RF profile produced and check that the field strength is substantially constant as the frequency is changed.

Note...

In this example it is assumed that the RF amplifier is capable of generating a field of 10 V/m at all frequencies and that the amplifier is working in the linear region.

Set up a sequence sweep using segments providing the following characteristics:-

	START	STOP	STEP SIZE	RF LEVEL	STEP TIME
Segment Number 0	1 MHz	30 MHz	10 kHz	10 V PD	100 ms
Segment Number 1	30 MHz	100 MHz	12.5 kHz	10 V PD	100 ms
Segment Number 2	100 MHz	400 MHz	100 kHz	3 V PD	100 ms

Select a sequence sweep using Segment Numbers 0, 1 and 2. With the RF profile and RF offset enabled and the device under test inserted in the GTEM in place of the field probe a swept test can now be undertaken.

The test can be repeated at higher or lower field strength by simply redefining the RF level in the sweep segments.

SQUARE WAVE MODULATION

Generators supplied with Option 008 fitted can generate square wave modulation in addition to the standard sine and triangle waveforms. Square wave modulation can be selected from the main signal generator menu with the modulation set to internal by pressing [*Select Source*] to obtain the *Internal Source Selection Menu* and then pressing [*Square Wave*] to select the square wave modulation source.

The rise and fall times of the square wave are shaped to ensure that minimal overshoot is obtained for AM with frequencies up to at least 2 kHz.

GPIB OPERATION

The following GPIB mnemonics are used to control the RF profile and complex sweep option in addition to those described in Chapter 3-2.

Segmented sweeps

Segmented sweep is a new sweep type which enables the user to set up segments of carrier sweep and store these away in non-volatile memory for future use. Each segment will consist of a START and STOP frequency, RF LEVEL, STEP SIZE and STEP TIME.

A complex sweep can be set up by specifying a sequence of these segments; on completion of sweeping one segment the sweep will jump to the start of the next segment and continue sweeping.

The following GPIB commands are used to provide GPIB control of the segmented sweep.

SWEEP [not used alone]
:TYPE <character program data>
Select type of sweep

Data type: SEQ (Segmented Sweep)
Allowed Suffices: None
Default Suffix: None

SWEEP? Responds with information on Sweep Type and Sweep Mode status as follows:

:SWEEP:TYPE <type>;MODE <mode>

Example: :SWEEP:TYPE SEQ;MODE SNGL

SWEEP [not used alone]
:SEQUENCE <string program data>
Select Segmented Sweep Sequence

Data type: String of Segment numbers (0-9) with up to 10 characters between string delimiters (e.g. "1238976" or '987665')
Allowed Suffices: None
Default Suffix: None

SWEEP:SEQUENCE? Responds with currently selected Sequence as follows:

:SWEEP:SEQUENCE <string program data>

Example: :SWEEP:SEQUENCE "5675676543"

SWEEP [not used alone]

:SEG0 [not used alone]

↓

:SEG9

:<cmd> Select a Segment to edit where <cmd> is replaced by one of the following:

:START Select start frequency

:STOP Select stop frequency

:SIZE Select step size

Data type: Decimal Numeric Program Data

Allowed Suffixes: GHZ, MHZ, KHZ, HZ

Default Suffix: HZ

:RFLV Select RF Level

Data type: Decimal Numeric Program Data

Allowed Suffixes: DBM, DBV, DBMV, DBUV, V, MV, UV

Default Suffix: DBM unless changed by UNITS command

:TIME Select step time

Data type: Decimal Numeric Program Data

Allowed Suffixes: MS

Default Suffix: MS

SWEEP:SEG0?

↓

:SEG9? Responds with parameter settings for segment number specified (0-9) as follows:

:SWEEP:SEG<nrf>:START <nrf>;STOP <nrf>;
RFLV <nrf>;SIZE <nrf>;TIME <nrf>

Example: **:SWEEP:SEG2:START 125000000.0; STOP 1750000000.0;**
RFLV -32.4; SIZE 50000000.0; TIME 20

:XFER:CW Transfer Paused Carrier value to main parameter

Data type: None

Allowed Suffixes: None

Default Suffix: None

:XFER:RFLV Transfer Paused RF Level value to main parameter

Data type: None

Allowed Suffixes: None

Default Suffix: None

RF profiles

Used for specifying a level profile over a frequency range. Consists of relative offsets, from a predefined reference level, at user defined frequencies. Linear interpolation is used to calculate the level between frequency points. Up to 10 profiles can be stored away in non-volatile memory for future use.

These profiles can be used in conjunction with segmented sweeps as well as in NORMAL instrument mode, but not with ordinary frequency carrier sweeps.

The following GPIB commands are used to provide GPIB control of the RF profiles.

PROFILE	[not used alone]
:STATUS	[not used alone]
:NUM	Select Profile (0-9)
Data type:	Decimal Numeric Program Data
Allowed Suffices:	None
Default Suffix:	None
:ENABLE	Enable Selected Profile
:DISABLE	Disable Selected Profile
:SAVE	Store profile setting and status in memory
Data type:	None
Allowed Suffices:	None
Default Suffix:	None

PROFILE:STATUS? Responds with Selected Profile number (0-9) and Status as follows:

:PROFILE:STATUS:NUM <nr1>;<status>

Example: `:PROFILE:STATUS:NUM 4;ENABLE`

To edit a profile, first set the instrument mode to PROFILE

IMODE	Select instrument mode
Data type:	Character program data (NORMAL, SWEEPER or PROFILE)
Allowed Suffices:	None
Default Suffix:	None

Example: `IMODE PROFILE`

PROFILE [not used alone]

:EDIT [not used alone]

:CFRQ Set Carrier Frequency

Data type: Decimal Numeric Program Data
 Allowed Suffices: GHZ, MHZ, KHZ, HZ
 Default Suffix: HZ

:OFFS Set Relative Offset

Data type: Decimal Numeric Program Data
 Allowed Suffices: dB
 Default Suffix: dB

:SAVE Save profile point

Data type: None
 Allowed Suffices: None
 Default Suffix: None

:REMOVE Remove a profile point (1 - Number of Points in profile)

Data type: Decimal Numeric Program Data
 Allowed Suffices: None
 Default Suffix: None

:POINT Select a profile point (1 - Number of Points in profile)

Data type: Decimal Numeric Program Data
 Allowed Suffices: None
 Default Suffix: None

:ERASE Clear profile in memory (0-9)

:STO Store profile in memory (0-9)

:RCL Recall profile from memory (0-9)

Data type: Decimal Numeric Program Data
 Allowed Suffices: None
 Default Suffix: None

PROFILE:EDIT:POINT? Responds with Carrier Frequency and Relative Offset for the point requested as follows:

:PROFILE:EDIT:CFRQ <nrf>;OFFS <nrf>

Data type: Decimal Numeric Program Data
 Allowed Suffices: None
 Default Suffix: None

Example: **:PROFILE:EDIT:CFRQ 1000000.0;OFFS -9.9**

PROFILE:EDIT?

Responds with the Number of Points in Profile Editor as follows:

<number of points>

Example: 20

RF offsets

The GPIB commands for RF LEVEL OFFSETS are as follows:

RFLV

:OFFS

[not used alone]

:NUM

Select RF Offset (1-5)

Data type: Decimal Numeric Program Data

Allowed Suffices: None

Default Suffix: None

:VALUE

Set current RF Offset value

Data type: Decimal Numeric Program Data

Allowed Suffices: dB

Default Suffix: dB

:ENABLE

Enable Selected RF Offset

:DISABLE

Disable Selected RF Offset

:SAVE

Store RF Offsets and status in non-volatile memory

Data type: None

Allowed Suffices: None

Default Suffix: None

RFLV:OFFS?

Responds with RF Offset Selected, its Value and its Status as follows:

:RFLV:OFFS:NUM <nr1>;VALUE <nrf>;<status>

Example: :RFLV:OFFS:NUM 3;VALUE -40.0;ENABLE



INDEX

A

Accessories 1-20
Adjusting the display 3-1-73
ALC 3-1-57
Alternative tone standards 3-1-61, 3-1-64
Amplitude modulation 3-1-54
Analog modulation mode 3-1-53
Auxiliary I/O connector 2-7
Avionic/Satellite systems selection 3-1-24
Avionics option A-1

B

Battery replacement 2-11
Beryllia v

C

Calibration 1-6, 3-1-78
Calibration due date 5-1-47
Carrier frequency 3-1-13
Carrier frequency accuracy 5-1-8
Carrier frequency offset 5-1-22
Carrier phase adjustment 3-1-75
Cellular systems selection 3-1-21
Choice of units 3-1-13
Class I power cords (3-core) 2-2
Cleaning 2-11
Commands and queries 3-2-64
Connecting to supply 2-5
Continuous tone signalling 3-1-60
Control knob 3-1-7, 3-1-12
Conventions 3-1-6
Cordless systems selection 3-1-25

D

Data/timing 3-1-32
Declaration of conformity 1-21
Default settings 3-2-8
Device dependent commands 3-2-8
Digital data mapping 3-1-34
Digital modulation mode 3-1-17, 5-1-29
Display 1-3
Display adjust 3-1-73
Display blanking 3-1-79
Displaying shifts 3-1-66
DTMF 3-1-63

E

Elapsed time 3-1-79
Electrical hazards iv

Electronic attenuator Appendix C
Envelope control 5-1-43
Error handling 3-1-94
Extended hysteresis 3-1-81
External AM 5-1-17
External envelope 3-1-43, 3-1-50
External FM 5-1-20
External modulation 5-1-13
External source selection 3-1-57
External trigger 3-1-74

F

Factory default settings 3-2-87, 3-2-8
Filter selection 3-1-29
Fire hazards v
First time use 3-1-11
Frequency hopping 3-1-91
Frequency modulation 3-1-54
Frequency standard selection 3-1-75
Front panel 3-1-6
FSK 3-1-40
FSK selection 3-1-28
Fuses 2-5, iv

G

General purpose interface bus (GPIB) 2-6
Good-in checks 2-5
GMSK selection 3-1-26
GPIB address 3-1-75
GPIB functions 3-2-2
GPIB mnemonics
 AM 3-2-31
 AM? 3-2-31
 BACKL 3-2-51
 BLANK 3-2-51
 CCR? 3-2-64
 CFRQ, 3-2-10
 CFRQ? 3-2-10
 *CLS 3-2-7, 3-2-64
 CSE 3-2-64
 CSE? 3-2-64
 CSR? 3-2-59, 3-2-64
 CTONES 3-2-36
 CTONES? 3-2-36
 DATE? 3-2-52
 DCF MNL 3-2-32
 DEFTRG 3-2-52
 ELAPSED? 3-2-52
 ERASE 3-2-44
 ERROR? 3-2-52

contd./...

G GPIB mnemonics (*continued*)

*ESE 3-2-7, 3-2-57, 3-2-64
*ESE? 3-2-7, 3-2-57, 3-2-64
*ESR? 3-2-7, 3-2-57, 3-2-64
EXTTRG 3-2-53
FM 3-2-29
FM? 3-2-29
FSTD 3-2-51
FSTD? 3-2-51
HCR? 3-2-58, 3-2-64
HOPSEQ 3-2-50
HOPSEQ? 3-2-50
HSE 3-2-58
HSE? 3-2-58, 3-2-64
HSR? 3-2-58, 3-2-64
*IDN? 3-2-6
IMODE 3-2-10, 3-2-45, 3-2-51
INTF1 3-2-34
INTF1? 3-2-35
KLOCK 3-2-53
KUNLOCK 3-2-53
LF 3-2-41
LF? 3-2-41
LFGF 3-2-42
LFGF? 3-2-42
LFGL 3-2-43
LFGL? 3-2-43
MOD 3-2-15
MOD? 3-2-15
MODE 3-2-14, 3-2-16
MODE? 3-2-14, 3-2-16
*OPC 3-2-6
*OPC? 3-2-6
*OPER? 3-2-52
*OPT? 3-2-6
PM 3-2-30
PM? 3-2-30
*PUD 3-2-7
*PUD? 3-2-7
PULSE 3-2-33
PULSE? 3-2-33
RCL 3-2-44
RFLV 3-2-11
RFLV? 3-2-12, 3-2-13
RPPR 3-2-51
*RST 3-2-6
SCR? 3-2-60, 3-2-64
SEQT 3-2-37
SEQT? 3-2-39
*SRE 3-2-7, 3-2-62, 3-2-63, 3-2-64
*SRE? 3-2-7, 3-2-62, 3-2-63, 3-2-64
SSE 3-2-60, 3-2-64
SSE? 3-2-60, 3-2-64
SSR? 3-2-60, 3-2-64
*STB? 3-2-7, 3-2-62, 3-2-64
STO 3-2-44
SWEEP 3-2-45, 3-2-48, 3-2-49
SWEEP? 3-2-46, 3-2-49

TIME? 3-2-52
*TRG 3-2-6
*TST? 3-2-6
*WAI 3-2-6
WBFM 3-2-32
WBFM? 3-2-32

H

Hardware information 3-1-74

I

IEEE 488.2 3-2-2
IEEE to IEC conversion 2-7
IF output 5-1-46
Incrementing 3-1-66
Installation requirements 2-2
Interface bus connection 2-7
Internal AM depth and distortion 5-1-15
Internal FM deviation 5-1-18
Internal phase modulation 5-1-23
Internal source selection 3-1-55
IQ input impedance selection 3-1-49
IQ modulator errors 3-1-44

K

Keyboard locking 3-1-79

L

Last complete check date 5-1-47
Latch data 3-1-78
LF generator 3-1-86
LF level units 3-1-80
LF monitor 3-1-85
LF operation 3-1-85
LF output 3-1-85, 5-1-11
LF phase 3-1-56
Lithium batteries v
Locking and unlocking 3-1-79
Low frequency operation 3-1-85
Low intermodulation 3-1-59

M

Main features 1-2
Markers 3-1-69
Memory 3-1-87
 Recall 3-1-87
 Store 3-1-89
Menus 3-1-9
Mixer selection 3-1-42, 3-1-49
Modulation 3-1-12, 3-1-14
Modulation ALC 3-1-57
Modulation fading 3-1-43, 3-1-51
Modulation modes 3-1-14
Modulation oscillator 5-1-9

N

Number of steps 3-1-69

O

Option 001 Second LF oscillator Appendix A
Option 002 Pulse modulation Appendix B
Option 006 Avionics Annex A
Option 008 RF profiles and complex sweep Annex B
Option 012 Electronic attenuator Appendix C
Optional accessories 1-20
Options 1-6
Output level 3-1-13

P

Paging systems selection 3-1-21
Patent protection iii
Performance data 1-8
Phase modulation 3-1-54
PMR systems selection 3-1-23
Power up options 3-1-80
Program data 3-1-5
Program messages 3-2-4
Programming 3-2-4
Protection 1-6
PSK 3-1-34
PSK selection 3-1-27
Pulse modulation 3-1-58
Pulse modulation option Appendix B
Putting into storage 2-11

Q

QAM 3-1-38
QAM selection 3-1-27

R

Rack mounting 2-9
Real time clock battery 5-1-47
Rear panel 3-1-8
Recommended test equipment 5-1-3
Remote/local operation 3-2-5
Removal of covers iv
Reverse power protection 3-1-13

RF level units 3-1-80
RF level utility 3-1-81
RF output 5-1-4
RF profiles and complex sweep Annex B
Routine maintenance 2-9

S

Safety testing (routine) 2-9
Second modulation oscillator Appendix A
Self-calibration 3-1-17, 3-1-47
Sequential calling tones 3-1-61
Software information 3-1-74
Source selection - external 3-1-57
Source selection - internal 3-1-55
Spectral purity 5-1-25
Status byte 3-2-54
Step time 3-1-69
Store erase 3-1-91
Sweep 3-1-67, 3-1-70

T

Technical description 4-1
Test tones utility 3-1-31
Time and date 3-1-79
Time offset QPSK selection 3-1-27
Tone selection 3-1-60, 3-1-62
Tone standard editing 3-1-61, 3-1-65

U

Utilities 3-1-73
User defined systems selection 3-1-20

V

Vector modulation mode 3-1-47, 5-1-40
Ventilation 2-2
Versions 1-20
Voltage selector 2-5

W

Wideband frequency modulation 3-1-54

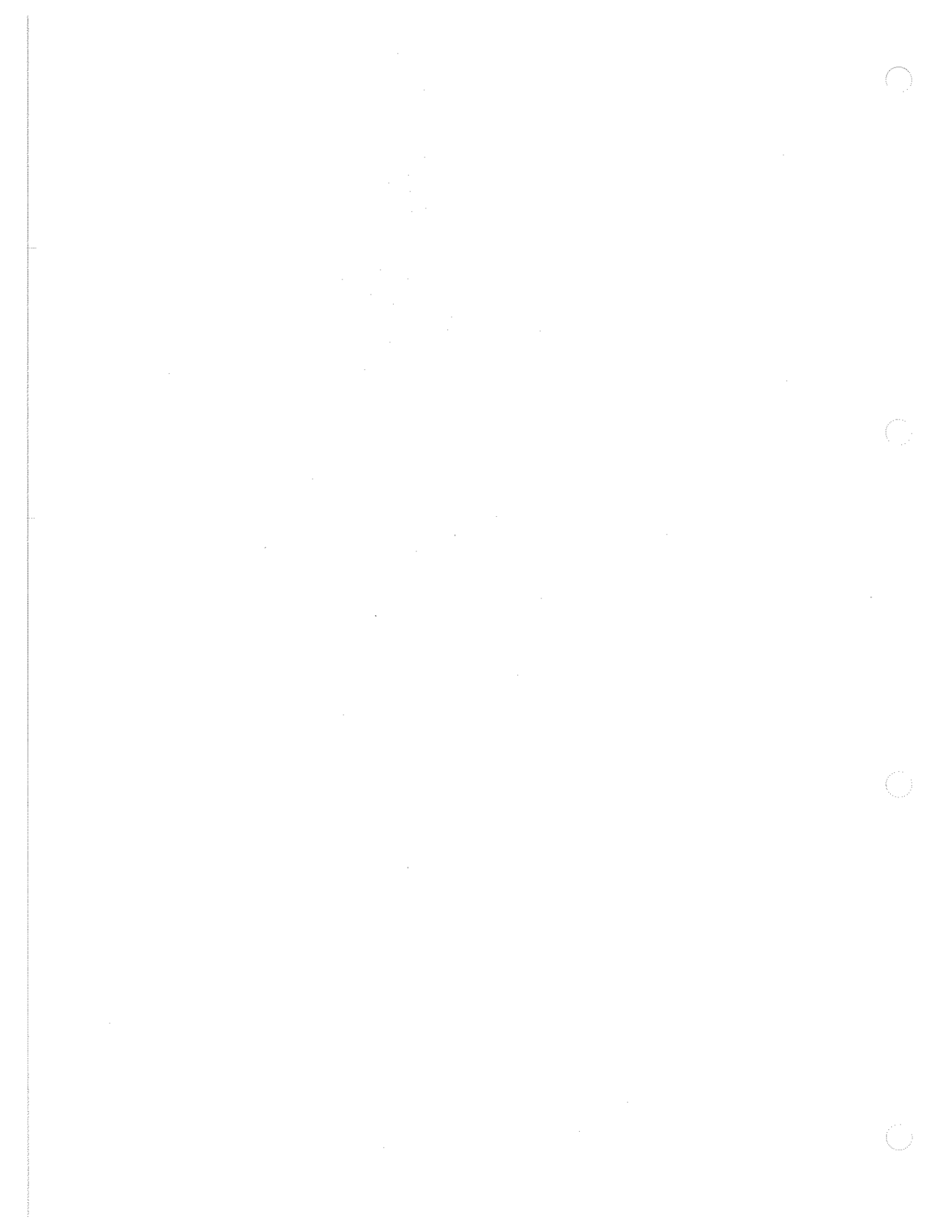

IFR LTD

SOFTWARE WARRANTY STATEMENT

Definitions

Any software provided by IFR Ltd is supplied subject to the terms of IFR's Software Licence. This is printed on the reverse of our Quotations, will be found with our shrink-wrap Products and is available on request. Software is defined in the Licence as "Licensed Software" and can be further sub-divided as follows:

"Embedded Software" means Licensed Software that forms part of the Equipment supplied by IFR and without which the Equipment cannot function.

"Add-In Application Software" means Licensed Software that may be loaded separately from time to time into the Equipment to improve or modify its functionality.

"Computer Application Software" means Licensed Software supplied to run on a standard PC or workstation.

Warranty

- 1 IFR certifies that the Licensed Software supplied by IFR will at the time of delivery function substantially in accordance with the applicable Software Product Descriptions, Data Sheets or Product Specifications published by IFR.
- 2 Unless you have purchased or been provided with extended warranty for Embedded Software the warranty period from date of delivery in respect of each type of Licensed Software is
 - (i) Embedded Software
12 months
 - (ii) Add-In Application Software
90 days
 - (iii) Computer Application Software
90 days

- 3 If during the appropriate Warranty Period the Licensed Software does not conform substantially to the above Software Product Descriptions, Data Sheets or Product Specifications, IFR will provide
 - a) In the case of Embedded Software and at IFR's discretion either a fix for the problem or an effective and efficient work around.
 - b) In the case of Add-In Application Software and Computer Application Software and at IFR's discretion replacement of the software or a fix for the problem or an effective and efficient work around.

IFR does not warrant that the operation of any software will be uninterrupted or error free.

Limitation of Warranty

The above Warranty does not apply to:

- (i) Defects resulting from software not supplied by IFR, from unauthorised modification or misuse or from operation outside of the specification.
- (ii) Third party produced Proprietary Software which IFR may deliver with its products, in such case the third party Software Licence Agreement including its warranty terms shall apply.

Exclusive Remedies

The remedies offered above are your sole and exclusive remedies and to the extent permitted by applicable law are in lieu of any implied conditions, guarantees or warranties whatsoever and whether statutory or otherwise as to the software all of which are hereby expressly excluded.



Regional Offices

The international country codes in telephone and fax numbers are shown in square brackets [] whilst the national area codes are identified by round brackets ().

UNITED KINGDOM

Marconi Instruments Ltd
Longacres House
Norton Green Road
STEVENAGE
Hertfordshire SG1 2BA
United Kingdom
Telephone: [+44] (1438) 742200
Fax: [+44] (1438) 727601
Telex: 23350 MARCON G

AUSTRALIA

Marconi Instruments (Pty) Ltd
Unit 1
38 South Street
Rydalmere,
NEW SOUTH WALES, 2116
Australia
Telephone: [+61] (2) 638 0800
Fax: [+61] (2) 638 3131

FRANCE

Marconi Instruments SA
18 Rue du Plessis-Briard
"Le Canal"
Courcouronnes
91023 EVRY CEDEX
France
Telephone: [+33] (1) 60 79 96 00
Fax: [+33] (1) 60 77 69 22

HONG KONG

Marconi Instruments International Ltd.
Room 702-703,
CC Wu Building
302-308 Hennessy Road
WANCHAI
Hong Kong
Telephone: [+852] 2832 7988
Fax: [+852] 2834 5364
Email: mihk@asiansources.com

UK SERVICE DIVISION

Marconi Instruments Ltd
The Airport
LUTON
Bedfordshire LU2 9NS
United Kingdom
Telephone: [+44] (1582) 33866
Fax: [+44] (1582) 417573

GERMANY

Marconi Messtechnik GmbH
Landsberger Strasse 65
D-82110 GERMERING
Germany
Telephone: [+49] (89) 84 9360
Fax: [+49] (89) 84 19142
Telex: 5212642 MMMC D

NETHERLANDS

Marconi Instrumenten
Van Limburg Stirumlaan 4
5037 SK TILBURG
Postbus 645
5000 AP TILBURG
Netherlands
Telephone: [+31] (13) 463 95 40
Fax: [+31] (13) 4639663

SINGAPORE

Marconi Instruments International Ltd
ASEAN Regional Centre
GEC Building
3 Tai Seng Drive
SINGAPORE 535216
Telephone: [+65] 381 1470
Fax: [+65] 281 0113
Telex: 36370 GECSRSRS

SPAIN

Marconi Instrumentos S.A.
Europa Empresarial
C/Rozabella, No. 6
Edif. Paris, Planta Baja, Oficina 1
28230 LAS ROZAS
Madrid, Spain
Telephone: [+34] (1) 640 11 34
Fax: [+34] (1) 640 06 40
Telex: 57481 MIES E

USA

Marconi Instruments Inc.
13600 Heritage Parkway
Fort Worth
Texas 76117
USA
Telephone: [+1] (817) 224 9200
Fax: [+1] (817) 244 9201

International Service Centres

All Marconi Instruments products are supported by the following network of service centres. Details of these establishments may change from time to time. If you require support please contact your local distributor at the relevant address detailed below. If you experience difficulties, please contact the Customer Support Group - ICS at our Head Office in the UK.

ARGENTINA

V.R. Marine Electronics
(RF Instrumentos)
Tacuman 858 - 6 TO Piso L
(1049) BUENOS AIRES
Republic of Argentina
Telephone: [+54] (1) 311 0424/7432
Fax: [+54] (1) 312 2799
Telex: 21833 JUDD AR

AUSTRALIA

Marconi Instruments (Pty) Ltd
Unit 1
38 South Street
Rydalmere,
NEW SOUTH WALES, 2116
Australia
Telephone: [+61] (2) 638 0800
Fax: [+61] (2) 638 3131

AUSTRIA

LB-Electronics GmbH
Doblinger Hauptstrasse 95
A-1190 WIEN
Austria
Telephone: [+43] (1) 36031
Fax: [+43] (1) 3698443

BANGLADESH

AEI-EE of Bangladesh Ltd
Magnet House 71-72
Dilkusha Commercial Area
DHAKA 1000
Bangladesh
Telephone: [+880] (2) 46031-46037
Fax: [+880] (2) 863278
Telex: 642818 BDI BJ

BELGIUM

Marconi Instrumenten
Van Limburg Stirumlaan 4
5037 SK TILBURG
Postbus 645
5000 AP TILBURG
Netherlands
Telephone: [+31] (13) 4639540
Fax: [+31] (13) 4639663

BOTSWANA

Measuretest cc
Unit 16 Villa Vlencia Office Park
Monument Road
Glen Marais
Kempton Park
Gauteng
South Africa
Telephone: [+27] (11) 396 4502/4/5
Fax: [+27] (11) 396 4510

BRAZIL

Marconi Instruments Inc.
Suite 100
13600 Heritage Parkway
Fort Worth
Texas 76117
USA
Telephone: [+1] (817) 224 9200
Fax: [+1] (817) 224 9201

BRUNEI

Marconi Instruments International Ltd
ASEAN Regional Centre
GEC Building, 3 Tai Seng Drive
SINGAPORE 535216
Telephone: [+65] 381 1470
Fax: [+65] 281 0113

BULGARIA

GOPE Electronics
45 "Popova Shapka" Str
1505 SOFIA
Bulgaria
Telephone: [+359] (2) 708357
Fax: [+359] (2) 708357

CHILE

Morgan & Cia SA
Almirante Pastene 256
Casilla (PO Box) 1-T Tajamar
SANTIAGO
Chile
Telephone: [+56] (2) 236 1278
Fax: [+56] (2) 235 7552

CHINA

Marconi Instruments Service Centre
Department of Electronic Engineering
Beijing Institute of Technology
7 Baishi Qiao Road
BEIJING 100081
Peoples Republic of China
Telephone: [+86] (10) 6842 7954
Fax: [+86] (10) 6842 7954
Telex: 22011 BIT CN

CHINA

Marconi Instruments Service Centre
88 Jiang An Road
SHANGHAI 200233
Peoples Republic of China
Telephone: [+86] (21) 64821947
Fax: [+86] (21) 64821947

COLOMBIA

Selectronica Limitada
Carrera 71 No. 55-98 A.A.25124
Santafe de Bogota
Colombia
Telephone: [+57] (1) 2953215
 [+57] (1) 2631220
Fax: [+57] (1) 2632874

CZECH REPUBLIC

EMPOS Spol. S.R.O.
Rostislavova 13
140 00 PRAHA 4
Czech Republic
Telephone: [+42] (2) 692 50 80
Fax: [+42] (2) 692 50 84

DENMARK

Stantronic Ormhøjgårdvej 16
DK 8700 HORSENS
Denmark
Telephone: [+45] 75 643366
Fax: [+45] 75 644080

EGYPT

Multi-Systems Engineering
21 El Obour Building
Salah Salem, Floor 18
CAIRO
Egypt
Telephone: [+20] (2) 2632771
Fax: [+20] (2) 4028057

FIJI

Marconi Instruments (Pty) Ltd
Unit 1
38 South Street
Rydalmere,
NEW SOUTH WALES, 2116
Australia
Telephone: [+61] (2) 9638 0800
Fax: [+61] (2) 9638 3131

FINLAND

Kaukomarkkinat Oy
Kutojantie 4
P. O. Box 40
SF-02630 ESPOO 63
Finland
Telephone: [+358] (9) 5211
Fax: [+358] (9) 521 5290
Telex: 124469 KAUKO SF

FRANCE

Marconi Instruments SA
18 Rue du Plessis-Briard
"Le Canal"
Courcouronnes
91023 EVRY CEDEX
France
Telephone: [+33] (1) 60 79 96 00
Fax: [+33] (1) 60 77 69 22

GERMANY

Marconi Messtechnik GmbH
Landsberger Strasse 65
D-82110 GERMERING
Germany
Telephone: [+49] (89) 84 9360
Fax: [+49] (89) 84 19142
Telex: 5212642 MMMC D

GREECE

Theodorou Automation SAICT
3 Aftomedontos Street
116 35 Athens
Greece
Telephone: [+30] (1) 7010069
Fax: [+30] (1) 7518829

HUNGARY

MTA-MMSZ Ltd
59-61 Etele ut
H-1119 BUDAPEST
Hungary
Telephone: [+36] (1) 2034298
Fax: [+36] (1) 2034353
Telex: 225114 MTAMM H

ICELAND

Amundason HF
Langholtsvegur 109
P. O. Box 4207
124 REYKJAVIK
Iceland
Telephone: [+354] 5687820
Fax: [+354] 5889318
Telex: 2108 AMCO IS

INDIA

Blue Star Limited
Head Office
Sahas, 414/2 Veer Savarkar Marg
Prabhadevi
BOMBAY 100 025
India
Telephone: [+91] (22) 4306 155 or
[+91] (22) 4306 185
Fax: [+91] (22) 4307 078

INDIA

Blue Star Limited
13 Community Centre
New Friends Colony
NEW DEHLI 110 065
India
Telephone: [+91] (11) 6911 660 or
[+91] (11) 6834 262
Fax: [+91] (11) 6841 845

INDIA

Blue Star Limited
Blue Star House
11 Magarath Road
BANGALORE 560 025
India
Telephone: [+91] (80) 5584 727 or
[+91] (80) 5584 729
Fax: [+91] (80) 5584 599

INDIA

Blue Star Limited
2-2-47, 47/1108,
Bolarum Road
SECUNDERABAD 580 009
India
Telephone: [+91] (40) 842 057 or
[+91] (40) 841 278
Fax: [+91] (40) 841 445

INDONESIA

P.T. Panorama Timur Jaya
J1. Paus 89 D-E
Rawamangun
JAKARTA 13220
Indonesia
Telephone: [+62] (21) 475 6788
Fax: [+62] (21) 475 1688

IRAN

Wavecut Electronics Ltd
PO Box 13185-1341
TEHRAN
Iran
Telephone: [+98] (21) 6436004
Fax: [+98] (21) 540705

IRELAND

Neltronic Ltd
John F. Kennedy Road
Naas Road
DUBLIN 12
Eire
Telephone: [+353] (1) 503560
Fax: [+353] (1) 552789
Telex: 93556 NELT EI

ISRAEL

IES Electronics Agencies (1986) Ltd
32 Ben Gurion Street
RAMAT GAN 52573
Israel
Telephone: [+972] (3) 753 0753 or
[+972] (3) 753 0700
Fax: [+972] (3) 753 0701
Telex: 361396 IES IL

ITALY

Federal Trade SpA
Via Leonardo da Vinci 21/23
20090 Segrate
MILANO
Italy
Telephone: [+39] (2) 2134034/5
Fax: [+39] (2) 2133970

JAPAN

Kikusui Electronics Corp.
1-1-3, Higashiyamata
Tsuzuki-ku
Yokohama City
224-0023
Japan
Telephone: [+81] (45) 593 7580
Fax: [+81] (45) 593 7581

KENYA

GPT Kenya Ltd
Uhuru Highway
P.O. Box 40743
NAIROBI
Kenya
Telephone: [+254] (2) 555011
Fax: [+254] (2) 541556
Telex: 24053

KOREA, SOUTH

Zino International
Youngsung Bldg.
108-4 Samsung-dong
Kangnam-ku
SEOUL 135 091
Republic of Korea
Telephone: [+82] (2) 545 7334
Fax: [+82] (2) 545 7335
Email: allzino@choilian.dacom.co.kr

KUWAIT

Al Nawasi Trading & Contracting Co.
PO Box 3204
13033 SAFAT
Kuwait
Telephone: [+965] 244 7243
Fax: [+965] 241 0473
Telex: 22131 AAA KT

LEBANON

Mabek
P.O. Box 13-5657
BEIRUT
Lebanon
Telephone: [+961] (1) 864479
Fax: [+961] (1) 603129
Telex: 22889 MABEK LE

LIECHTENSTEIN

Isatel Emitec AG
Hinterbergstrasse 9
6330 CHAM
Switzerland
Telephone: [+41] (42) 41 80 41
Fax: [+41] (42) 41 80 43

LUXEMBOURG

Marconi Instrumenten
Van Limburg Strumiaan 4
5037 SK TILBURG
Postbus 645
5000 AP TILBURG
Netherlands
Telephone: [+31] (13) 639540
Fax: [+31] (13) 639663

MACAU

Marconi Instruments International Ltd
Room 702-703
CC Wu Building
302-308 Hennessy Road
WANCHAI
Hong Kong
Telephone: [+852] 2832 7988
Fax: [+852] 2834 5773

MALAYSIA

Mahkota Technologies Sdn Bhd
Wisma Mahkota
Jalan 215-Templer
46050 PETALING JAYA
Selangor, Malaysia
Telephone: [+60] (3) 791 1388
Fax: [+60] (3) 792 1350 or
[+60] (3) 791 1886
Telex: 37617 GECMYA MA

NAMIBIA

Measuretest cc
P.O. Box 6301
DUNSWART 1508
Transvaal
Republic of South Africa
Telephone: [+27] (11) 894 7721
Fax: [+27] (11) 894 6414
Telex: 747651 MTEST SA

NETHERLANDS

Marconi Instrumenten
Van Limburg Strumiaan 4
5037 SK TILBURG
Postbus 645
5000 AP TILBURG
Netherlands
Telephone: [+31] (13) 463 95 40
Fax: [+31] (13) 4639663

NEW ZEALAND

Components & Instrumentation N.Z.
Ltd
P. O. Box 38099
Wellington Mail Centre
19-21 Pretoria Street
LOWER HUTT
New Zealand
Telephone: [+64] (4) 566 3222
Fax: [+64] (4) 566 3722

NIGERIA

General Telecom Ltd
18 Moloney Street
P.O. Box 2213
LAGOS
Nigeria
Telephone: [+234] (1) 2645530
Fax: [+234] (1) 2645529

NORWAY

Nortronicom a/s
P.O. Box 33
Manglerud
0612 OSLO 6
Norway
Telephone: [+47] (22) 68 09 10
Fax: [+47] (22) 68 18 87
Telex: 77140 NM M

OMAN, SULTANATE OF

Suhail & Saud Bahwan
PO Box 169
MUSCAT
Sultanate of Oman
Telephone: [+968] 793741
Fax: [+968] 796158
Telex: 3585 BAHWAN ON

PAKISTAN

Intermark Ltd
P.O. Box 6159
Hakimsons Building
19 West Wharf Road
KARACHI 74000
Pakistan
Telephone: [+92] (21) 201725
Fax: [+92] (21) 231 04801
Telex: 23649 YAQIN PK

PHILIPPINES

Sunley Inc
8/F RCI Building
105 Rada Street
Legaspi Village
Makati
METRO MANILA
Philippines
Telephone: [+63] (2) 818 1216
Fax: [+63] (2) 815 0730
Telex: 62098 MANILA PN

POLAND

Interlab P.U.H.
Ul. Potocka 14, PAW 3
01-641 WARSAW
Poland
Telephone: [+48] (22) 333961 or
[+48] (22) 333956
Fax: [+48] (22) 3332260 or 333956

PORTUGAL

Pinto Basto Electrotecnia e Maquinas
Ltda
Av. 24 de Julho
3-1 Esq
1200 LISBON
Portugal
Telephone: [+351] (1) 3972041
Fax: [+351] (1) 3972595
Telex: 16819 SOCIL P

QATAR

Business Communications Qatar Ltd
PO Box 150
DOHA
Qatar
Telephone: [+974] 325851
Fax: [+974] 414100
Telex: 4219 JAIDAH DH

SAUDI ARABIA

Electronic Equipment Marketing Co
P.O. Box 3750
RIYADH 11481
Kingdom of Saudi Arabia
Telephone: [+966] (1) 477 1650
Fax: [+966] (1) 478 5140
Telex: 401120 ZUHAI R SJ

SAUDI ARABIA

Electronic Equipment Marketing Co
Al Badariah Centre
3rd Floor, Suite 202
Pepsi Coal Road
AL KHOBAR
Kingdom of Saudi Arabia
Telephone: [+966] (3) 859 1888
ext 717
Fax: [+966] (3) 859 1888 ext 617

SAUDI ARABIA

Electronic Equipment Marketing Co
Abu Al-Fadel-Street
Palestin Road
JEDDAH
Kingdom of Saudi Arabia
Telephone: [+966] (2) 6652146
Fax: [+966] (2) 6655804

SINGAPORE

Marconi Instruments International Ltd
ASEAN Regional Centre
GEC Building
3 Tai Seng Drive
SINGAPORE 535216
Telephone: [+65] 381 1470
Fax: [+65] 281 0113
Telex: 36370 GECRSRS

SLOVAKIA REPUBLIC

EMPOS s.r.o.
Rostislavova 13
140 00 PRAHA 4
Czech Republic
Telephone: [+38] (2) 692 50 80
Fax: [+38] (2) 692 50 84

SLOVENIA

SIQ
SI-61000
LJUBLJANA
Slovenia
Trzaska c.2
Telephone: [+386] 61 1258 212
Fax: [+386] 61 218 020
Telex: 31 265 YU ZAVTOM

SOUTH AFRICA

Measuretest cc
Unit 16 Villa Vlencia Office Park
Monument Road
Glen Marais
Kempton Park
Gauteng
South Africa
Telephone: [+27] (11) 396 4502/4/5
Fax: [+27] (11) 396 4510

SPAIN

Marconi Instrumentos S.A.
Europa Empresarial
C/Rozabella, No. 6
Edif. Paris, Planta Baja, Oficina 1
28230 LAS ROZAS
Madrid, Spain
Telephone: [+34] (1) 640 11 34
Fax: [+34] (1) 640 06 40
Telex: 57481 MIES E

SWEDEN

Pronesto AB
Box 6014
164 06 KISTA
Sweden
Telephone: [+46] (8) 444 1050
Fax: [+46] (8) 751 41 11
Telex: 19270 PROS

SWITZERLAND

Emitec AG
Hinterbergstrasse 9
6330 CHAM
Switzerland
Telephone: [+41] 41 748 60 10
Fax: [+41] 41 748 50 55

TAIWAN

HWA Jeat Corp.
6F-3, No. 181 Fu-Hsing N. Road
TAIPEI 10441
Taiwan
Republic of China
Telephone: [+886] (2) 719 3216
Fax: [+886] (2) 719 2886
Email: hjctwn@ms2.hinet.net

THAILAND

Yip in Tsoi & Jacks Ltd
523 Mahaprutharam Road
P.O. Box 2611
BANGKOK 10501
Thailand
Telephone: [+66] (2) 639 0369
Fax: [+66] (2) 236 5693
Telex: 82929 YIPJACKS TH.

TURKEY

Orko Mumessiliik
Tunus Caddesi 85/9
06680 Kavaklidere
ANKARA
Turkey
Telephone: [+90] (312) 426 6047
Fax: [+90] (312) 426 6180
Telex: 44498 OKAS TR

UAE ABU DHABI

Bahwan Trading Company (LLC)
P O Box 41175
Abu Dhabi
Telephone: [+971] (2) 768909
Fax: [+971] (2) 768907

UAE DUBAI

Bahwan Trading Company (LLC)
P O Box 25173
Dubai (Head Office)
Telephone: [+971] (4) 553883
Fax: [+971] (4) 553776

UNITED KINGDOM

Marconi Instruments Ltd
The Airport
LUTON
Bedfordshire LU2 9NS
United Kingdom
Telephone: [+44] (1582) 33866
Fax: [+44] (1582) 417573

URUGUAY

Telefax Telecomunicaciones Colonia
968
11100 Montevideo
Uruguay
Telephone: [+598] (2) 920082
Fax: [+598] (2) 921581

USA

Marconi Instruments Inc.
13600 Heritage Parkway
Fort Worth
Texas 76117
USA
Telephone: [+1] (817) 224 9200
Fax: [+1] (817) 244 9201

VENEZUELA

Marcoms De Venezuela C.A.
Edif Exagon Piso 5 OFC 57
Av Romulo Gallegos El Marques
Apartado 76702
CARACAS 1070A
Venezuela
Telephone: [+58] (2) 242 1110 or
[+58] (2) 242
1590
Fax: [+58] (2) 238 0068 or
[+58] (2) 242 0241
Telex: 23049 DHMAR VC

VIETNAM

East Asiatic Company Ltd A/S,
Ho Chi Minh City Representative
Office
17 Ton Duc Thang Street, 2nd Floor
HO CHI MINH CITY
Vietnam
Telephone: [+84] (8) 8290499
Fax: [+84] (8) 8230014

ZIMBABWE

Measuretest cc
Unit 16 Villa Vlencia Office Park
Monument Road
Glen Marais
Kempton Park
Gauteng
South Africa
Telephone: [+27] (11) 396 4502/4/5
Fax: [+27] (11) 396 4510

INST 26/5/98